

INDICE ALFABETICO

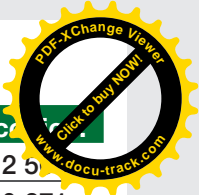

| A | da codice: |
|--|-------------------|
| Asiavi (Vedi anche nastri abrasivi e smerigliatrici) | 512 5 |
| Alesametri | 510 271 |
| Alesatori | 512 001 |
| Aerografi (Maschere anti polvere . Cuffie - Arrotolatori) | 515 461 |
| Air.bag | 230 000 |
| Alternatori (Vedi anche messa in fase) | 215 679 |
| Alzavalvole: Piattelli - Smerigliavalvole - Paste - Adattatore soffiaggio aria per prova valvole | 213 145 |
| Ammortizzatori (Comprimi molla manuali - pneumatici) | 234 000 |
| Argani (vedi anche paranchi e carrucole) | 520 191 |
| Artigli e relativi Prenditutto - Vaschette magnetiche - Ascoltarumori - Specchietti | 211 001 |
| Aspirapolveri - Aspira liquidi - Aspiracenere | 517 560 |
| Aspira / Recupero olio esausto e relativi Imbuti - Vasche - Cisterne doppia camera | 514 230 |
| Aspirafumi per officina | 515 800 |
| Astine olio | 217 450 |
| Attrezzi per pistoncini freno | 235 120 |
| Autocarri: attrezzi vari | 301 041 |
| Autoradio: attrezzi per estrazione e relativi kit di terminali | 251 010 |
| Avviatori: Macchine / Camion e relativi caricabatteria / mantenitori di carica | 251 221 |
| Avvitatori pneumatici | 516 001 |
| Avvolgitubo per aria / acqua | 515 498 |
| Avvolgicavo e relative Multiprese, Spine, Prese | 517 001 |
| Avvolgicavo con e senza portalamпада | 251 328 |

| B | da codice: |
|--|-------------------|
| Banchi da lavoro con e senza cassette con relativi pannelli, ganci ecc | 520 043 |
| Bloccasterzo e relativi lucchetti, cinghie di ancoraggio | 521 924 |
| Bombolette spray (WD40 - Grasso - Pulitor freni, frizioni, carburatori - Grasso - Nero gomme ecc..) | 512 488 |
| Borse porta utensili | 523 001 |
| Braccetti-sterzo | 231 008 |
| Brucciatori per saldatori a gas e relative macchine per varie saldature e protezioni | 513 690 |
| Bulini e relativi cacciaspine, punzoni, unghiette, scalpelli | 417 055 |
| Bussole per cricchetto e relativi criccheti, prolunghe, snodi, adattatori | 414 001 |
| Bussole per avvitatore e relativi snodi, prolunghe, adattatori (Vedi anche Pneumatica) | 414 470 |
| Bussole con inserto | 414 640 |
| Bussole per dadi ruota e prigionieri danneggiati | 232 100 |
| Bussole per ghiera e chiavi a compasso | 413 653 |
| Bussole per ghiera mozzo: | 232 018 |
| Bussole per mezzi commerciali e relativi attrezzi | 301 046 |

| C | da codice: |
|---|-------------------|
| Cacciaviti / Microcacciaviti | 410 001 |
| Cacciaviti dinamometrici | 415 802 |
| Cacciaviti pneumatici | 516 171 |
| Cacciaspine e relativi punzoni, bulini ecc.. | 417 055 |
| Calibri - Flessometri - Micrometri - Goniometri - Spessimetri | 510 201 |
| Carica batteria e relativi Avviatori - Mantenitori di carica - Pinze - Cavi ecc.. | 251 201 |
| Carrelli per utensili | 522 034 |
| Carrelli e vasche portafusti | 514 233 |
| Carrozzeria (Leve - Ganci - Convogliatori aria calda - Pinze foralamiera - Martelli - Tassi - Ventose ecc..) | 240 000 |
| Carrucole (Vedi anche argani e paranchi) | 516 291 |
| Carta abrasiva (nastro) | 516 193 |

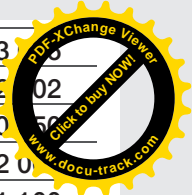
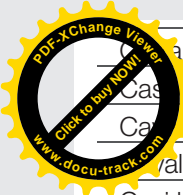

| | |
|---|------------|
| Carte abrasive, rotolo, tela, anelli | 513 000 |
| Caschi e cascate portautensili | 522 002 |
| Caricabatterie per moto | 700 050 |
| Caricabatterie per camion, camioncini, trattori, trattorini, valletti sostegno motore, colonnette (Vedi anche cric) | 522 000 |
| Cavi batteria e relative Pinze - Avviatori - Mantentori di carica ecc.. | 251 100 |
| Cazzuole | 525 101 |
| Centrafari | 251 281 |
| Centrafrizioni | 221 001 |
| Cercafase | 410 330 |
| Cesoie | 416 651 |
| Cesoie pneumatiche | 516 231 |
| Cestelli lavaggio e relative vasche di lavaggio (Vedi anche vasche a ultrasuoni) | 514 920 |
| Chiavi: Fisse / Aperte / Combinare / Cricchetto / Torx femmina / Fisse / Poligonali / Percussione | 413 001 |
| Chiavi a brugola e relative serie | 412 061 |
| Chiavi a bussola per cricchetto e relativi cricchetti, snodi, prolunghe | 414 001 |
| Chiavi a bussole per avvitatore e relativi snodi, prolunghe, adattatori (Vedi anche Pneumatica) | 414 470 |
| Chiavi a bussola per mezzi commerciali e relativi attrezzi | 301 046 |
| Chiavi a bussola per dadi ruota e prigionieri danneggiati | 232 100 |
| Chiavi a bussole per ghiera e chiavi a compasso | 413 653 |
| Chiavi a bussola per mozzi ruota | 232 018 |
| Chiavi per braccetti sterzo | 231 008 |
| Chiavi a cricchetto | 413 401 |
| Cricchetti reversibili per bussole e per nippli | 414 400 |
| Chiavi candela / Candelette | 213 001 |
| Chiavi a croce e relativi attrezzi per ruote | 233 001 |
| Chiavi dinamometriche (Vedi anche cacciaviti dinamometrici) | 415 592 |
| Chiavi per filtro / Coppa olio / sonda lambda | 217 000 |
| Chiavi per ghiera galleggiante serbatoio | 212 601 |
| Chiavi iniettori | 212 100 |
| Chiavi a rullino | 413 611 |
| Chiavi a settore | 413 701 |
| | 412 401 |
| | 413 722 |
| Chiavi a "T" Maschio / Femmina / Esagonale / Torx | 414 340 |
| | 415 100 06 |
| | 415 150 02 |
| Chiavi a Tubo / Pipa | 415 301 |
| Chiavi punterie | 213 602 |
| Chiavi per ponteggi | 413 298 |
| Chiavi sottolavello | 417 761 |
| Ciabatte e relative Spine, Avvolgicavo | 517 001 |
| Cinghie ancoraggio/Traino | 521 931 |
| Ciotole magnetiche e relativi Prenditutto - Ascoltarumori - Specchietti | 211 040 |
| Climatizzatori / Radiatori | 216 000 |
| Colonnette sostegno veicoli | 522 011 |
| Coltello / pinza per cavi | 416 565 |
| Comparatori / portacomparatori | 213 550 |
| Compressori a leva per olio e grasso | 514 082 |
| Coni morse | 511 001 |
| Contafiletti | 510 401 |
| Contrappesi (Bussole - Crociere - Pezze) | 233 300 |
| Cricchetti per bussole | 414 400 |
| Cricchetti pneumatici | 516 101 |
| Cric: Sottovettura / Fossa / Bottiglia (Gru idrauliche - Presse) | 520 400 |

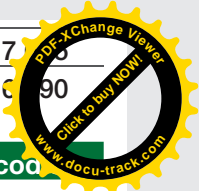
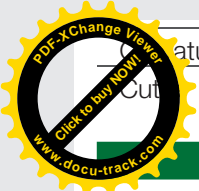

| | |
|---|---------|
| Giratubi | 417 601 |
| Giraviti | 410 001 |
| da codice: | |
| Demineralizzatore | 216 150 |
| Densimetri antigelo | 216 101 |
| Densimetri batteria | 251 026 |
| Dinamometri angolari | 213 720 |
| Dinamometriche | 415 600 |
| Dischi abrasivi / Taglio / Lamellari - Mole | 513 001 |

| | | |
|---|---------|-------------------|
| E | | da codice: |
| Elicoil / fietti riportati e relativi posatori | 512 281 | |
| Endoscopi | 251 501 | |
| ESTRATTORI: 2 / 3 zampe / Autoserranti / Cuscinetti interni - esterni / Perni sferici / Prigionieri | 111 001 | |
| Estrattori braccetti sterzo | 231 008 | |
| Estrattori cuscinetti / piste cuscinetti (Trio / Simo) | 232 004 | |
| Estrattori per giunti omocineticici | 232 130 | |
| Estrattore Iniettori | 212 124 | |
| Estrattori Mozzi | 232 010 | |
| Estrattori paraolii | 214 032 | |
| Estrattori silent block | 234 202 | |
| Estrattore Tamburo freno | 335 100 | |
| Estrattori per viti danneggiate | 232 100 | |
| Estrattori volano | 214 310 | |

| | | |
|--|---------|-------------------|
| F | | da codice: |
| Fasce pistoni | 214 010 | |
| Fascette click e relative pinze | 212 020 | |
| Fascette: Giunti / Cuffie | 223 061 | |
| Fascette: Plastica / Stringitubo | 521 481 | |
| Filetti riportati | 512 281 | |
| Filiere - maschi e relativi kit | 511 801 | |
| Filiere per tubi | 417 769 | |
| Flessometri / Metri | 510 016 | |
| Foratrici pneumatiche | 516 233 | |
| Forbici professionali | 416 100 | |
| Freni: Spurgafreni, Tappi, Chiavi, estrattori ecc.. (Vedi anche rettifica freni MAD 235 300) | 234 907 | |
| Frese Coniche / Rotative | 512 041 | |
| Frese iniettori | 212 349 | |
| Frizioni, Centrafrizioni e relativi estrattori | 221 001 | |
| Funi di sollevamento e relative cinghie | 521 931 | |
| Fustelle | 416 902 | |

| | | |
|--|---------|-------------------|
| G | | da codice: |
| Ganci per pannelli e relativi pannelli con e senza mensola | 522 090 | |
| Giramaschi / filiere | 511 931 | |
| Giratubi | 417 601 | |
| Giraviti e micro giraviti | 410 001 | |
| Giraviti dinamometrici | 415 802 | |
| Giraviti a percussione | 516 171 | |
| Golfare / Grilli | 521 671 | |
| Gonfiagomme (Pistole / Sebatoi) | 515 408 | |
| Goniometri | 213 720 | |

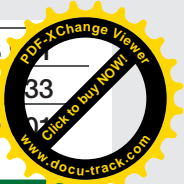
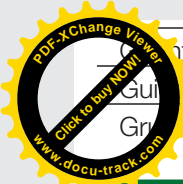

| | |
|---|--------|
| nti: Pelle - Nitrile - Doppio lattice - Showa - Per sabbare - Per spurghi ecc | 513 |
| Gul porta bussole e relative bussole | 414 33 |
| Gruppi idrauliche | 520 |

| I | da codice: |
|---|-------------------|
| Imbuti | 514 141 |
| Imbuti olio | 217 441 |
| Incudini | 520 101 |
| Ingrassatori manuali e pneumatici | 514 301 |
| Inseri / Porta inseri e relativi kit | 411 001 |
| Innesti (Rapidi / Spirali / Tubi / Pistole gonfoaggio / soffiaggio) | 515 101 |

| L | da codice: |
|---|-------------------|
| Lame: Seghetto/Cutter/Sbavatori | 416 821 |
| Lame per seghetti pneumatici | 516 253 |
| Lampade portatili - Con cavo - Avvolgitori | 251 300 |
| Lampada con raggi UV per perdite A/C e relativi attrezzi | 216 085 |
| Lampadine per auto / camion | 800 001 12 |
| Lava motori | 514 930 |
| Lettini sottovettura | 522 019 |
| Levabolli pneumatico (Vedi Pneumatica) | 516 273 |
| Levagomme | 415 440 |
| Leve per carrozzieri (Ganci - Convogliatori aria calda - Pinze foralamiera - Martelli - Tassi - Ventose ecc..) | 240 000 |
| Levigatori cilindrici | 214 038 |
| Levigatrici pneumatiche | 516 181 |
| Lime | 512 505 |
| Liquido perdite guarnizioni testate e relativi attrezzi | 214 301 |
| Liquido tracciante per A/C e relativi attrezzi | 216 086 |
| Livelle e relative Squadre, Punzoni, Calibri ecc.. | 510 051 |
| Livelle per volanti | 231 015 |
| Lubrificatori e riduttori di pressione | 515 031 |
| Lucida / ripristina fari | 242 100 |
| Lucchetti | 521 901 |

| M | da codice: |
|--|-------------------|
| Mandrini | 511 500 |
| Manometri - Vuotometri | 252 001 |
| Martinetti - Cric | 520 301 |
| Martelli - Mazzette - Mazzuole | 417 201 |
| Martelli per carrozzeria | 241 530 |
| Martelli per spianare pneumatici | 516 271 |
| Maschere saldatura e relativi articoli per saldare, inverter, filo continuo (vedi anche occhiali di protezione) | 513 825 |
| Maschere antipolvere | 515 495 |
| Maschi / Filiere | 511 601 |
| Messa in fase: Cavallotti - Dischi graduati - Kit di fasatura - Tendicinghia - Kit alternatori - Pinze manicotti | 215 001 |
| Metri / Micrometri | 510 001 |
| Microgiraviti, giraviti | 410 001 |
| Misurini e relative taniche e imbuti | 514 131 |
| Misuratori laser termometro | 253 502 |
| Mole / Smerigliatrice | 512 780 |
| Moltiplicatori di coppia (Vedi anche moltiplicatore di coppia per camion 335 200) | 415 574 |
| Morse e incudini | 520 001 |
| Morse per tubisti | 417 851 |
| Morsetti a cavallotto e morsetti per falegname / meccanica | 521 671 |

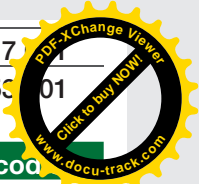
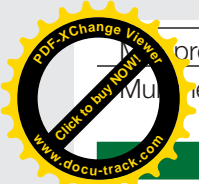

| | |
|--|------------|
| Prese - Prese - Aspirapolveri - Avvolgicavo (vedi anche avvolgicavo portalamпада) | 517 001 |
| Multimetri e relativi tester, pinze amperometriche, rilevatori segnale, pistole stroboscopiche, tester batterie | 253 001 |
| da codice: | |
| Nastri abrasivi e relative smerigliatrici (vedi anche Abrasivi) | 516 193 |
| Nebulizzatore / Schiumogeni | 514 928 |
| O da codice: | |
| Occhiali di protezione (Vedi anche maschere con macchinari per saldatura) | 513 861 |
| Olio impianti A/C | 216 087 |
| Oliatori / Distributori olio | 514 001 |
| O-Ring / Rodelle rame, rame toroidali, alluminio, con gomma | 521 430 |
| P da codice: | |
| Pannelli portautensili con e senza mensola con relativi ganci | 522 090 |
| Paranchi (Vedi anche argani e carrucole) | 521 131 |
| Pennelli | 522 131 |
| Pesi per ruote e relativi Contrappesi - Bussole - Crociere - Pezze - valvole tubbles ecc.. | 233 300 |
| Piattelli punterie: Alzavalvole - Smerigliavalvole - Paste - Adattatore soffiaggio aria per provavalvole | 213 320 |
| Pile | 600 010 |
| Pinze amperometriche, multimetri, rilevatori segnali, pistole strobo, tester batterie, termometro laser | 253 001 |
| Pinze: Becchi / Seeger / Grip / Autobloccanti / Capicorda / Grip / Torcifilo | 416 001 |
| Pinze cappucci candele | 213 078 |
| Pinze a espansioni | 141 001 |
| Pinza / coltello per cavi | 416 565 |
| Pinze fascette click e relative fascette | 212 020 |
| Pinze fascette a nastro e fascette | 223 109 |
| Pinze foralamiere e relativo materiale per carrozzeria | 241 600 03 |
| Pinza fustellatrice e fustelle | 416 901 |
| Pinze per ruote e relativo materiale per gommisti | 233 090 |
| Pinze tubi carburante | 212 001 |
| Piombi bilanciatura - Pezze - Bussole per dadi ruote - Dadi viti danneggiate - Cocchiere ecc.. | 233 300 |
| Pistole per colle a caldo | 521 948 |
| Pistole Gonfiaggio / Soffiaggio | 515 400 |
| Pistole lavaggio e relative vasche di lavaggio, schiumogeni, lavamotori | 514 901 |
| Pistole gasolio, olio, , grasso | 514 130 06 |
| Pistole per sabbare e relative sabbiatrici e sabbie | 515 000 |
| Pistole soffiaggio e gonfiaggio | 515 400 |
| Pistole silicone (vedi anche pneumatica) | 521 953 |
| Pistole stroboscopiche | 253 378 |
| Pistola Termiche / Phon (Vedi anche carrozzeria)5 | 241 105 |
| PNEUMATICA (Lubrificatori, Riduttori - Innessi - Spirali, Tubi - Soffiaggio. Gonfiaggio. - Arrotolatori) | 515 031 |
| PNEUMATICA (Avvitatori ruote - Cricchetti - Trapani - Smerigliatrici - Levigatrici - Staccapunti - Avvitatori - Cacciaviti - Levigatrici - Smerigliatrici - Scalpelli - Seghetti - Staccavetri - Rivettatrici - Carucole - Olio) | 516 001 |
| Polvere assorbimento acido 251 150 | 251 150 |
| Polvere assorbimento Olio, Acqua, Grasso | 514 940 |
| Pompe grasso, manuali e pneumatiche | 514 301 |
| Pompe taratura iniettori | 212 210 |
| Pompe idrauliche, Gru, Crick | 520 301 |
| Pompe travaso (Attrezzi manuali - Pneumatici per olii e liquidi vari) | 514 118 |
| Pompe alternative manuali per benzina | 514 125 15 |
| Portacomparatori | 211 411 |
| Posatori elicoil e relativi filetti riportati | 512 281 |
| Prenditutto - Specchietti - Vaschette magnetici | 211 001 |

| | |
|--|---------|
| Prese elettriche e relative Ciabatte, Avvolgicavo | 517 000 |
| Prese idrauliche e relative Gru, Crick ecc.. | 520 001 |
| Prese per molli ammortizzatori (Manuali - Pneumatiche) | 234 000 |
| Prova radiatori | 216 000 |
| Prova compressione / pressione | 252 001 |
| Pulegge, vari attrezzi per | 215 091 |
| Punta a tracciare | 512 200 |
| Punte da trapano | 511 111 |
| Punzoni e relativi cacciaspine bilini ecc.. | 417 055 |

R **da codice:**

| | |
|--|---------|
| Raccordi aria e relative pistole, tubi e spirali (vedi anche pneumatica) | 515 101 |
| Rabboccatori per batterie e relativo materiale vario | 251 011 |
| Radiatori / Raffreddamento | 216 000 |
| Raschietti e taglierini | 416 875 |
| Ravviva filetti | 512 275 |
| Recupero/Aspira olio esausto | 514 241 |
| Riduttori di pressione e lubrificatori | 515 031 |
| Rivettatrici / Rivetti | 520 811 |
| Roditrici pneumatiche | 516 245 |
| Rondelle Parafiamme | 212 308 |
| Rondelle Rame, toroidali, Acciaio, Alluminio - O-ring | 521 430 |

S **da codice:**

| | |
|--|---------|
| Sabbiatrici / Sabbia | 515 000 |
| Saldatori a Gas, Elettrici e relative maschere, occhiali di protezione - guanti | 513 580 |
| Sbavatori | 416 851 |
| Scaffali porta-minuterie e relativi Carrelli, Banchi, Mensole ecc | 522 025 |
| Scaffali stoccaggio gomme | 522 150 |
| Scalpelli, Cacciaspine, Martelli | 417 001 |
| Scalpelli pneumatici | 516 201 |
| Schiumogeno e relativi Nebulizzatori, Vasche lavaggio, Rulli spremi pelle ecc.. | 514 928 |
| Seghetti / Lame | 416 800 |
| Seghetti pneumatici | 516 251 |
| Seghe a tazza | 512 071 |
| Silent block, estrattori / introduttori vari | 234 202 |
| Sincro/Vuotometro:Carburatori | 252 530 |
| Siringhe per olio e relative Pompe olio, gasolio | 514 081 |
| Siringa silicone pneumatica | 516 278 |
| Smaglia-catene | 218 000 |
| Smerigliatrici pneumatiche | 516 131 |
| Smerigliatrici da banco - a colonna e relative spazzole (vedi anche Pneumatica) | 512 780 |
| Smerigliavalvole: Alzavalvole - Piattelli - Paste - Adattatore soffiaggio aria per prova alzata valvole | 213 145 |
| Smonta ammortizzatori (Manuali - Pneumatici) | 234 000 |
| Sollevatori (Crick idraulici acarrello, a bottiglia - da fossa) + OMCN (Per moto vedi art.520 440, linea moto) | 522 011 |
| Sonde lambda | 217 490 |
| | 214 001 |
| Sostegni motore (Staffe, Orbital e Cavalletti) | 520 470 |
| | 522 001 |
| Spatole per stuccatori | 525 501 |
| Spazzole: Smerigliatrici, Mole, Scovoli Acciaio / Ottone / Inox | 512 780 |
| Spellacavi / Spellafili, Pinze terminali ecc.. | 416 501 |
| Specchietti e relativi Prenditutto - Vashette magnetiche - Ascoltarumori | 211 001 |
| Spessimetri e Relativi contafiletti e Calibri | 510 401 |

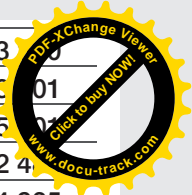
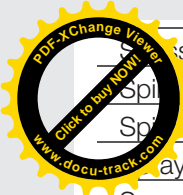

| | |
|--|---------|
| Sforzi punterie | 213 |
| Spirometri e relativi tester per diagnosi | 253 01 |
| Spiri rilsan - poliuretano (Innesti - Rapidi / Tubi / Pistole gonfiaggio / soffiaggio) | 515 |
| Spray / Detergenti/ Adittivi | 512 4 |
| Spremi-pelle | 514 935 |
| Spurgofreni | 234 907 |
| Squadre e livelle | 510 051 |
| Strettoi: Falegname / Meccanica | 521 772 |
| Stacca-punti / Vetri pneumatici | 516 165 |
| Svasatui | 417 690 |
| Supporto magnetico per avvitatori | 516 070 |

T **da codice:**

| | |
|--|--------------------|
| Tagliabulloni | 416 272 |
| Tagliacavi - tagliatubi (pinza - coltello) | 416 565 |
| Taglierini | 416 890 |
| TAMPONI per ponti / stazionamento | 520 600 |
| Tassi per carrozzeria (Ganci - Convogliatori aria calda - Pinze foralamiera - Martelli - Ventose ecc..) | 241 500 |
| Tappi olio e relativi attrezzi | 217 400 |
| Tela / carta abrasiva | 513 076 |
| Tenaglie | 516 251 |
| Tendicinghia | 215 570 |
| Tenditori e relativi Cavallotti, golfari, Morsetti | 521 751 |
| Termometri radiatori e puntatori laser | 216 032 253 502 |
| Tester automotive (Termometri digitali - Multimetri - Rilevatori di segnali - Tester batterie ecc..) | 253 001 |
| Tester pompe olio | 252 045 |
| Traccialinee e polveri | 525 070 |
| Trapani pneumatici | 516 121 |
| Travasatori e relativi Imbuti, bacinelle | 514 171 |
| Traversa sostegno motore (Vedi anche cavalletti sostegno / rotazione motore) | 214 001 |
| Tronchesi e relative Tenaglie, tagliabulloni | 416 198 |
| Troncatrice a disco pneumatica | 516 240 |
| Tubi rilsan- poliuretano (Innesti - Rapidi / Pistole gonfoaggio / soffiaggio) | 515 101 |
| Truschini | 510 091 |

V **da codice:**

| | |
|---|---------|
| Valige / Cassette portautensili | 522 202 |
| Valvole tubless e materiale vario per gommisti | 233 601 |
| Valvole / Alzavalvole | 213 145 |
| Vaporizzatori | 514 650 |
| Vaschette ultrasuoni per iniettori riscaldanti e non | 212 390 |
| Vasche lavaggio pneumatiche e relativi Lavamotori / Schiumogeni | 514 920 |
| Vaschette magnetiche e relativi Prenditutto - Specchietti - Ascoltarumori | 211 001 |
| Vasche di contenimento fusti - Carrelli porta-fusti - Cisterne doppia parete | 514 230 |
| Ventose e erelativo materiale per carrozzieri | 241 043 |
| Vetri inattinici e occhiali di protezione (Vedi anche maschere per saldatura) | 513 861 |
| Vuotometro-Sincronizzatore vuotometro Carburatori | 252 530 |

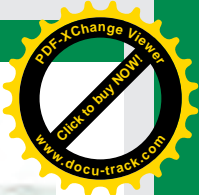
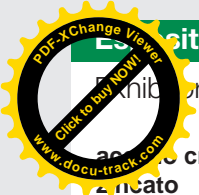

Estrattori a 2 zampe, modello A.F.A, con piede a punta conica sottile

Universal pullers 2 conical point legs

acciaio cr. v.
zincato



codice

111 000 espositore AFA - pz. 6

art. composizione - composition

111 001 estrattore 2 zampe mm. 65 x 65

111 002 estrattore 2 zampe mm. 70 x 80

111 003 estrattore 2 zampe mm. 84 x 112

111 004 estrattore 2 zampe mm.100 x 130

111 005 estrattore 2 zampe mm.130 x 165

111 006 estrattore 2 zampe mm.250 x 260

Estrattori universali a 2 zampe con piede a punta conica sottile

Universal puller 2 conical point legs

acciaio cr. v.
zincato



| codice | A | B | C | vite | gr. |
|---------|----|----|---|--------------|-----|
| 111 001 | 65 | 65 | 8 | 10x1.25xh.90 | 300 |

Ricambi per codice 111 001

Spare parts



zampa (singola con rondella e dado)
codice 111 021



traversa
codice 111 040



vite
codice 111 061

Adattatori opzionali

Optional adaptor

Prolunga per codice 111 001

acciaio fosfatato

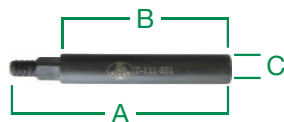

| codice | A | B | C | filetto |
|---------|-----|----|----|---------|
| 111 031 | 105 | 81 | 14 | 8x1.25 |

Prolunga completa di zampa per codice 111 001



| codice | composizione | D |
|------------|-------------------|-----|
| 111 031 10 | 111 031 + 111 021 | 145 |

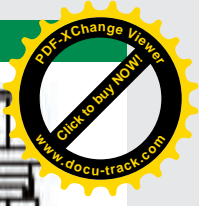
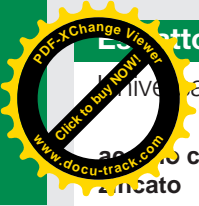

Attori universali a 2 zampe nervate con piede a punta sottile

Universal puller with twin ribbed point legs

2010 cr. v.
Sato

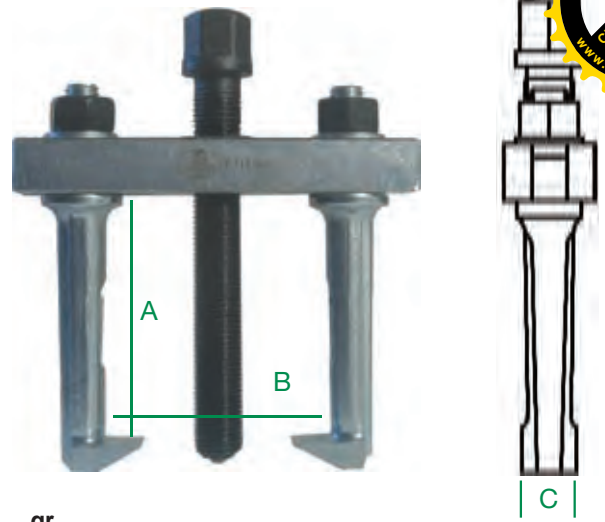

| codice | A | B | C | vite | gr. |
|---------|-----|-----|----|------------------|------|
| 111 002 | 70 | 80 | 15 | 14 x 1.5 x h.105 | 600 |
| 111 003 | 84 | 112 | 18 | 16 x 1.5 x h.130 | 1150 |
| 111 004 | 100 | 130 | 21 | 18 x 1.5 x h.160 | 1700 |
| 111 005 | 130 | 165 | 24 | 20 x 1.5 x h.185 | 2650 |

Ricambi

Spare parts



| per codice | zampa (singola con rondella e dado) | traversa | vite |
|------------|-------------------------------------|----------|---------|
| 111 002 | 111 022 | 111 042 | 111 062 |
| 111 003 | 111 023 | 111 043 | 111 063 |
| 111 004 | 111 024 | 111 044 | 111 064 |
| 111 005 | 111 025 | 111 045 | 111 065 |

Adattatori opzionali

Optional adaptor

Prolunga

acciaio fosfatato

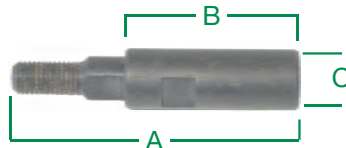

Prolunga completa di zampa

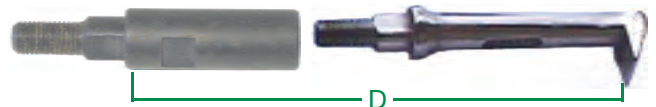

| per codice | codice | A | B | C | filetto | codice | composizione | D |
|------------|------------|-----|-----|----|---------|------------|----------------------|-----|
| 111 002 | 111 032 | 80 | 50 | 20 | 10x1.5 | 111 032 10 | 111 032 + 111 022 | 120 |
| 111 003 | 111 033 01 | 100 | 60 | 21 | 12x1.5 | 111 033 10 | 111 033 01 + 111 023 | 144 |
| 111 003 | 111 033 02 | 140 | 100 | 27 | 12x1.5 | 111 033 11 | 111 033 02 + 111 023 | 185 |
| 111 005 | 111 035 01 | 121 | 71 | 27 | 16x1.5 | 111 035 10 | 111 035 01 + 111 025 | 276 |
| 111 005 | 111 035 02 | 195 | 146 | 30 | 16x1.5 | 111 035 11 | 111 035 02 + 111 025 | 276 |

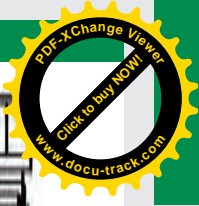
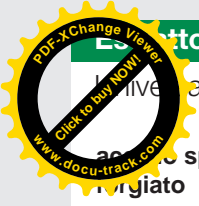

Estrattori universali a 2 zampe con piede a punta sottile

Universal puller twin point leg

30% speciale
lavorato

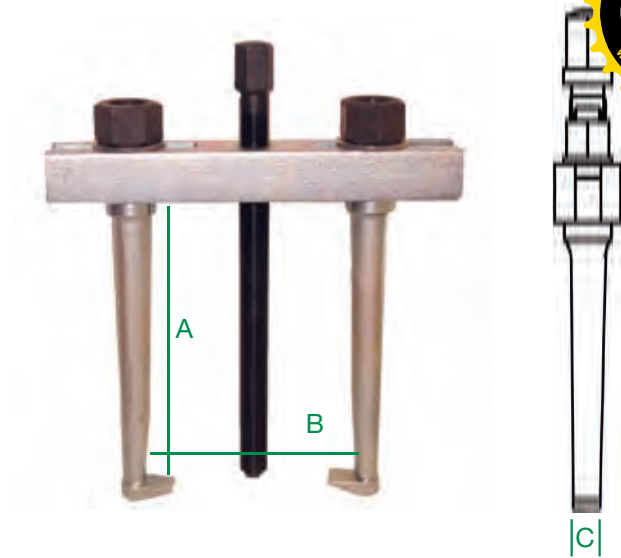

| codice | A | B | C | vite | gr. |
|---------|-----|-----|----|------------|------|
| 111 006 | 250 | 260 | 24 | 24x2xh.310 | 7800 |
| 111 007 | 290 | 300 | 27 | 27x2xh.360 | 9500 |

Ricambi

Spare parts



| per codice | zampa (singola con rondella e dado) | traversa | vite |
|------------|-------------------------------------|----------|---------|
| 111 006 | 111 026 | 111 047 | 111 067 |
| 111 007 | 111 027 | 111 048 | 111 070 |

Mini estrattore universale a tre zampe a sezione tonda con piede a punta conica sottile

Universal micro puller triple with conical point leg

acciaio cr. v.
zincato

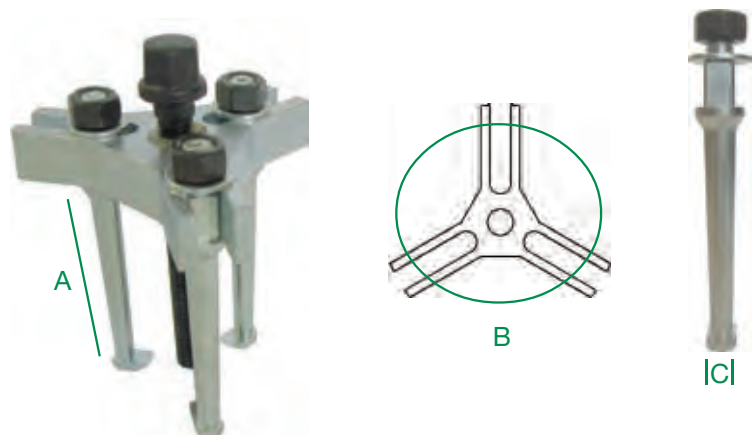

| codice | A | B | C | vite | gr. |
|---------|----|-------|---|--------------|-----|
| 111 010 | 65 | 30-75 | 8 | 10x1.25xh.90 | 400 |

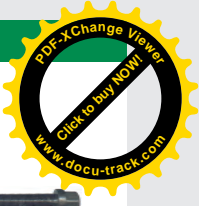
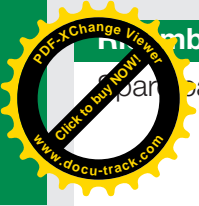

zampa (singola con rondella e dado)
codice 111 021



traversa
111 051 00



vite
codice 111 061

Adattatori opzionali

Optional adaptor

Prolunga per codice 111 010

Prolunga completa di zampa per codice 111 010

acciaio fosfatato

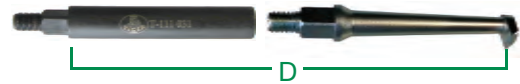
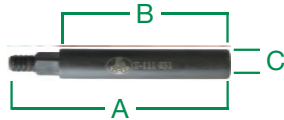

| codice | A | B | C | filetto |
|---------|-----|----|----|---------|
| 111 031 | 105 | 81 | 14 | 8x1.25 |

| codice | composizione | D |
|------------|-------------------|-----|
| 111 031 10 | 111 031 + 111 021 | 145 |

Estrattori universali a 3 zampe nervate con piede a punta sottile

Universal puller with 3 ribbed point legs

acciaio cr. v. zincato



Caratteristica: boccia filettata in acciaio legato ad alta resistenza, grazie a questo particolare le nostre traverse. Praticamente indistruttibili.

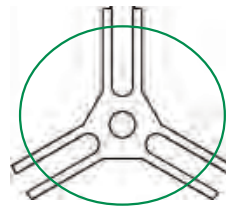
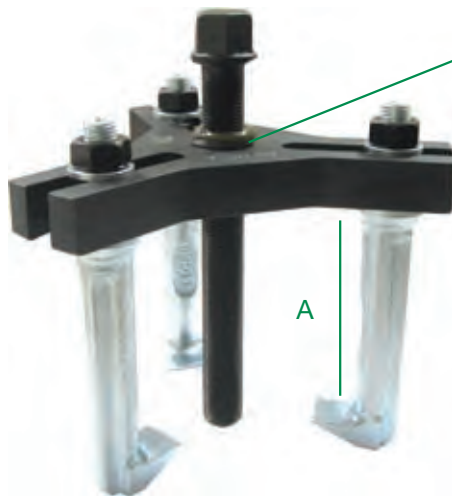

| codice | A | B | C | vite | gr. |
|--|-----|-----|----|------------------|-------|
| 111 011 | 70 | 90 | 15 | 14x1.5xh.105 | 980 |
| 111 012 | 100 | 140 | 21 | 18 x 1.5 x h.160 | 2420 |
| 111 013 | 130 | 180 | 24 | 20 x 1.5 x h.185 | 4370 |
| N.B. le seguenti misure sono con traversa zincata e senza boccole | | | | | |
| 111 015 | 250 | 350 | 24 | 27 x 2 x h.300 | 12600 |
| 111 016 | 290 | 350 | 24 | 27 x 2 x h.390 | 14700 |



| per codice | zampa (singola con rondella e dado) | traversa | vite |
|------------|-------------------------------------|----------|---------|
| 111 011 | 111 022 | 111 051 | 111 063 |
| 111 012 | 111 024 | 111 052 | 111 064 |
| 111 013 | 111 025 | 111 053 | 111 065 |
| 111 015 | 111 026 | 111 055 | 111 069 |
| 111 016 | 111 027 | 111 055 | 111 071 |

Adattatori opzionali

Optional adaptor

acciaio fosfatato



Prolunga

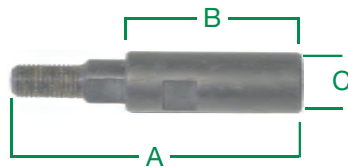

Prolunga completa di zampa

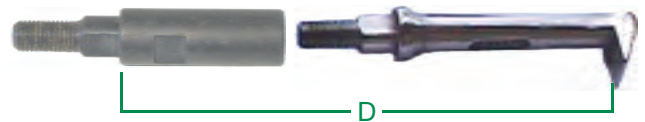

| per codice | codice | A | B | C | filetto |
|------------|------------|-----|-----|----|---------|
| 111 011 | 111 032 | 80 | 50 | 20 | 10x1.5 |
| 111 013 | 111 035 01 | 121 | 71 | 27 | 16x1.5 |
| 111 013 | 111 035 02 | 195 | 146 | 30 | 16x1.5 |

| codice | composizione | D |
|------------|----------------------|-----|
| 111 032 10 | 111 032 + 111 022 | 120 |
| 11103510 | 111 035 01 + 111 025 | 276 |
| 11103511 | 111 035 02 + 111 025 | 276 |

Espositore estrattori a 2 zampe, modello Starker, con piede a punta e zampa forgiata nervata

Exhibitor pullers twin with forged legs

acciaio cr. v.

STARKER



| codice | |
|---------|--------------------------|
| 111 100 | espositore STARKER pz. 6 |

| art. | composizione - composition |
|---------|----------------------------------|
| 111 001 | estrattore 2 zampe mm. 65 x 65 |
| 111 102 | estrattore 2 zampe mm. 70 x 75 |
| 111 103 | estrattore 2 zampe mm. 95 x 130 |
| 111 104 | estrattore 2 zampe mm. 125 x 165 |
| 111 105 | estrattore 2 zampe mm. 150 x 200 |
| 111 106 | estrattore 2 zampe mm. 180 x 240 |

STARKER

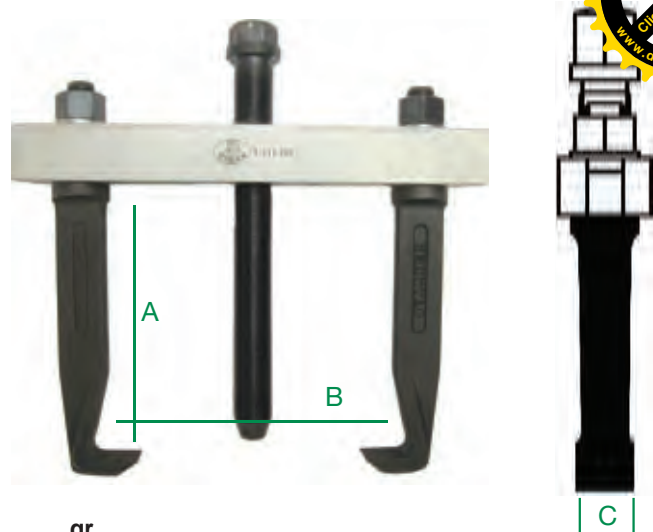

| codice | A | B | C | vite | gr. |
|---------|-----|-----|----|------------------|------|
| 111 102 | 70 | 75 | 14 | 14 x 1.5 x h.110 | 700 |
| 111 103 | 95 | 130 | 19 | 18 x 1.5 x h.160 | 1300 |
| 111 104 | 125 | 165 | 24 | 20 x 1.5 x h.185 | 2000 |
| 111 105 | 150 | 200 | 21 | 22 x 1.5 x h.210 | 2500 |
| 111 106 | 180 | 240 | 27 | 24 x 2 x h.250 | 5600 |

Ricambi

Spare parts



| per codice | zampa (singola con rondella e dado) | traversa | vite |
|------------|-------------------------------------|------------|------------|
| 111 102 | 111 122 | 111 042 | 111 062 |
| 111 103 | 111 123 | 111 044 | 111 063 |
| 111 104 | 111 124 | 111 045 | 111 064 |
| 111 105 | 111 12401 | 111 045 01 | 111 065 01 |
| 111 106 | 111 125 | 111 046 | 111 066 |

Adattatori opzionali

Optional adaptor

acciaio fosfatato

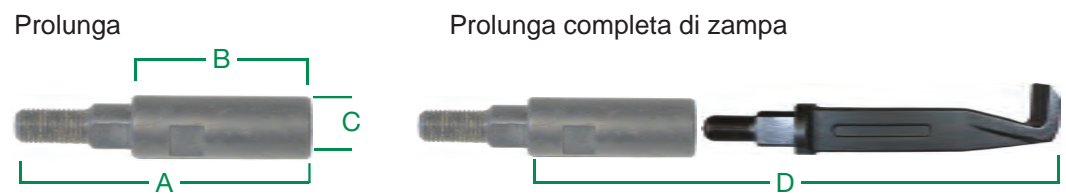

| per codice | codice | A | B | C | filetto | codice | composizione | D |
|------------|------------|-----|-----|----|---------|------------|----------------------|-----|
| 111 102 | 111 032 | 80 | 50 | 20 | 10x1.5 | 111 132 10 | 111 032 + 111 122 | 120 |
| 111 103 | 111 033 01 | 100 | 60 | 20 | 12x1.5 | 111 133 10 | 111 033 01 + 111 123 | 155 |
| 111 103 | 111 033 02 | 140 | 100 | 27 | 12x1.5 | 111 133 11 | 111 033 02 + 111 123 | 195 |
| 111 104 | 111 034 01 | 110 | 70 | 27 | 14x1.5 | 111 134 10 | 111 034 01 + 111 124 | 195 |
| 111 104 | 111 034 02 | 175 | 125 | 30 | 14x1.5 | 111 134 11 | 111 034 02 + 111 124 | 250 |
| 111 105 | 111 035 02 | 200 | 150 | 30 | 16x1.5 | 111 135 11 | 111 034 02 + 111 125 | 280 |
| 111 106 | 111 036 | 220 | 160 | 34 | 18x1.5 | 111 135 10 | 111 036 + 111 125 | 345 |

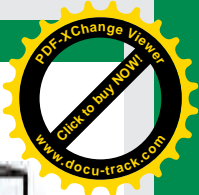
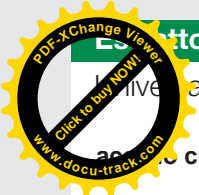

Attori universali con traversa chiusa a 2 zampe forgiate / nervate con piede a punta

Universal puller with closed cross with twin ribbed / forged point legs

360° cr. v.

STARKER

Caratteristica: traversa chiusa, grande resistenza anche sottoposta a grandi sforzi.

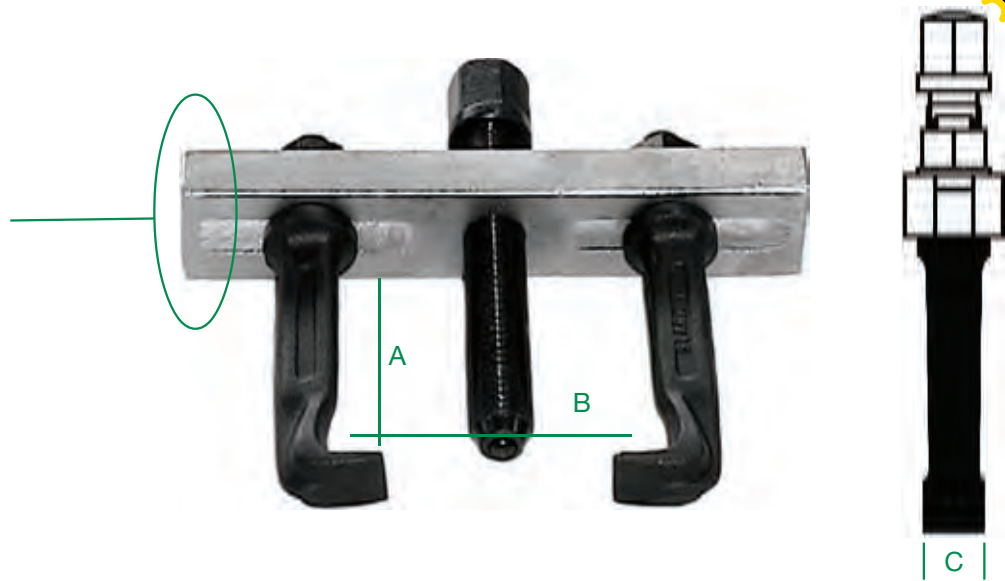

| codice | A | B | C | vite | gr. |
|---------|-----|-----|----|----------------|-------|
| 111 107 | 220 | 350 | 36 | 27 x 2 x h.270 | 9000 |
| 111 108 | 220 | 460 | 36 | 27 x 2 x h.300 | 10500 |
| 111 109 | 220 | 640 | 36 | 32 x 2 x h.340 | 18500 |

Ricambi

Spare parts



| per codice | zampa (singola con rondella e dado) | traversa chiusa | vite |
|------------|-------------------------------------|-----------------|---------|
| 111 107 | 111 126 | 111 049 | 111 068 |
| 111 108 | 111 126 | 111 050 | 111 069 |
| 111 109 | 111 126 | 111 050 01 | 111 072 |

Adattatori opzionali

Optional adaptor

acciaio fosfatato



Prolunga

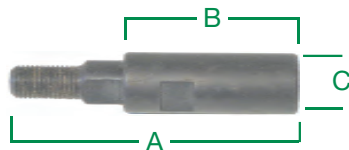

Prolunga completa di zampa

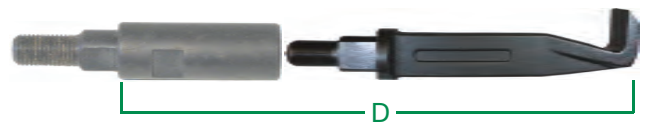

| per codice | codice | A | B | C | filetto |
|------------|---------|-----|-----|----|---------|
| 111 107 | 111 037 | 290 | 220 | 35 | 18x1.5 |
| 111 108 | 111 037 | 290 | 220 | 35 | 18x1.5 |
| 111 109 | 111 037 | 290 | 220 | 35 | 18x1.5 |

| codice | composizione | D |
|------------|-------------------|-----|
| 111 136 10 | 111 037 + 111 126 | 440 |

2000 cr. v.

STARKER

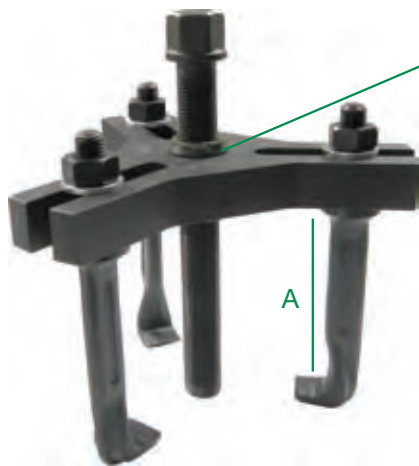
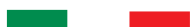

Caratteristica: boccola filettata in acciaio legato ad alta resistenza, grazie a questo particolare le nostre traverse. Praticamente indistruttibili



| codice | A | B | C | vite | gr. |
|-----------|-----|-----|----|------------------|-------|
| 111 111 | 70 | 90 | 15 | 16 x 1.5 x h.100 | 800 |
| 111 112 | 95 | 140 | 19 | 18 x 1.5 x h.160 | 700 |
| 111 113 | 125 | 180 | 24 | 20 x 1.5 x h.185 | 1200 |
| 111 11310 | 150 | 210 | 21 | 22 x 1.5 x h.210 | 2500 |
| 111 114 | 180 | 250 | 27 | 27 x 2 x h.270 | 9000 |
| 111 115 | 220 | 350 | 36 | 27 x 2 x h.270 | 13000 |
| 111 116 | 220 | 520 | 36 | 32 x 2 x h. 300 | 14700 |

Ricambi

Spare parts



| per codice | zampa (singola con rondella e dado) | traversa chiusa | vite |
|------------|-------------------------------------|-----------------|------------|
| 111 111 | 111 122 | 111 051 | 111 063 |
| 111 112 | 111 123 | 111 052 | 111 064 |
| 111 113 | 111 124 | 111 053 | 111 065 |
| 111 113 10 | 111 124 01 | 111 053 01 | 111 065 01 |
| 111 114 | 111 125 | 111 054 | 111 068 |
| 111 115 | 111 126 | 111 055 | 111 068 |
| 111 116 | 111 126 | 111 056 | 111 072 |

Adattatori opzionali

Optional adaptor

acciaio fosfatato



Prolunga

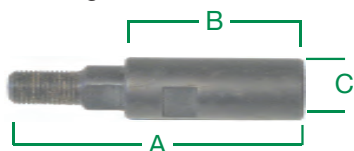

Prolunga completa di zampa

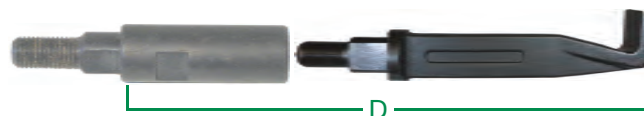

| per codice | codice | A | B | C | filetto | codice | composizione | D |
|---------------|------------|-----|-----|----|----------|------------|----------------------|-----|
| 111 111 | 111 032 | 80 | 50 | 20 | 10x1.5 | 111 132 10 | 111 032 + 111 122 | 120 |
| 111 112 | 111 033 01 | 100 | 60 | 21 | 12x1.5 | 111 133 10 | 111 033 01 + 111 123 | 155 |
| 111 112 | 111 033 02 | 140 | 101 | 27 | 12x1.5 | 111 133 11 | 111 033 02 + 111 123 | 195 |
| 111 113 | 111 034 01 | 111 | 71 | 27 | 14x1.5 | 111 134 10 | 111 034 01 + 111 124 | 195 |
| 111 113 | 111 034 02 | 175 | 125 | 30 | 14x1.5 | 111 134 11 | 111 034 02 + 111 124 | 250 |
| 111 114 | 111 036 | 220 | 160 | 34 | 18 x 1.5 | 111 135 10 | 111 036 + 111 125 | 345 |
| 111 115 & 116 | 111 037 | 290 | 220 | 35 | 18 x 1.5 | 111 136 10 | 111 037 + 111 126 | 440 |

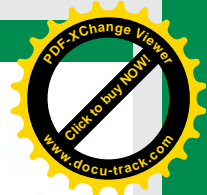
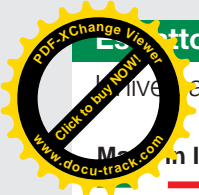

Attori universali a 2 zampe a punta in acciaio forgiato

Universal puller with twin point legs drop forged steel

Made in Italy

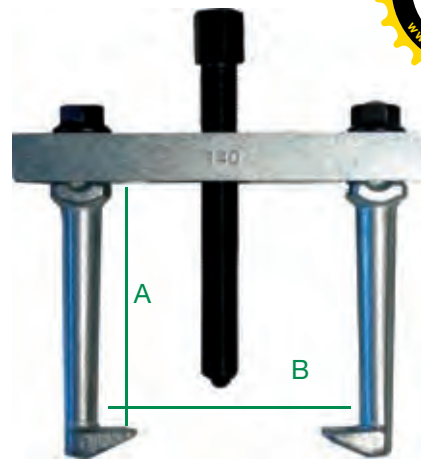

| codice | A | B |
|---------|-----|-----|
| 111 201 | 75 | 60 |
| 111 202 | 75 | 80 |
| 111 203 | 75 | 100 |
| 111 204 | 100 | 120 |
| 111 205 | 100 | 140 |
| 111 206 | 100 | 160 |
| 111 207 | 140 | 180 |
| 111 208 | 140 | 200 |
| 111 209 | 250 | 250 |
| 111 210 | 300 | 300 |

Ricambi

Spare parts



| per codice | zampa | traversa | vite |
|------------|---------|----------|---------|
| 111 201 | 111 221 | 111 241 | 111 261 |
| 111 202 | 111 222 | 111 242 | 111 262 |
| 111 203 | 111 222 | 111 243 | 111 263 |
| 111 204 | 111 223 | 111 244 | 111 264 |
| 111 205 | 111 223 | 111 245 | 111 265 |
| 111 206 | 111 223 | 111 246 | 111 266 |
| 111 207 | 111 224 | 111 247 | 111 267 |
| 111 208 | 111 224 | 111 248 | 111 268 |
| 111 209 | 111 225 | 111 249 | 111 269 |
| 111 210 | 111 226 | 111 250 | 111 270 |

NOTE



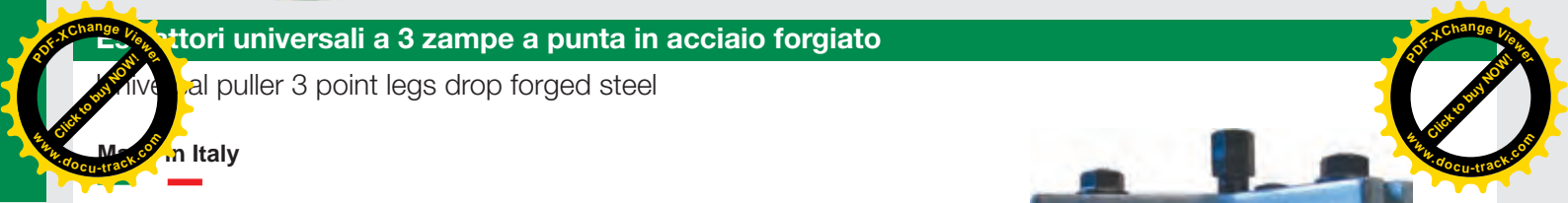

Estrattori universali a 3 zampe a punta in acciaio forgiato

Universal puller 3 point legs drop forged steel

Made in Italy

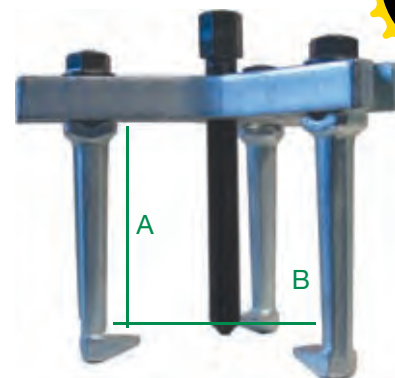

| codice | A | B |
|---------|-----|-----|
| 111 211 | 75 | 90 |
| 111 212 | 100 | 120 |
| 111 213 | 100 | 160 |
| 111 214 | 140 | 180 |
| 111 215 | 250 | 250 |
| 111 216 | 250 | 350 |
| 111 217 | 300 | 350 |

Ricambi

Spare parts



| per codice | zampa | traversa | vite |
|------------|---------|----------|---------|
| 111 211 | 111 222 | 111 251 | 111 271 |
| 111 212 | 111 223 | 111 252 | 111 272 |
| 111 213 | 111 223 | 111 253 | 111 273 |
| 111 214 | 111 224 | 111 254 | 111 274 |
| 111 215 | 111 225 | 111 255 | 111 275 |
| 111 216 | 111 225 | 111 256 | 111 276 |
| 111 217 | 111 226 | 111 257 | 111 277 |

Estrattori universali a 2 zampe a punta in acciaio forgiato

Universal puller 2 point legs drop forged steel

Made in Italy

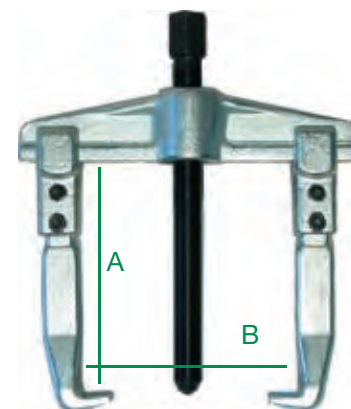

| codice | A | B |
|---------|-----|-----|
| 111 301 | 98 | 80 |
| 111 302 | 98 | 130 |
| 111 303 | 150 | 160 |
| 111 304 | 150 | 200 |
| 111 305 | 200 | 250 |
| 111 306 | 200 | 350 |
| 111 307 | 200 | 520 |

Ricambi

Spare parts

Adattatori opzionali

Optional adaptor



| per codice | zampa | traversa | vite | Zampa prolungata | C |
|-----------------------------|---------|--------------------------------|--------------------------------|------------------|-----|
| 111 301 / 111 302 | 111 321 | 111 341 - 111 342 | 111 351 - 111 352 | 111 331 | 200 |
| 111 303 / 111 304 | 111 322 | 111 343 - 111 344 | 111 353 - 111 354 | 111 332 | 300 |
| 111 305 / 111 306 / 111 307 | 111 323 | 111 345 - 111 346 - 111 347 | 111 355 - 111 356 - 111 357 | 111 333 | 350 |
| 111 305 / 111 306 / 111 307 | 111 323 | 111 345 - 111 346 - 111 347 | 111 355 - 111 356 - 111 357 | 111 334 | 520 |

Estrattore universale a 2 zampe oscillanti e punta a spillo - Vite testa stampata con filetto ru

Universal puller 2 point swinging legs

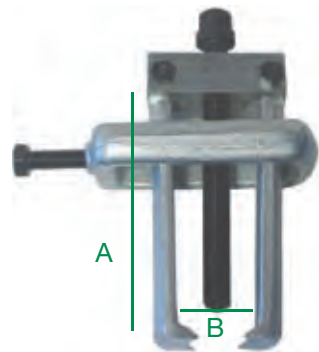

| codice | A | B |
|------------|------------------|----|
| 111 480 01 | Min 13 / Max 140 | 10 |

Ricambi

Spare parts



| Traversa | Zampa | Vite 16 x 1,5 x 165 | Anello completo | Vite extra lunga 16 x 1,5 x 250 |
|-----------|------------|---------------------|-----------------|---------------------------------|
| 111 48201 | 111 483 01 | 111 484 01 | 111 485 01 | 111 486 |

Estrattore universale a 2 zampe con fermo a vite - Zampe forgiate con occhiello per traversa

Universal puller 2 legs

acciaio speciale
cromato

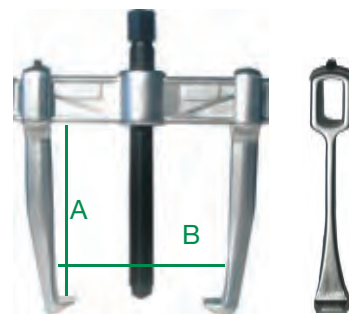

| codice | A | B |
|---------|-----|----------|
| 112 001 | 100 | 15 - 85 |
| 112 002 | 100 | 15 - 125 |
| 112 003 | 150 | 20 - 160 |
| 112 004 | 150 | 20 - 200 |

Set estrattore a 2 zampe, con 3 coppie di zampe di diverse misure: 1 vite standard di mm 140 e 1 vite lunga mm 250

2 legs extractor set. Included 3 pair of legs

acciaio cr. v
cromato brunito

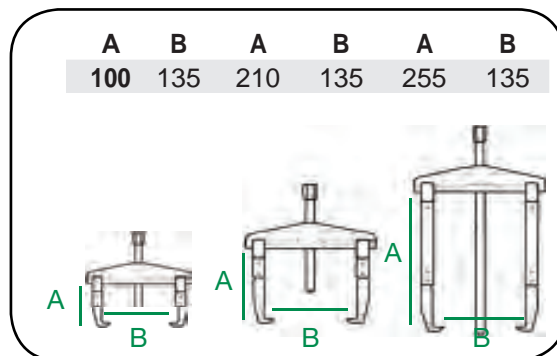

| codice | quantità |
|---------|-------------------|
| 113 110 | Pz 8 in valigetta |

Ricambi - Spare parts

| | |
|------------|---|
| 113 120 05 | vite lunga: \varnothing 14 x 250 |
| 113 120 06 | coppia di ganasce corte per attacco zampe |
| 113 120 07 | coppia di ganasce medie per attacco zampe |
| 113 120 08 | coppia di ganasce lunghe per attacco zampe |
| 113 120 10 | zampa di ricambio con piede spessore mm 3,5 |

Estrattore a 2 & 3 zampe, con tre coppie di zampe di diverse misure: vite standard di mm 140 e una vite lunga

acciaio cr. v
Cromato brunito

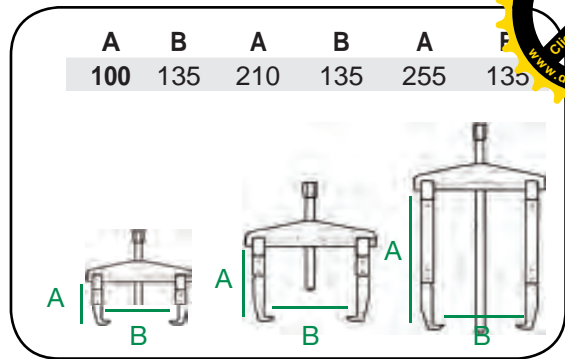
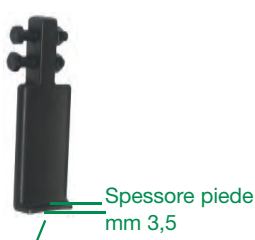

| codice | quantità |
|---------|--------------------|
| 113 120 | Pz 13 in valigetta |

Ricambi - Spare parts

| | |
|------------|---|
| 113 120 05 | Vite lunga: Ø 14 x 250 |
| 113 120 06 | Coppia di ganasce corte per attacco zampe |
| 113 120 07 | Coppia di ganasce medie per attacco zampe |
| 113 120 08 | Coppia di ganasce lunghe per attacco zampe |
| 113 120 10 | Zampa di ricambio con piede spessore mm 3,5 |

Adattatori opzionali per Codici 113 110 & 113 120

Optional adaptor

acciaio cr. v
cromato brunito

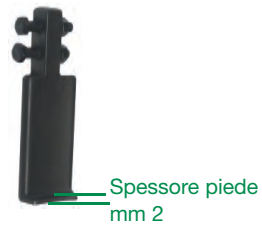

| |
|-------------------------------|
| Zampa con piede spessore mm 2 |
| 113 120 09 |

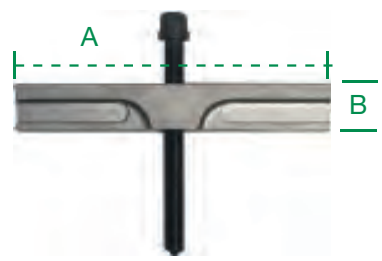

| | | | | | |
|---|---------|-----|----|----|----|
| Traversa con fresatura per attacco zampe estrattori | 113 130 | A | B | C | D |
| | | 235 | 35 | 30 | 20 |



acciaio cr. v
zincato

Estrattore a 3 zampe autoserrante

3 Legs extractor.

acciaio cr. v
zincato

Esterni

Interni

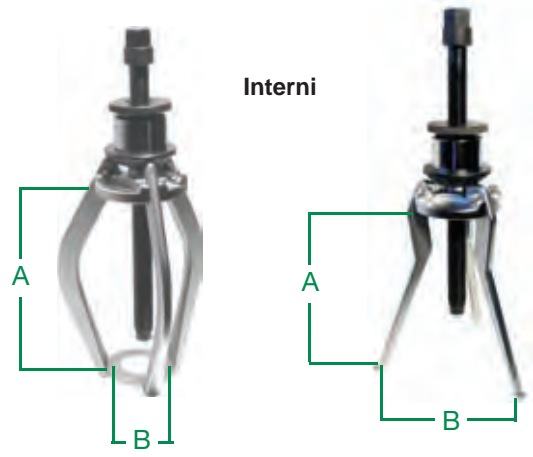

| codice | | A | B |
|---------|---------|-----|------------------|
| 116 001 | esterni | 147 | Min 7 - Max 140 |
| 116 002 | esterni | 200 | Min 10 - Max 180 |
| 116 003 | esterni | 250 | Min 20 - Max 260 |
| 116 006 | interni | 140 | Min 23 - Max 130 |
| 116 007 | interni | 190 | Min 50 - Max 170 |

Ricambi

Spare parts

| per codice | | |
|------------|---------|---------|
| 116 001 | esterni | 116 010 |
| 116 002 | esterni | 116 011 |
| 116 003 | esterni | 116 012 |
| 116 006 | interni | 116 020 |
| 116 007 | interni | 116 021 |

Esterni



Interni



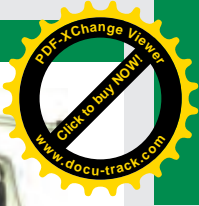
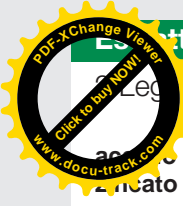

Estrattore a 2 zampe autoserrante

Leg extractor.

acciaio cr. v
cromato

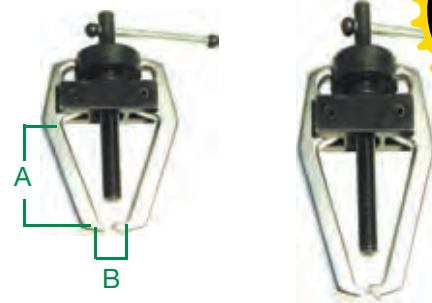

| codice | A | B | |
|---------|----|--------|-----------------------|
| 117 001 | 40 | 0 - 35 | per tergicristalli |
| 117 002 | 60 | 0 - 45 | per morsetti batteria |

Estrattore universale ideale per tergicristalli

Universal wiper arm puller

| codice | A | B |
|---------|----|--------|
| 117 005 | 40 | 0 - 35 |

Dati tecnici - Informative

- di facile impiego, compatto e leggero
- evita le rotture del tergicristallo



Estrattore a 3 zampe sottili, autoserrante, indicato per lavori leggeri

Self - gripping 3 leg puller

acciaio cr. v
cromato

| codice | A | B |
|---------|-----|----------|
| 118 001 | 80 | 17 - 80 |
| 118 002 | 150 | 25 - 150 |
| 118 003 | 200 | 25 - 200 |

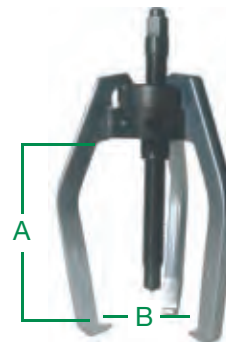

Estrattori universali a 2 zampe autoserranti in Acciaio forgiato

Universal pullers 2 automatic shut legs on drop forged steel

| codice | A | B |
|---------|-----|-----|
| 121 001 | 40 | 55 |
| 121 002 | 65 | 65 |
| 121 003 | 80 | 80 |
| 121 004 | 120 | 120 |
| 121 005 | 160 | 160 |
| 121 006 | 225 | 225 |
| 121 007 | 300 | 300 |
| 121 008 | 425 | 425 |

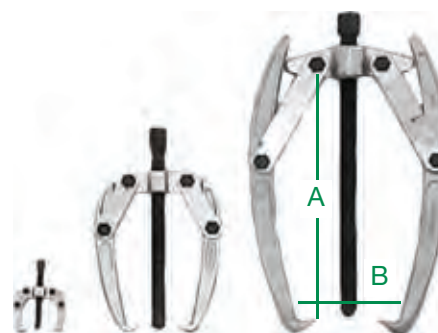

Ricambi

Spare parts

| Per codici | Zampa | Traversa | Vite |
|------------|---------|----------|---------|
| 121 001 | 121 021 | 121 031 | 121 051 |
| 121 002 | 121 022 | 121 032 | 121 052 |
| 121 003 | 121 023 | 121 033 | 121 053 |
| 121 004 | 121 024 | 121 034 | 121 054 |
| 121 005 | 121 025 | 121 035 | 121 055 |
| 121 006 | 121 026 | 121 036 | 121 056 |
| 121 007 | 121 027 | 121 037 | 121 057 |
| 121 008 | 121 028 | 121 038 | 121 058 |

zampa



traversa



vite





Estrattori universali a 3 zampe autoserranti in Acciaio forgiato

Universal pullers 3 automatic shut legs on drop forged steel

| Codice | A | B |
|---------|-----|-----|
| 121 011 | 40 | 55 |
| 121 012 | 65 | 65 |
| 121 013 | 80 | 80 |
| 121 014 | 120 | 120 |
| 121 015 | 160 | 160 |
| 121 016 | 225 | 225 |
| 121 017 | 300 | 300 |
| 121 018 | 425 | 425 |

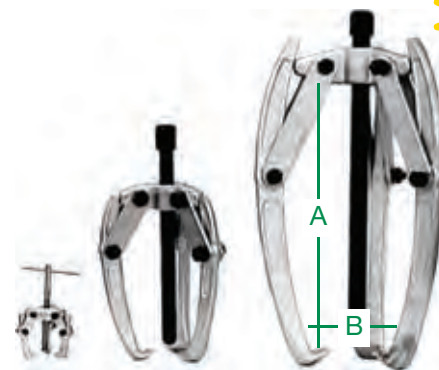

Ricambi

Spare parts

| Per codici | Zampa | Traversa | Vite |
|------------|---------|----------|---------|
| 121 011 | 121 021 | 121 041 | 121 061 |
| 121 012 | 121 021 | 121 042 | 121 062 |
| 121 013 | 121 023 | 121 043 | 121 063 |
| 121 014 | 121 024 | 121 044 | 121 064 |
| 121 015 | 121 025 | 121 045 | 121 065 |
| 121 016 | 121 026 | 121 046 | 121 066 |
| 121 017 | 121 027 | 121 047 | 121 067 |
| 121 018 | 121 028 | 121 048 | 121 068 |

zampa



traversa



vite



Estrattori universali a 2 e 3 zampe reversibili in Acciaio legato

Universal pullers 2 automatic shut legs at double thickness on drop forged steel

acciaio cr. v
cromato

| Codice | | A | B |
|---------|---------|-----|-----|
| 121 101 | 2 zampe | 80 | 150 |
| 121 102 | 2 zampe | 130 | 200 |
| 121 111 | 3 zampe | 80 | 150 |
| 121 112 | 3 zampe | 130 | 200 |

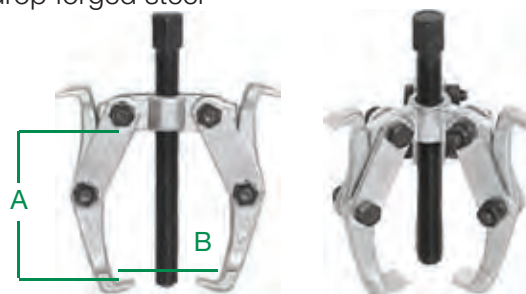

Ricambi

Spare parts

| Per codici | Zampa | Traversa | Vite |
|-------------------|---------|-------------------|-------------------|
| 121 101 e 121 111 | 121 121 | 121 131 - 121 141 | 121 151 - 121 161 |
| 121 102 e 121 112 | 121 122 | 121 132 - 121 142 | 121 152 - 121 162 |

zampa



traversa



vite



Set estrattore a 2 zampe, con 3 coppie di zampe di diverse misure: 1 vite standard di mm 140 e 1 vite lunga mm 250

2 legs extractor set. Included 3 pair of legs

acciaio forgiato

| Codice | A | B |
|---------|-------------------|-------------|
| 121 191 | 180 | 325 |
| Ricambi | | Spare parts |
| Zampa | Traversa con vite | Vite |
| 121 192 | 121 193 | 121 194 |

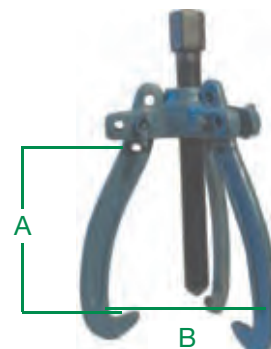

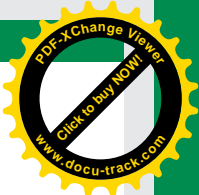
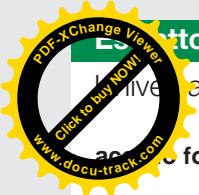

Estrattori universali a 2 zampe autoserranti a doppia sagoma

Universal pullers 2 automatic shut legs double outline on drop

acciaio forgiato

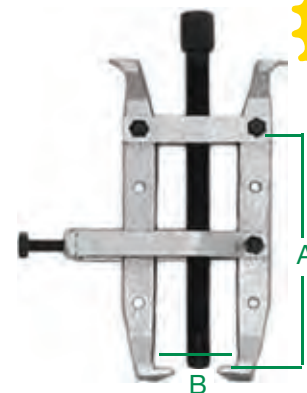

| codice | A | B |
|---------|-----|-----|
| 121 201 | 170 | 95 |
| 121 202 | 270 | 135 |
| 121 203 | 325 | 250 |

Ricambi

Spare parts

| Per codici | Zampa | Traversa | Vite |
|------------|---------|----------|---------|
| 121 201 | 121 221 | 121 231 | 121 251 |
| 121 202 | 121 222 | 121 232 | 121 252 |
| 121 203 | 121 223 | 121 233 | 121 253 |



Estrattore universale a due zampe autoserranti

Universal puller twin automatic shut legs

acciaio speciale
cromato

Spine ad innesto rapido per un veloce cambio di misura

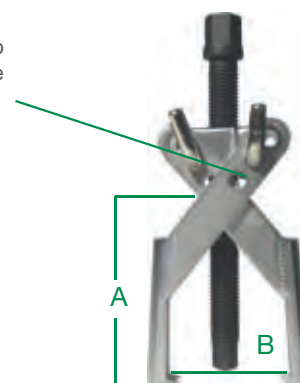

| Codice | A | B | Torsione max (Nm) |
|---------|----------|----------|-------------------|
| 121 361 | 70 - 85 | 6 - 100 | 45 |
| 121 362 | 85 - 120 | 10 - 140 | 65 |

Estrattori universali a 2 zampe

Universal puller 2 legs drop forged steel

acciaio forgiato

| codice | A | B |
|---------|-----|-----|
| 121 401 | 100 | 100 |
| 121 402 | 150 | 150 |
| 121 403 | 220 | 220 |
| 121 404 | 270 | 300 |
| 121 405 | 400 | 350 |

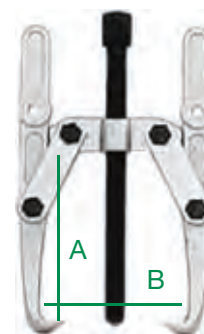

Ricambi

Spare parts

| Per codici | Zampa | Traversa | Vite |
|------------|---------|----------|---------|
| 121 401 | 121 421 | 121 431 | 121 451 |
| 121 402 | 121 422 | 121 432 | 121 452 |
| 121 403 | 121 423 | 121 433 | 121 453 |
| 121 404 | 121 424 | 121 434 | 121 454 |
| 121 405 | 121 425 | 121 435 | 121 455 |



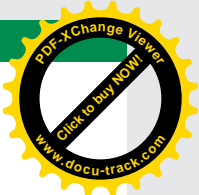
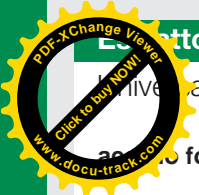

Estrattori universali a 3 zampe

Universal puller 3 legs drop forged steel

acciaio forgiato

| codice | A | B |
|---------|-----|-----|
| 121 411 | 100 | 100 |
| 121 412 | 150 | 150 |
| 121 413 | 220 | 220 |
| 121 414 | 270 | 300 |
| 121 415 | 400 | 350 |

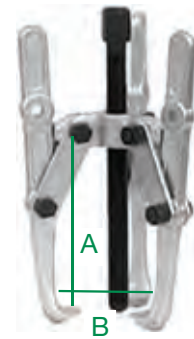

Ricambi Spare parts

| Per codici | Zampa | Traversa | Vite |
|------------|---------|----------|---------|
| 121 411 | 121 421 | 121 441 | 121 461 |
| 121 412 | 121 422 | 121 442 | 121 462 |
| 121 413 | 121 423 | 121 443 | 121 463 |
| 121 414 | 121 424 | 121 444 | 121 464 |
| 121 415 | 121 425 | 121 445 | 121 465 |



Estrattori universali a 3 zampe

Universal puller 3 legs drop forged steel

acciaio forgiato

| codice | A | B |
|---------|-----|-----|
| 131 001 | 50 | 60 |
| 131 002 | 60 | 80 |
| 131 003 | 90 | 120 |
| 131 004 | 110 | 160 |
| 131 005 | 110 | 190 |

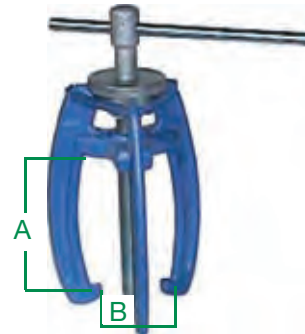

Ricambi Spare parts

| Per codici | Zampa | Traversa con cono | Vite |
|------------|---------|-------------------|---------|
| 131 001 | 131 021 | 131 031 | 131 051 |
| 131 002 | 131 022 | 131 032 | 131 052 |
| 131 003 | 131 023 | 131 033 | 131 053 |
| 131 004 | 131 024 | 131 034 | 131 054 |
| 131 005 | 131 024 | 131 035 | 131 055 |



Estrattori universali a 3 zampe

Universal puller 3 legs drop forged steel

acciaio forgiato

| codice | A | B |
|---------|-----|-----|
| 131 101 | 150 | 250 |
| 131 102 | 190 | 300 |
| 131 103 | 200 | 350 |
| 131 104 | 230 | 425 |
| 131 105 | 250 | 500 |
| 131 106 | 400 | 700 |

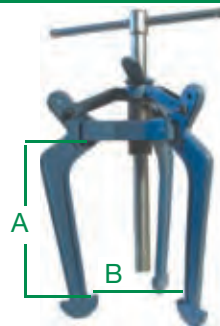

Ricambi Spare parts

| Per codici | Zampa | Traversa completa | Vite |
|------------|---------|-------------------|---------|
| 131 101 | 131 121 | 131 131 | 131 151 |
| 131 102 | 131 122 | 131 132 | 131 152 |
| 131 103 | 131 123 | 131 133 | 131 153 |
| 131 104 | 131 124 | 131 134 | 131 154 |
| 131 105 | 131 125 | 131 135 | 131 155 |
| 131 106 | 131 126 | 131 136 | 131 156 |



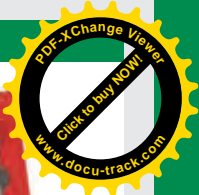
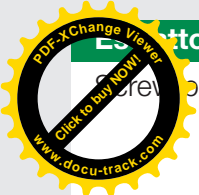

Estrattore a cavallotto per viti

bolts

Codice

135 000 in valigetta M - 4 - 5 - 6 - 8 - 10 - 12



Cassetta pinze ad espansione per estrazioni interne dei cuscinetti

Ball bearing puller set with internal extractor and counter stay devices

codice

141 003 in valigetta pz 9



Composizione - Composition

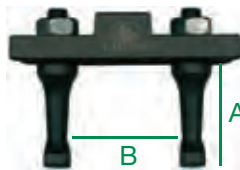

Estrattore

141 005 A B
42 90



| Pinze | Ø | Pinze | Ø |
|---------|-------|---------|-------|
| 141 010 | mm 10 | 141 020 | mm 20 |
| 141 012 | mm 12 | 141 025 | mm 25 |
| 141 015 | mm 15 | 141 027 | mm 27 |
| 141 017 | mm 17 | 141 030 | mm 30 |

Adattatore opzionale

Optional adaptor

Estrattore a percussione con boccia filetto femmina per pinze cuscinetti interni

codice

141 006



mm 380

141 006 10 Boccia con attacco femmina 10 x 1,5

141 006 18 Boccia con attacco maschio 18 x 1,5

141 006 22 Boccia con attacco maschio 22 x 1,5



Kit pinze ad espansione con estrattore a percussione

Ball bearing puller with percussive extractor

codice

141 004 in valigetta pz 10



Composizione - Composition

codice

141 006



mm 380

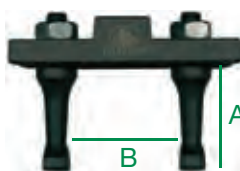

Estrattore

141 005 A B
42 90



| Pinze | Ø | Pinze | Ø |
|---------|-------|---------|-------|
| 141 010 | mm 10 | 141 020 | mm 20 |
| 141 012 | mm 12 | 141 025 | mm 25 |
| 141 015 | mm 15 | 141 027 | mm 27 |
| 141 017 | mm 17 | 141 030 | mm 30 |

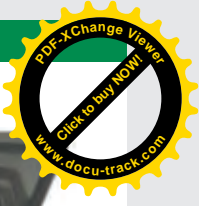
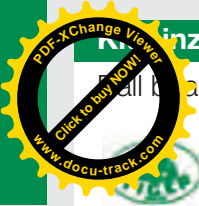

Pinze ad espansione per cuscinetti con due estrattori a percussione 8 x 1.25 e 10 x 1.25

Ball bearing puller with percussive puller 8 x 1.25 - 10 x 1.25

codice
141 101 01 in valigetta pz 11



Composizione - Composition



| Estrattore | L | Pinza | Ø |
|------------|----------------|---------|------------------|
| 141 102 | (8 x 1.25) 395 | 141 110 | (8 x 1.25) mm 10 |
| | | 141 112 | (8 x 1.25) mm 12 |
| | | 141 115 | (8 x 1.25) mm 15 |
| | | 141 117 | (8 x 1.25) mm 17 |
| | | 141 120 | (8 x 1.25) mm 20 |

| Estrattore | L | Pinza | Ø |
|------------|-----------------|---------|-------------------|
| 141 103 | (10 x 1.25) 420 | 141 125 | (10 x 1.25) mm 25 |
| | | 141 127 | (10 x 1.25) mm 27 |
| | | 141 130 | (10 x 1.25) mm 30 |

Kit pinze ad espansione per cuscinetti con estrattore a percussione

Ball bearing puller with percussive puller



codice
141 105 pz 4



Composizione - Composition



| Estrattore | L | Pinza | Ø |
|------------|----------------|---------|------------------|
| 141 102 | (8 x 1.25) 395 | 141 110 | (8 x 1.25) mm 10 |
| | | 141 112 | (8 x 1.25) mm 12 |
| | | 141 115 | (8 x 1.25) mm 15 |

Set battitoi per introduzione dei cuscinetti a percussione oppure con pressa

Set for bearings percussive tipe

Codice
141 140 in valigetta dischi in alluminio pz 10

Ø Interno
35,5 - 39 - 44 - 53 - 58 - 60 - 67 - 71 - 76,5



Set introduzione guarnizioni CORTECO

O-ring remover & installer kit

Codice
141 141 in valigetta



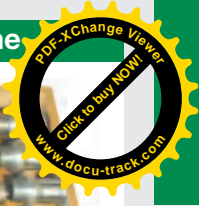
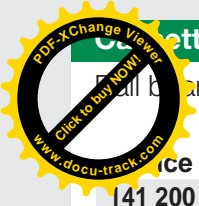

Cassetta pinze ad espansione con estrattore separatore per cuscinetti, completo di prolunghe

Ball bearing puller set with puller and separator



codice
141 200 in valigetta pz 17

Per cuscinetti interni / esterni

Ricambi - Spare parts



Estrattore
141 250



Prolunga
141 253



Prolunga
141 254



Estrattore
141 257



| Pinze | Ø | Pinze | Ø |
|---------|-------|---------|-------|
| 141 212 | mm 12 | 141 225 | mm 25 |
| 141 215 | mm 15 | 141 227 | mm 27 |
| 141 217 | mm 17 | 141 230 | mm 30 |
| 141 220 | mm 20 | 141 233 | mm 33 |
| 141 223 | mm 23 | 141 235 | mm 35 |

Cassetta pinze ad espansione con estrattore a vite

Ball bearing puller set with screw puller

codice
141 205 in valigetta pz 11

Per cuscinetti interni

Ricambi - Spare parts



Estrattore
141 250

| Pinze | Ø | Pinze | Ø |
|---------|-------|---------|-------|
| 141 212 | mm 12 | 141 225 | mm 25 |
| 141 215 | mm 15 | 141 227 | mm 27 |
| 141 217 | mm 17 | 141 230 | mm 30 |
| 141 220 | mm 20 | 141 233 | mm 33 |
| 141 223 | mm 23 | 141 235 | mm 35 |



Valigetta in plastica per pinze ad espansione con estrattore a percussione

Ball bearing puller set with percussion

codice
141 206 in valigetta pz 11

Ricambi - Spare parts



Estrattore a colpo
141 240

| Pinze | Ø | Pinze | Ø |
|---------|-------|---------|-------|
| 141 212 | mm 12 | 141 225 | mm 25 |
| 141 215 | mm 15 | 141 227 | mm 27 |
| 141 217 | mm 17 | 141 230 | mm 30 |
| 141 220 | mm 20 | 141 233 | mm 33 |
| 141 223 | mm 23 | 141 235 | mm 35 |



Estrattore a percussione per cuscinetti utilizzabile con nostre pinze da 141 212 a 141 235

Percussion extractor for bearing

codice
141 240



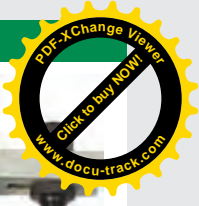
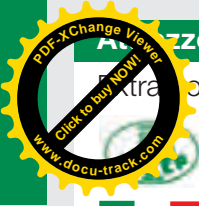

Attrezzo utilizzabile con le pinze ad espansione da 141 212 a 141 235

Attrezzo per bearing

codice

141 250 Atrezzo completo escluso di prolunghe



Ricambi - Spare parts

Adattatori opzionali - Optional

| | | | | | |
|-----------------|----------------|-------------------------|----------------|---------------------|----------------------|
| | | | | | |
| Traversa | Corpo | Tirante c. piede | Piede | Prolunga | Prolunga |
| 141 251 | 141 252 | 141 255 | 141 257 | 141 253 mm40 | 141 254 mm 80 |

Estrattore a 3 zampe rovesciabili per cuscinetti

Extractor to 3 overturnable legs for pad

codice

141 258

Ricambi - Spare parts



Zampa

141 258 01



Interno
mm 19 - 45



Esterno
Max mm 72

Kit pinze ad espansione per estrazione cuscinetti

Ball bearing puller set with percussion puller

codice

141 260

Misure

7-10 / 10-14 / 14-20 / 20-30 / 30-40 in valigetta pz 8

Composizione - Composition



6 Pinze

Da 141 261 - a 141 265



Cavallotto

141 266



Estrattore a percussione

141 267



Pinze ad espansione

Ball bearing puller

Pinze per codice 141 266 & codice 141 267

| | |
|---------|-----------|
| 141 261 | Ø 7 - 10 |
| 141 262 | Ø 10 - 14 |
| 141 263 | Ø 14 - 20 |
| 141 264 | Ø 20 - 30 |
| 141 265 | Ø 30 - 40 |



Pinze per codice 141 266 01

| | |
|------------|---------|
| 141 265 01 | 40 - 50 |
| 141 265 02 | 50 - 60 |
| 141 265 02 | 50 - 60 |



Estrattori a cavallotto per pinze da 141 261 a 141 265 03

Counter stay device

Codice

Per pinze

141 266 141 261 - 141 262 - 141 263 - 141 264 - 141 265

141 266 01 141 265 01 - 141 265 02 - 141 265 03



141 266 01



141 266

Vite con foro interno filettato per pinze da 141 261 a 141 265

Vite con foro interno filettato per pinze da 141 265 01 a 141 265 03



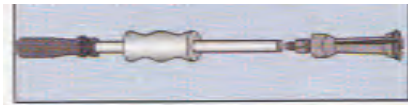

mm 400

Kit pinze ad espansione per estrazione cuscinetti

Ball bearing puller set

codice **Misure**
141 268 7-10 / 10-14 / 14-20 / 20-30 / 30-40 / 40-50 / 50-60 / 60-70 in valigetta pz 10

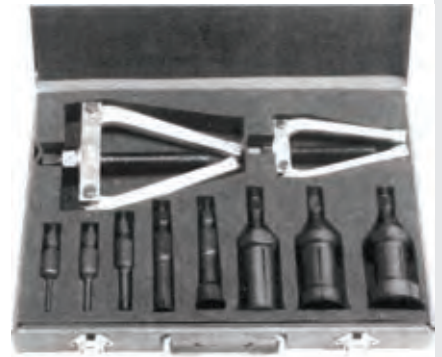

Ricambi - Spare parts

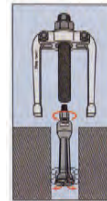

8 Pinze **Estrattore a cavalletto** **Estrattore a cavalletto**
Da 141 261 - a 141 265 03 141 266 141 266 01

Estrattore con 3 prolunghe e separatore per cuscinetti ed ingranaggi

Bearing puller with prolong and separator for ball bearing and gears

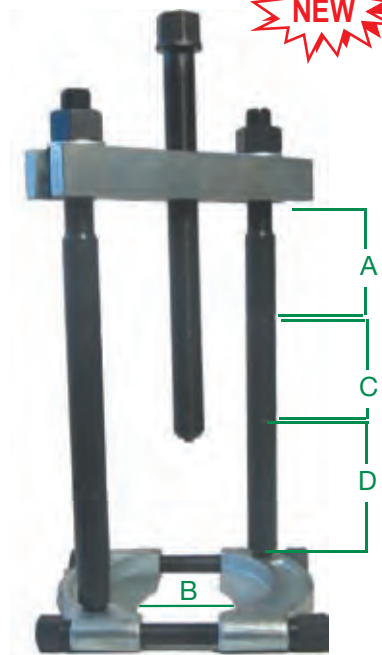

| Codice | A | B | C | D |
|---------|----|-----------|----|----|
| 141 271 | 70 | Ø 20 - 95 | 80 | 60 |

Caratteristica: la particolare fresatura, effettuata con macchine CNC, consente un graduale inserimento delle ganasce. Conseguentemente viene agevolata l'estrazione grazie alla distribuzione sui 360° e su tutti i punti da Ø20 a Ø95, della forza di reazione espressa dalla vite.



Ricambi - Spare parts



| Traversa | Vite centrale 18x1,5x210 | Prolunga 12x1,25 - mm 60 | Prolunga 12x1,25 - mm 80 | Prolunga + attacco per traversa 12x1,25 - mm 70 | Tirante singolo per separatore 12x1,5 - mm 180 | Separatore con tiranti |
|----------|-----------------------------|-----------------------------|-----------------------------|--|---|------------------------|
| 141 044 | 111 064 | 141 253 | 141 254 | 141 255 | 141 275 | 141 273 |

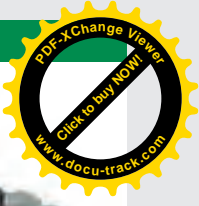
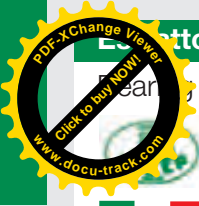

Estrattore con flangia per cuscinetti ed ingranaggi TRUCK

Ball bearing puller with prolong for TRUCK

| Codice | A | B |
|---------|-----|----------|
| 141 281 | 240 | 50 - 200 |

Ricambi - Spare parts

| | | | | |
|-------------------------------|---------------------------------------|-----------------|--------------------------|--------------------------------|
| | | | | |
| Separatore con tiranti | Tirante singolo per separatore | Traversa | Vite con fondello | Tirante laterale mm 240 |
| 141 282 | 141 283 | 111 285 | 141 286 | 141 287 |

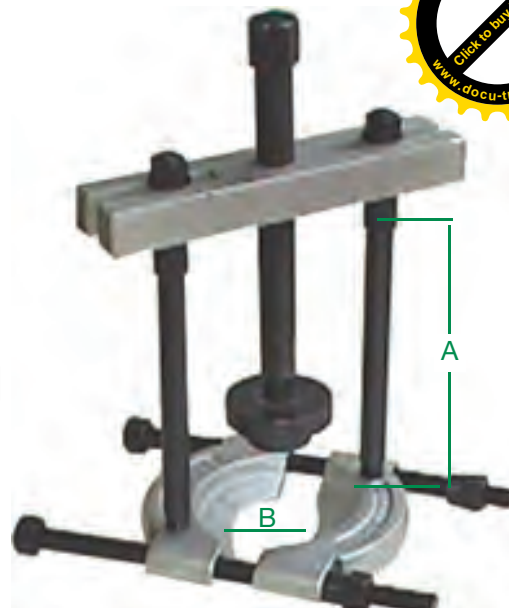

Adattatori opzionali - Optional



Prolunga mm 200
141 288

Estrattore combinato con vite idraulica da 8 Ton

Ball bearing puller with percussion extractor

codice

141 300 in valigetta

Composizione - Composition

- Pz 1 Separatore Ø 20 - 105
- Pz 3 Zampe mm 100
- Pz 3 Zampe mm 150
- Pz 3 Zampe mm 200
- Pz 2 Bulloni mm 180
- Pz 2 Prolunghe mm 230
- Pz 1 Traversa mm 180
- Pz 1 Vite idraulica ton. 8
- Pz 1 Staffa 2 teste per zampe con ghiera
- Pz 1 Staffa 3 teste per zampe con ghiera



Estrattore con tiranti a vite utilizzabili con separatori ingranaggi cuscinetti

For remover bearing with expansion puller

| Codice estrattore | A | utilizzabili con separatori | Ø tiranti C |
|-------------------|-----------|-----------------------------|-------------|
| 141 330 | 50 - 120 | 141 340 | Ø10 x 1.5 |
| 141 331 | 65 - 185 | 141 341 | Ø16 x 2 |
| 141 331 01 | 120 - 300 | 141 342 | Ø20 x 2.5 |

| Codice separatori | B | utilizzabili con separatori | Ø tiranti C |
|-------------------|----------|-----------------------------|-------------|
| 141 340 | 10 - 060 | 141 330 | M10 x 1.5 |
| 141 341 | 20 - 110 | 141 331 | M16 x 2 |
| 141 342 | 30 - 150 | 141 331 01 | M20 x 2.5 |

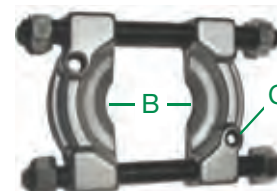
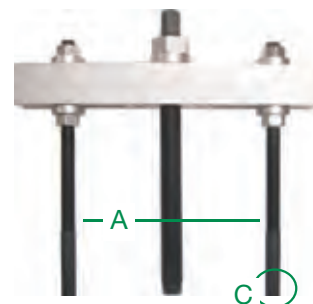

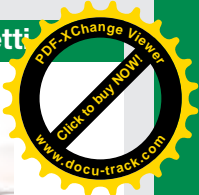
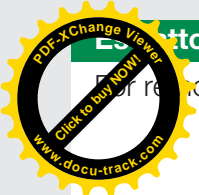

Estrattore con piedi da appoggio e tiranti a vite, utilizzabili con separatori ingranaggi cuscinetti

Bearing puller with expansion puller

| Codice estrattore | A | utilizzabili con separatori | Ø tiranti C |
|-------------------|-----------|-----------------------------|-------------|
| 141 332 | 170 - 400 | 141 343 | Ø22 x 2.5 |
| | | 141 344 | |

| Codice separatori | B | utilizzabili con separatori | Ø tiranti C |
|-------------------|----------|-----------------------------|-------------|
| 141 343 | 20 - 180 | 141 332 | M22 x 2,5 |
| 141 344 | 25 - 250 | 141 332 | M22 x 2,5 |

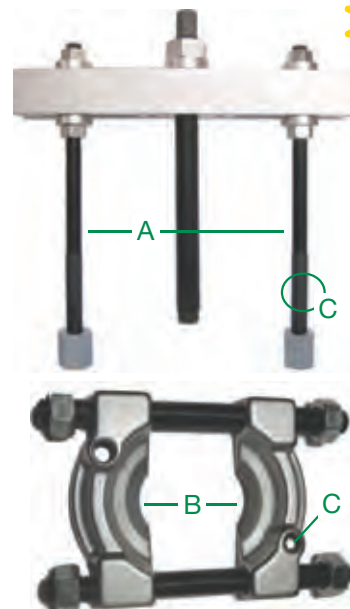

Estrattore con prolunghe e flangia per cuscinetti ed ingranaggi

Bearing puller with prolong

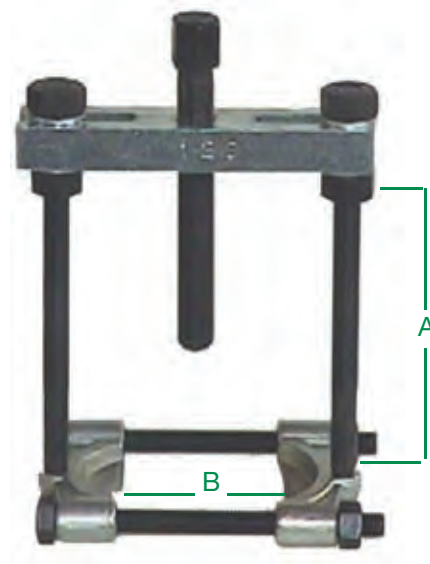

| Codice estrattore | A | B |
|-------------------|-----|----------|
| 141 361 | 150 | 20 - 60 |
| 141 362 | 150 | 25 - 75 |
| 141 363 | 150 | 40 - 115 |

Ricambi - Spare parts



| Per codice | Separatore | Tirante x sep. | Traversa | Vite | Tirante lat. |
|------------|------------|----------------|----------|---------|--------------|
| 141 361 | 141 366 | 141 372 | 141 380 | 141 390 | 141 393 |
| 141 362 | 141 367 | 141 372 | 141 380 | 141 390 | 141 393 |
| 141 363 | 141 368 | 141 373 | 141 381 | 141 391 | 141 394 |



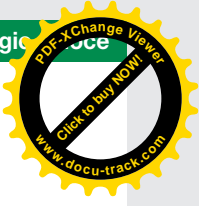
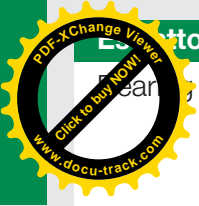

Estratte in valigetta con prolunghe e flangia per cuscinetti e ingranaggi - Vite di pressione per serraggio

puller set with prolonger

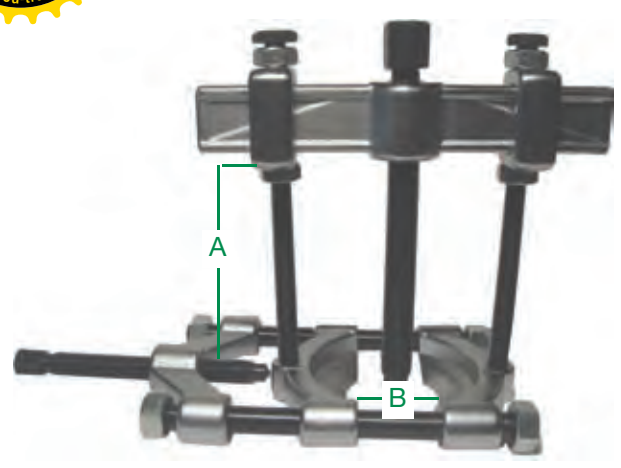

| Codice | A | A con prolunghe | B |
|---------|-----|-----------------|----------------------|
| 141 403 | 100 | 200 | 12 - 75 in valigetta |



Cassetta estrazione cuscinetti a sfera

Kit extraction ball bearing

codice

141 450 in valigetta Pz 44

Composizione - Composition

| | Griffe | Corpi con vite e Asta |
|------|-----------|-----------------------|
| Pz 4 | mm 4x140 | Pz 1 Ø 25 |
| Pz 4 | mm 5x145 | Pz 1 Ø 35 |
| Pz 8 | mm 6x177 | Pz 1 Ø 40 |
| Pz 4 | mm 7x185 | Pz 1 Ø 50 |
| Pz 4 | mm 8x177 | Pz 1 Ø 65 |
| Pz 4 | mm 9x235 | |
| Pz 4 | mm 10x235 | |



Set estrattori cuscinetti con inserimento zampa nella pista sfere previa rottura della gabbia cuscinetto

Micro - Engineering puller kit

codice

Misure

141 460 Per cuscinetti da Ø 25 a 90 - Zampa Ø 5 - 6 - 8 in valigetta pz 10

Ricambi - Spare parts

- 141 46055 Coppia zampe Ø 5
- 141 46060 Coppia zampe Ø 6
- 141 46080 Coppia zampe Ø 8



Flangia per pressa per cuscinetti e ingranaggi

Separator for ball bearing and gears

| Codice | A | B | C | D |
|---------|----|----|----|----|
| 141 500 | 40 | 28 | 40 | 70 |

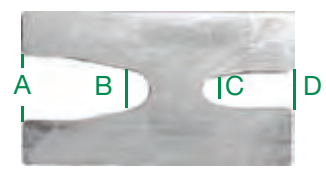

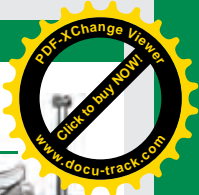
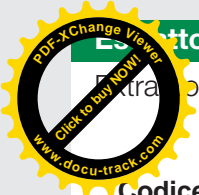

Estrattore a zampe lunghe con capacità da Ø 10 a Ø 50

Extractor for long with with ability from Ø10 to Ø50



| Codice | A |
|---------|-----|
| 142 000 | 300 |

Estrattore perni sferici per tiranti sterzo auto

Ball joint puller of tierods



| codice | A | B | C |
|---------|----|----|----|
| 151 001 | 45 | 42 | 19 |

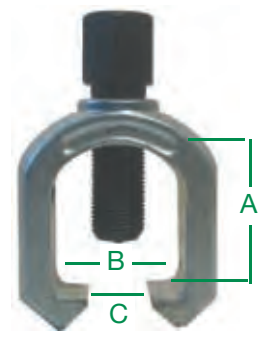

Ricambi - Spare parts



Vite
151 002

Estrattore perni a sfera

Extractor spherical pivots



| codice | A | B | C |
|---------|----|----|----|
| 151 010 | 70 | 70 | 32 |
| 151 012 | 70 | 78 | 38 |

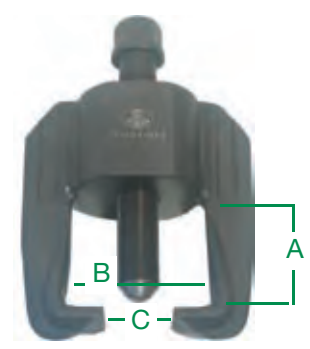

Ricambi - Spare parts

| Per codice | Vite |
|-------------------|---------|
| 151 010 & 151 012 | 151 011 |



Estrattore perni sferici tiranti sterzo auto

Ball joint puller of tierods



| codice | A | B | C |
|---------|----|----|----|
| 151 020 | 39 | 15 | 39 |
| 151 021 | 39 | 18 | 39 |
| 151 024 | 64 | 23 | 40 |



Ricambi - Spare parts

| Per codice | Vite |
|-------------------|---------|
| 151 020 & 151 021 | 151 022 |
| 151 024 | 151 025 |



NOTE





Estrattori per snodi sferici

Ball joint puller set

| codice | A | B | C |
|---------|----|----|----|
| 151 026 | 55 | 23 | 27 |
| | 55 | 28 | 27 |
| | 63 | 34 | 27 |

Dati tecnici - Informative

Utensili per l'estrazione di tiranti sospensioni e perni tiranti sterzo, da bracci di comando, da assali e dallo stabilizzatore. Utilizzo universale per auto e furgoni

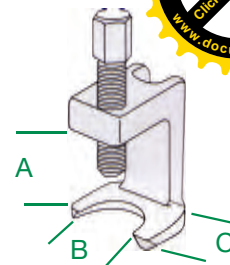

Estrattori perni sferici tiranti sterzo auto

Ball joint puller of tierods

acciaio cr. v
cromato

Audi - Bmw - Opel - Ford - Saab - Volvo

| codice | A | B |
|---------|----|----|
| 151 028 | 56 | 28 |
| 151 029 | 63 | 34 |

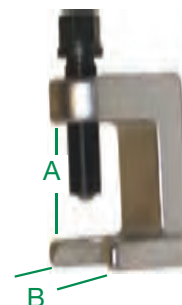

Estrattore perni sferici per Auto & Truck

Truck ball joint separator

| Codice | A | B | C | D | E |
|---------|----|----|-----|-----|----|
| 151 035 | 25 | 60 | 75 | 94 | 56 |
| 151 036 | 30 | 60 | 75 | 94 | 58 |
| 151 037 | 32 | 92 | 122 | 137 | 72 |
| 151 038 | 39 | 60 | 82 | 130 | 80 |

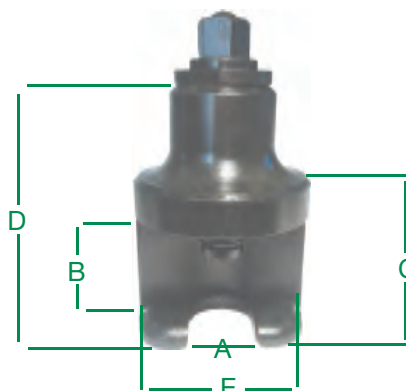

Estrattori perni sferici tiranti sterzo Auto e Autocarro

Ball joint puller of tierods

| Codice | A | B | C |
|---------|----|----|-------------------|
| 151 041 | 35 | 18 | Spessore piede 9 |
| 151 042 | 44 | 24 | Spessore piede 10 |
| 151 043 | 56 | 29 | Spessore piede 11 |
| 151 044 | 80 | 39 | Spessore piede 18 |
| 151 047 | 56 | 29 | Piede sottile 5 |
| 151 048 | 80 | 39 | Piede sottile 11 |

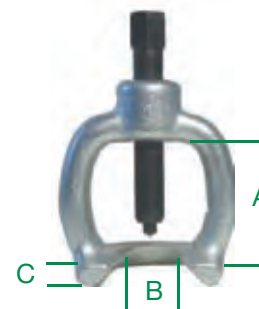

Estrattore perni tiranti sterzo Camion

Extractor pivots connecting rods steering gear for truck

acciaio cr. v
cromato

| codice | A | B | C |
|---------|-----|----|----|
| 151 050 | 100 | 52 | 77 |





Estrattore perni sferici tiranti sterzo auto

Ball joint puller of tierods

| Codice | A | B | C |
|---------|---------|----|----|
| 151 099 | 40 - 60 | 24 | 60 |
| 151 090 | 60 | 24 | 60 |

Ricambi - Spare parts

| Per codice | Vite | Vite laterale |
|------------|---------|---------------|
| 151 069 | | 151 070 |
| 151 090 | 151 091 | 151 092 |

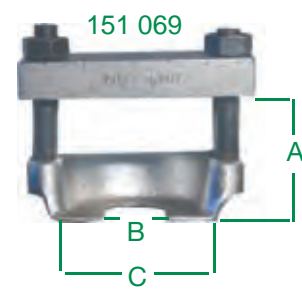

Estrattore perni sferici tiranti sterzo auto

Ball joint puller of tierods



| codice | A | B |
|---------|----|----|
| 151 093 | 48 | 17 |
| 151 094 | 48 | 22 |

Ricambi - Spare parts



Estrattore perni tiranti sterzo auto

Extractor pivots connecting rods steering gear



| codice | A |
|------------|-----|
| 151 096 00 | 145 |
| 151 096 10 | 115 |

Dati tecnici - Informative

Audi A4 - A6 - A8 4WD - VW Passat - Passat syncro - Skoda

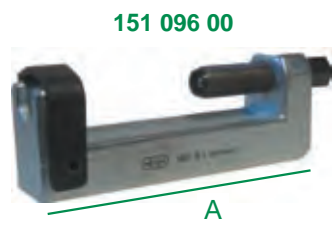

Estrattore perni sferici tiranti sterzo auto

Ball joint puller of tierods



| Codice | A | B |
|---------|---------|---------|
| 151 101 | 30 - 50 | 18 - 22 |

Ricambi - Spare parts



| Vite | Perno Centrale | Spina |
|---------|----------------|---------|
| 151 102 | 151 103 | 151 104 |

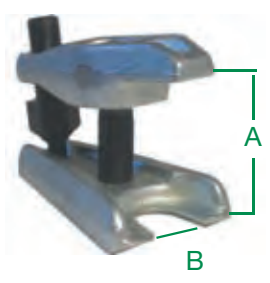

Estrattore perni sferici - Sprinter -

Sprinter ball joint separator



| Codice | A | B | C | D | E |
|---------|----|----|----|-----|----|
| 151 118 | 35 | 60 | 93 | 135 | 90 |

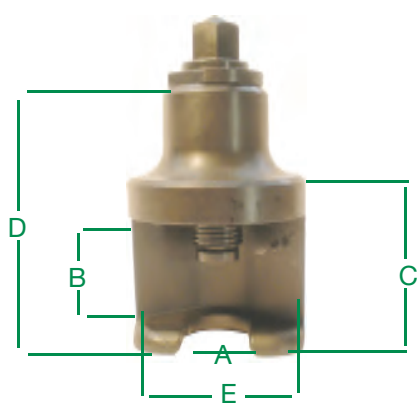

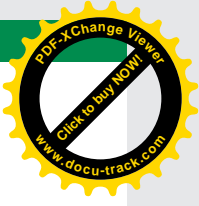
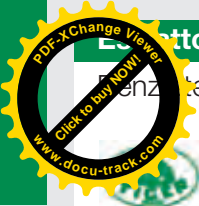

Estrattore / inseritore snodi sferici Mercedes

Steering torque rod joint installer / remover

| Codice | A | B |
|---------|----|----|
| 151 120 | 48 | 34 |



Dati tecnici - Informative

Mercedes W 171 / W 203 / W 209



Estrattore snodi sferici su braccetti Mercedes

Bena drag link puller

| Codice | A | B |
|---------|-----|----|
| 151 122 | 200 | 21 |

Dati tecnici - Informative

Mercedes W 123 - W 124 - W 126 - W 201 - W 202 - W 140



Estrattore snodi sferici su mozzi

Universal ball joint separator

| Codice | A | B |
|---------|----|----|
| 151 124 | 40 | 21 |

Dati tecnici - Informative

Mercedes 201 - 123 - 124 - 126 - 129 etc...

Vw - Audi - Bmw - Citroen - Fiat - Ford - Mitsbischi - Opel - Peugeot - Renault - Saab - Volvo - Japanese car etc..



Estrattore perni sfera tiranti sterzo - Ganascia sottile - Extractor sphere pivots puller of gear

| Codice | A | B |
|---------|---------|------|
| 151 151 | 30 - 40 | 19,5 |

Ricambi - Spare parts



Vite

151 152



Spina

151 153



Estrattore perni sfera a doppia posizione Ball joint puller

| Codice | A | B | C |
|---------|--------|----|-----|
| 151 155 | Max 58 | 21 | 155 |

Ricambi - Spare parts



Vite

151 156



Spina

151 157

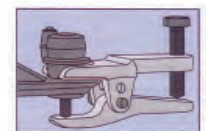
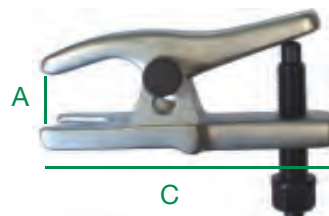

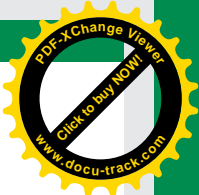
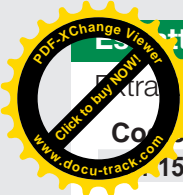

Estrattori perni a sfera con prolunga

Extractor for spherical pivot with prolong

| Codice | A | B | C |
|---------|---------|----|-----|
| 151 158 | 50 - 80 | 22 | 160 |

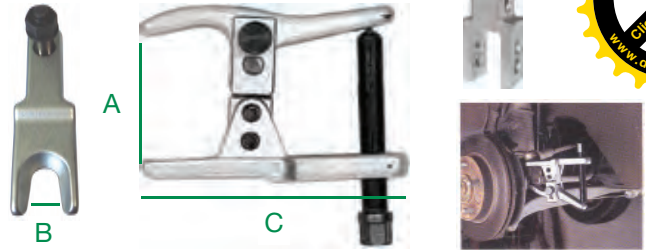

Estrattore perni sfera a ganascia sottile. Il fulcro arretrato agevola l'accesso al perno

| Codice | A | B |
|---------|---------|----|
| 151 159 | 25 - 50 | 21 |



Estrattore perni sfera tiranti sterzo truck - Universal Ball joint extractor

| acciaio cr. v | codice | A | B |
|---------------|---------|-----|----|
| | 151 160 | 160 | 32 |
| | 151 164 | 160 | 45 |

Ricambi - Spare parts

| Per codice | Vite | Perno Centrale | Spina |
|------------|------------|----------------|------------|
| 151 160 | 151 160 01 | 151 160 02 | 151 160 03 |
| 151 164 | Nd | Nd | Nd |

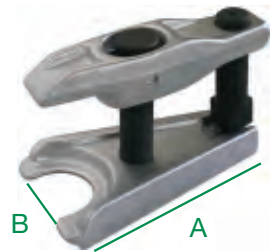

Estrattore universale per perni sfera - Universal extractor spherical pivots

| acciaio cr. v | codice | A | B |
|---------------|---------|-----|----|
| | 151 165 | 190 | 30 |

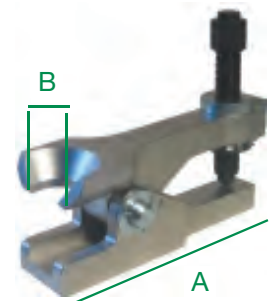

Estrattori perni sferici "Truck" con 5 ganasce intercambiabili - Quick-change ball joint remover

Ball joint puller of tierods

| 151 167 | A | B | C |
|---------|-------|-------|-----|
| | mm 55 | mm 20 | 175 |
| | mm 55 | mm 22 | 175 |
| | mm 55 | mm 24 | 175 |
| | mm 55 | mm 27 | 175 |
| | mm 55 | mm 30 | 175 |

Apertura Max. mm 100
Lunghezza vite di spinta mm 125

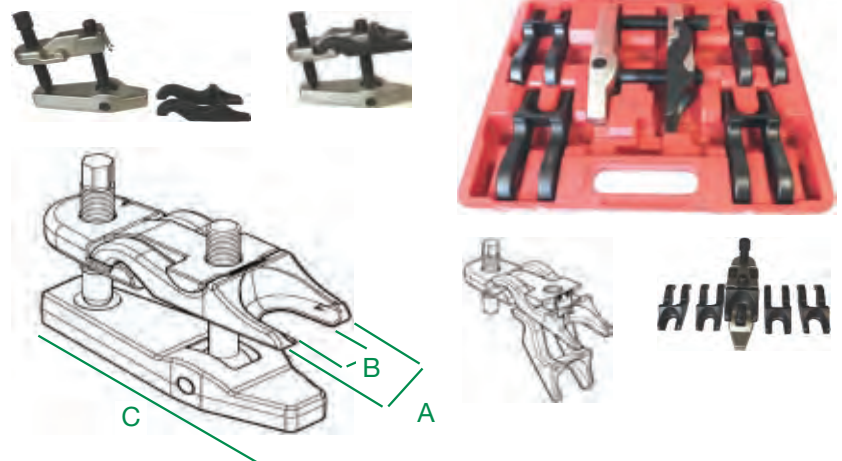

| Codice | A | B | C |
|------------|----|----|-----|
| 151 168 00 | 75 | 35 | 210 |

Ricambi - Spare parts

| Vite | Spina |
|------------|------------|
| 151 168 01 | 151 168 02 |

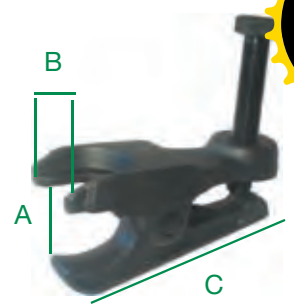

Estattoiri perni sferici TRUCK - Rovesciabile

Extractor pivots connecting rods for truck
acciaio forgiato



| Codice | A | B |
|---------|------------------|----|
| 151 169 | Min 65 - Max 125 | 42 |

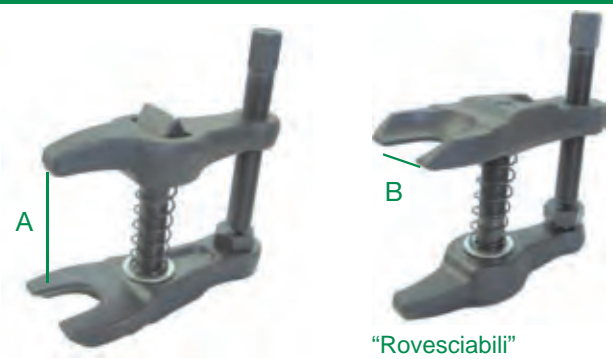

Estrattore perni sferici tiranti sterzo AUTO - Ball joint puller of tierods

| Codice | A | B |
|---------|-----|----|
| 151 170 | 400 | 18 |
| 151 171 | 295 | 24 |

151 170
151 171

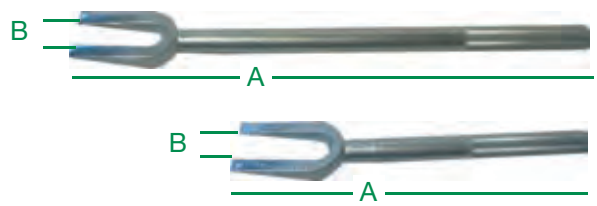

Estrattore perni sferici tiranti sterzo Truck - Ball joint puller of tierods for truck



| codice | A | B |
|---------|-----|----|
| 151 174 | 290 | 27 |
| 151 175 | 290 | 32 |
| 151 176 | 290 | 42 |



Estrattore perni sferici tiranti sterzo

Ball joint puller of tierods

| codice | A | B |
|---------|-----|----|
| 151 182 | 270 | 16 |
| 151 184 | 280 | 20 |

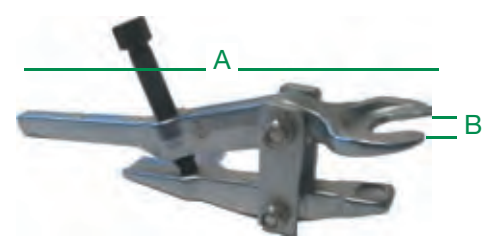

Leva ritegno trapezi durante la lavorazione su sospensioni, semiasse, cambio etc...

Lever for the swinging arm head removal

| codice | A |
|---------|-----|
| 152 000 | 750 |

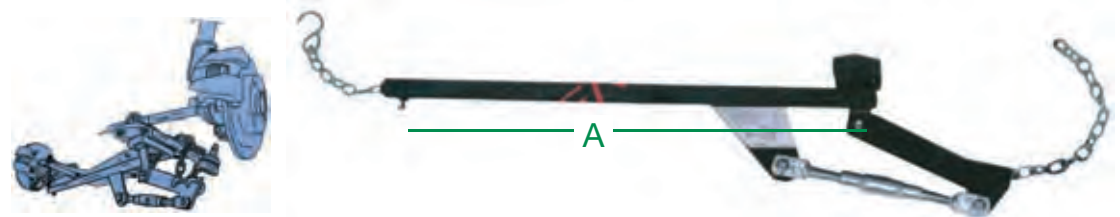

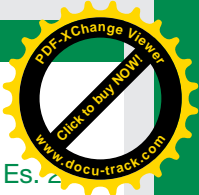
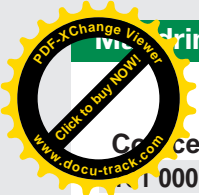

Strutture autoserranti per estrazione prigionieri

| Codice | Ø | Att: | Esagono 1 | Esagono 2 |
|---------|--------|------|-----------|-----------|
| 161 000 | 6 - 12 | 3/8" | 24 | 36 |



Estrattori prigionieri

Stud puller

| Codice | mm | A | Esagono |
|---------|---------|----|---------|
| 161 003 | 16 - 24 | 65 | 34 |
| 161 005 | 5 - 20 | 52 | 22 |

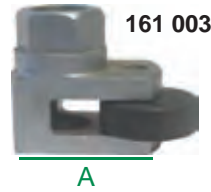

Estrattori prigionieri

Stud puller

| Codice | mm | A |
|---------|---------|-----|
| 161 006 | 2 - 12 | 170 |
| 161 007 | 2 - 18 | 170 |
| 161 008 | 12 - 26 | 170 |

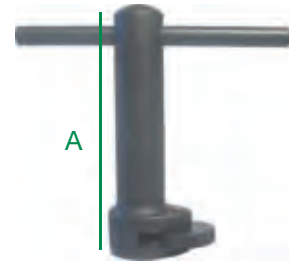

Set estrattori prigionieri a bussola

Stud puller

| Codice | mm | | |
|---------|------------------|--------------|------|
| 161 015 | 6/8/10/12 | in valigetta | pz 4 |
| 161 016 | 5/6/7/8/10/12/14 | in valigetta | pz 7 |



Estrattori prigionieri a bussola - Stud puller

| Codice | Metrici | Codice | POLLICI |
|-----------|------------|------------|---------|
| 161 01805 | mm 5 x 60 | 161 019 06 | 1 / 4" |
| 161 01806 | mm 6 x 60 | 161 019 08 | 5 / 16" |
| 161 01807 | mm 7 x 60 | 161 019 09 | 3 / 8" |
| 161 01808 | mm 8 x 60 | 161 019 11 | 7 / 16" |
| 161 01810 | mm 10 x 68 | 161 019 13 | 1 / 2" |
| 161 01812 | mm 12 x 68 | | |
| 161 01814 | mm 14 x 68 | | |



Set estrattori prigionieri a bussola

Stud puller

| Codice | mm | | |
|---------|------|--------------|------|
| 161 020 | 3/18 | in valigetta | pz 5 |



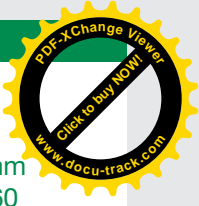
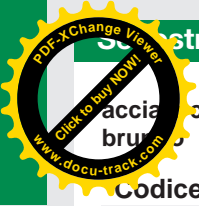

Estrattori per viti spezzate con attacco 3/8"

acciaio cr. mo.

| Codice | Att | A mm | | |
|---------|------|-------------------|------------|------|
| 161 022 | 3/8" | 2 - 3 - 4 - 6 - 8 | Su binario | Pz 5 |



Set estrattori da mm 2 a mm 10 per viti spezzate da mm 5 a mm 20

Set screw broken from mm 2 to mm 10

acciaio cr. mo.
brunito

| Codice | Attacco | A mm | | |
|---------|---------|------------------------|--------------|------|
| 161 023 | 3/8" | 2 - 3 - 4 - 6 - 8 - 10 | In valigetta | Pz 6 |



Kit su binario estrattori viti spezzate - Twist type screw extractor set

acciaio cr. mo.
brunito

| Codice | Attacco | A mm | | |
|---------|---------|------------------|------------|------|
| 161 024 | 1/2" | 8 - 10 - 12 - 14 | Su binario | Pz 4 |



Set estrattori per viti spezzate / Per viti da mm 5 a mm 16

| Codice | | |
|---------|--------------|-------|
| 161 025 | in valigetta | pz 25 |

Composizione - Composition

5 Punte - 10 Guide - 5 Estrattori con guida



Set estrattori per tubi spezzati ad espansione - Internal pipe wrench set

| Codice | | |
|---------|--------------|------|
| 161 030 | in valigetta | pz 6 |

Composizione - Composition

mm 6 - 1/8" / mm 8 - 1/4" / mm 10 - 3/8" / mm 15 - 1/2" / mm 20 - 3/4" / mm 25 - 1"



NOTE

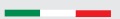

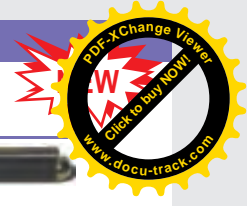
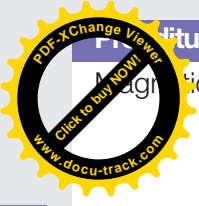

Prenditutto magnetico alta forza per pastiglie valvole

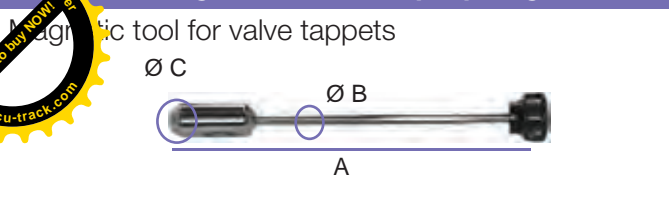

| Codice | A | B | C | Gr. |
|---------|-----|---|----|----------|
| 211 001 | 180 | 5 | 17 | Max 2100 |

Prenditutto magnetico flessibile semirigido

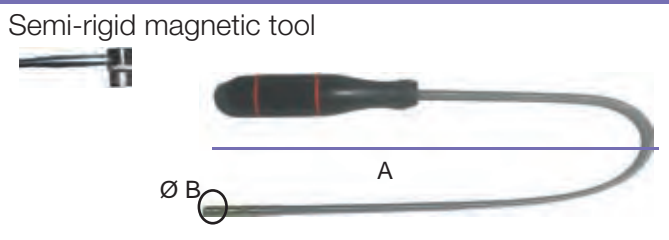

| Codice | A | B | Gr. |
|---------|-----|---|------------------|
| 211 003 | 510 | 6 | Max 550 Max 2100 |

Prenditutto con magnete retrattile per sgancio del pezzo

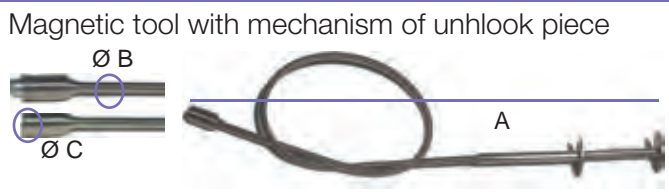

| Codice | A | B | C | Gr. |
|---------|-----|-----|----|---------|
| 211 004 | 600 | 4,5 | 11 | Max 550 |

Prenditutto magnetico flessibile semirigido

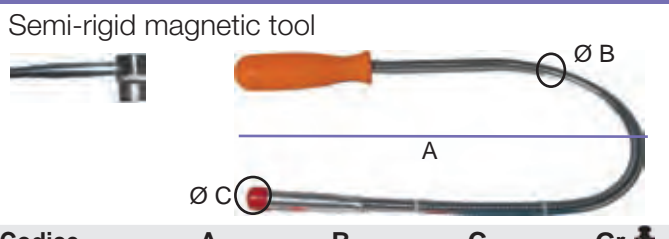

| Codice | A | B | C | Gr. |
|---------|-----|---|----|----------|
| 211 005 | 600 | 7 | 13 | Max 1356 |

Prenditutto magnetico flessibile semirigido

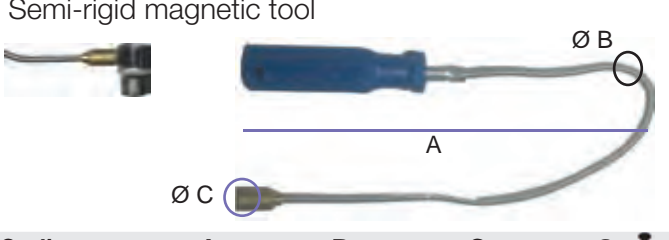

| Codice | A | B | C | Gr. |
|---------|-----|---|----|---------|
| 211 007 | 540 | 6 | 14 | Max 400 |

Prenditutto magnetico telescopico a penna

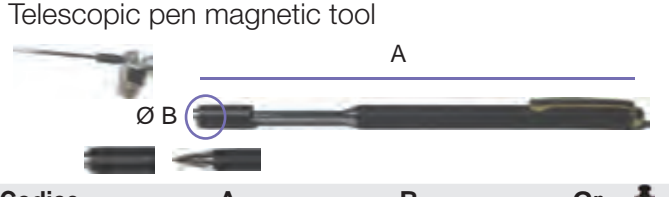

| Codice | A | B | Gr. |
|---------|-----------|---|---------|
| 211 009 | 135 - 630 | 8 | Max 500 |

Prenditutto magnetico telescopico

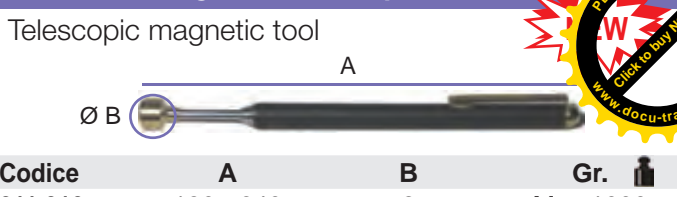

| Codice | A | B | Gr. |
|---------|-----------|---|----------|
| 211 010 | 130 - 640 | 8 | Max 1000 |

Prenditutto magnetico telescopico



| Codice | A | B | Gr. |
|---------|-----------|----|----------|
| 211 011 | 130 - 640 | 11 | Max 1600 |

Lampada magnetica flessibile ricaricabile a manovella

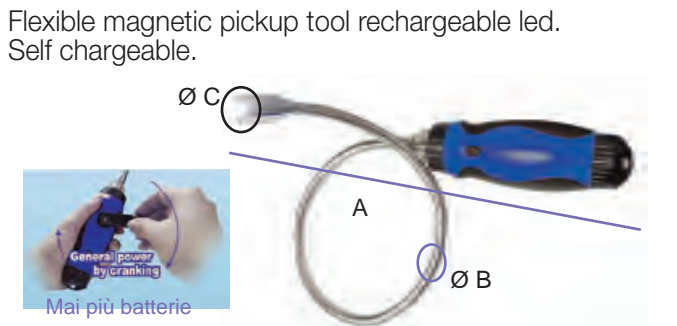

| Codice | A | B | C | Gr. |
|---------|-----|---|----|----------|
| 211 012 | 640 | 9 | 15 | Max 2000 |

Prenditutto flessibile con magnete lampada e griffe



| Codice | A | B | C | Gr. |
|---------|-----|---|----|---------|
| 211 015 | 650 | 7 | 19 | Max 700 |

Prenditutto flessibile con magnete e griffe

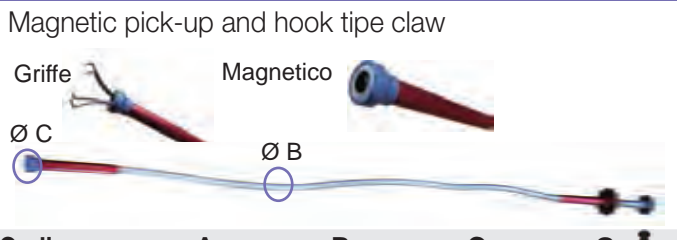

| Codice | A | B | C | Gr. |
|---------|-----|---|----|---------|
| 211 016 | 700 | 9 | 15 | Max 700 |

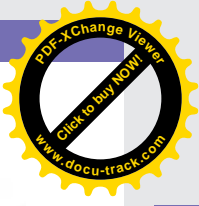
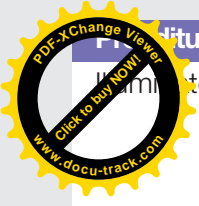

Prenditutto magnetico flessibile semirigido

Magnetic tweezers



211 019 Pz 2 in blister (1 piegata + 1 dritta) mm 170 - Batterie incluse

Prenditutto a molla flessibile a 4 griffe

Plier holder flexible

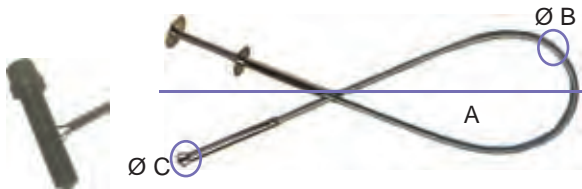

| Codice | A | B | C |
|---------|-----|---|---|
| 211 020 | 620 | 5 | 7 |

Auricolare per auscultare le vibrazioni

Noise tool

Made in U.S.A

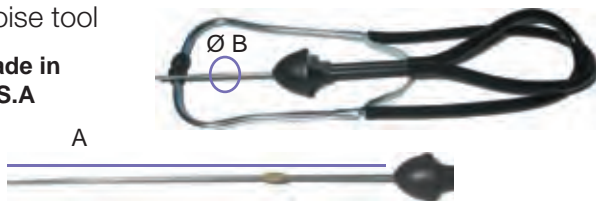

| Codice | A | B |
|---------|-----|-----|
| 211 023 | 300 | 2,8 |

Specchietto telescopico snodato

Inspection mirror telescoping handle

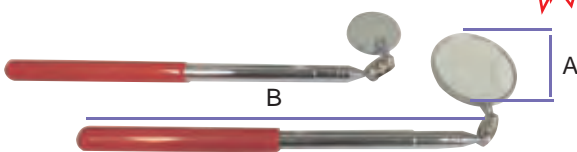

| | A | B |
|---------|-------|----------------------|
| 211 029 | mm 34 | Min 200 - Max 360 mm |
| 211 030 | mm 50 | Min 200 - Max 360 mm |

Specchietto telescopico snodato

Telescoping handle tiil

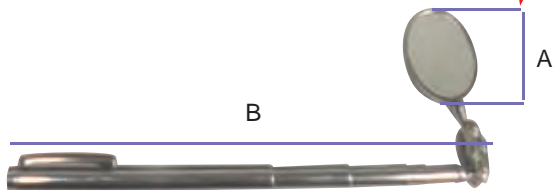

| | A | B |
|---------|---------|------------------------|
| 211 031 | A mm 34 | B Min 120 - Max 470 mm |

Specchietto telescopico

Telescopic mirror

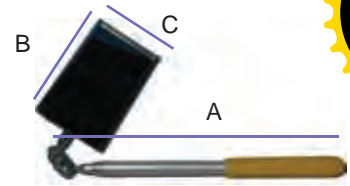

| Codice | A | B | C |
|---------|-----------|----|----|
| 211 032 | 170 - 300 | 90 | 50 |

Specchietto flessibile con luce

Flexible mirror with light

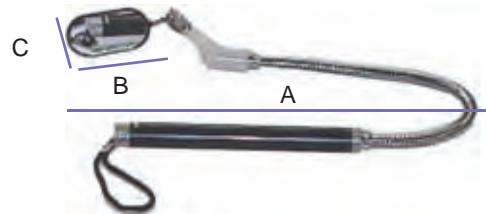

| Codice | A | B | C |
|---------|-----|----|----|
| 211 033 | 450 | 53 | 30 |

Specchietto telescopico

Telescopic mirror

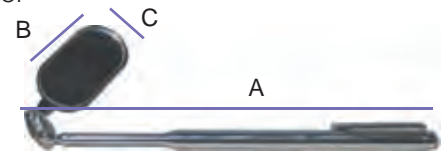

| Codice | A | B | C |
|---------|-----------|----|----|
| 211 034 | 125 - 470 | 50 | 26 |

Kit convertibile telescopico specchio e magnete

Kit convertibile telescopic mirror and magnet

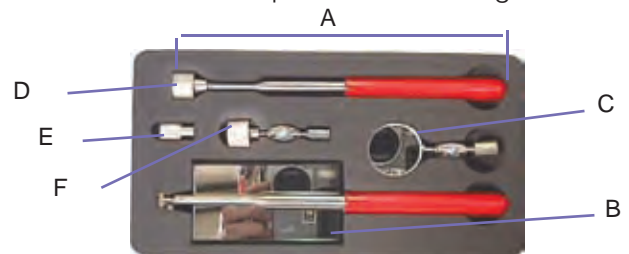

| Codice | A | B | C | D | E | F |
|---------|---------|-------|----|---------|---------|--------|
| 211 035 | 180-260 | 50x90 | 32 | Max2200 | Max3500 | Max500 |

Specchietto ovale flessibile con lampada + magnete

Flexible mirror with lamp lenght



| Codice | A | B | C |
|------------|------------------|----|----|
| 211 036 | 640 | 39 | 24 |
| 211 036 01 | Lampada ricambio | | |

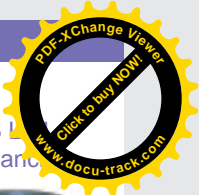
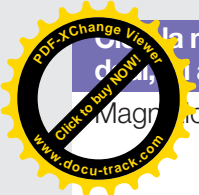

La magnetica per contenimento piccoli utensili, altri particolari in ferro
Magnetic box for holding nuts and other metallic things



211 040 diam. 150 mm

Ciotola magnetica rettangolare mm 235x110

Heavy duty magnetic clamp mm 235x110



211 041

Vaschetta porta-minuterie magnetica

Magnetic tray

Acciaio inossidabile
Lucido



211 042 mm 150 x 130

Dati tecnici - Informativi

- Magnete ricoperto in gomma antigraffio
- Fornito di lunetta contenitrice in modo da poter usare la vaschetta anche in verticale

Comando telescopico per pedaliera Auto / Camion



211 072 cm 150 x 130

Dati tecnici - Informativi

Innovativo attrezzo per agire su: acceleratore, freno, frizione, tramite un singolo operatore, consentendogli di lavorare a propria discrezione in modo sicuro e utile.
 Facile e veloce da montare si può usare anche quando la macchina è sul ponte grazie al suo cavo lungo.
 Ideale per prove di accelerazione, spurgo, controllo stop.

Lente di ingrandimento (3 x) con luci

6 Led lights are bright and clear (3 X)

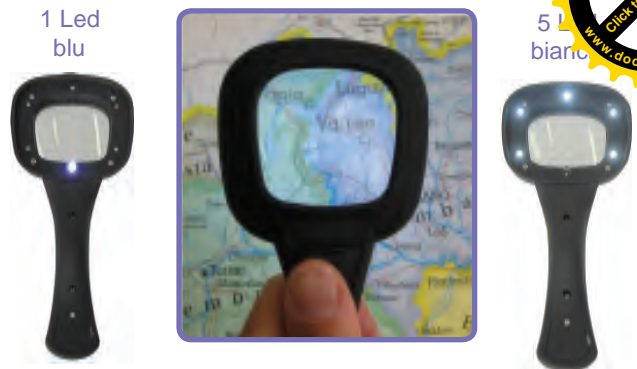

211 100 Lente mm 50 x 50 Batterie incluse

Attrezzo ferma fluidi (5 in 1)

Universal (5 in 1) steel line stopper

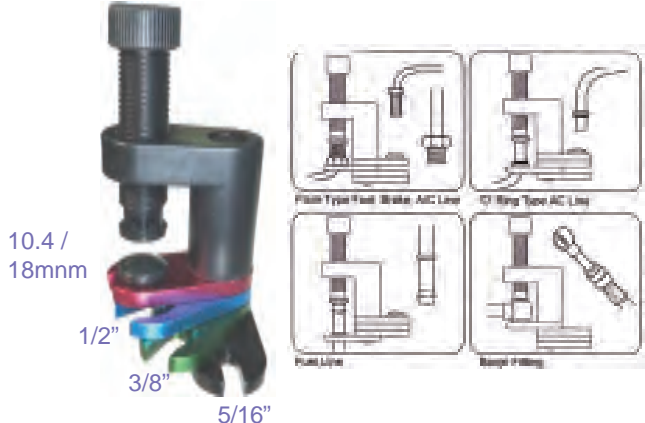

211 995 Range 0 / 55
 Nero 5/16", Verde 3/8", Blu 1/2", Rosso 10.4 & 18mm

Pinza sgancio innesti rapidi carburante e filtro gasolio Fiat Cromia

Fuel line connectors plier

Mercedes, Ford, Mazda, Vw, Audi, Opel, Fiat, Gm, BMW



211 998

Pinza stacca tubi carburante motori Multi-jet

Multijet connection removing plier



211 999

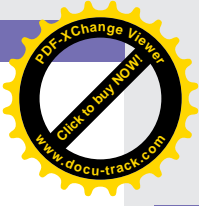
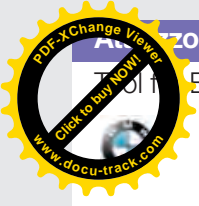

Pinza per stacco tubo carburante Bmw

Bmw fuel line

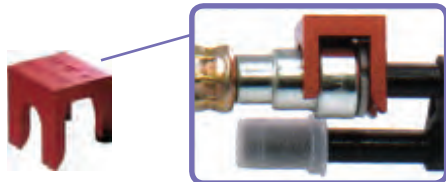

212 000

Pinza per smontaggio tubi benzina

Plier for fuel connections



212 001 8 mm



212 002 10 mm

Pinza per smontaggio tubi benzina su filtro benzina

Plier for fuel connections



212 003 Opel Ford Fiat

Molla smontaggio tubi su filtro benzina in mat. plastico C-M-P

Plier for fuel connections



212 004 Opel Ford Fiat

Pinza sgancio raccordi rapidi tubi carburante

Pliers unhook links rapid pipes fuel



212 005

Pinza per stacco raccordi tubi carburante Multijet

Diesel connection removing pliers

212 007



Set 4 pz. morsetti serraggio tubi carburante



212 008 Per tubi mm 10 - 15 - 25 - 4

Pinza per raccordi rapidi tubi carburante

Fuel feed pipe pliers



mm 160

212 009

Pinza con fermo per serraggio tubazioni

Plier for closing hoses



212 010 8-15 mm

212 011 15-28 mm

212 012 26-65 mm

212 013 Set 3 Pinze - 8-65 mm

Pinza telescopica strozza tubi

Fluid line pinch-off

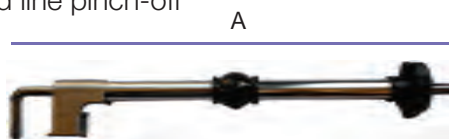

A

B

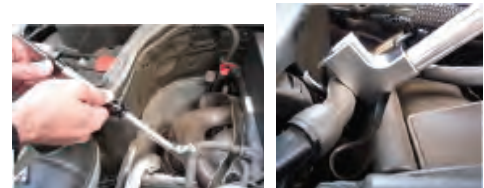

Codice

A

B

212 014

mm 315

Max 28 mm

Pinza con fermo per serraggio tubazioni

Plier for closing hoses



212 015 200 mm

212 016 250 mm

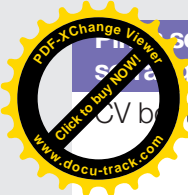

Strumento per serraggio fascette clic di grande potenza,
 il serraggio eseguito mediante vite fissata alle ganasce



212 017

mm 200

Pinza per fascette clic con becchi piegati



212 018 mm 175

Pinza per fascette clic con punte ruotabili in modo da poter utilizzare la pinza frontalmente o lateralmente



212 019 mm 210

Pinza per fascette a scatto click

Click-R collar pliers



212 020

Pinza per fascette "Click" extralunga con testina orientabile

Extra long band plier



A

212 020 10 A mm 360

Fascetta tipo "Click"

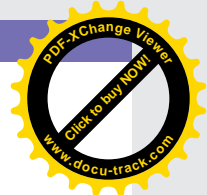

| Codice | Marchio | ØChiusa | Ø Tubo |
|------------|----------|---------|-----------|
| 212 021 | CLIC 80 | 8 | 8.5- 9.5 |
| 212 022 | CLIC 85 | 8.5 | 9-10 |
| 212 023 | CLIC 90 | 9 | 9.5-11 |
| 212 024 | CLIC 95 | 9.5 | 10-11.5 |
| 212 025 | CLIC 100 | 10 | 10.5-12 |
| 212 026 | CLIC 105 | 10.5 | 11-12.5 |
| 212 027 | CLIC 110 | 11 | 11.5-13.5 |
| 212 028 | CLIC 115 | 11.5 | 12-14 |
| 212 029 | CLIC 120 | 12 | 12.5-14.5 |
| 212 030 | CLIC 125 | 12.5 | 13-15 |
| 212 031 | CLIC 130 | 13 | 13.5-15.5 |
| 212 032 | CLIC 135 | 13.5 | 14-16 |
| 212 034 | CLIC 140 | 14 | 14.5-16.5 |
| 212 035 | CLIC 145 | 14.5 | 15-17 |
| 212 036 | CLIC 150 | 15 | 15.5-17.5 |
| 212 037 | CLIC 155 | 15.5 | 16-18 |
| 212 038 | CLIC 160 | 16 | 16.5-18.5 |
| 212 039 | CLIC 170 | 17 | 17.5-19.5 |
| 212 040 | CLIC 175 | 17.5 | 18-20 |
| 212 041 | CLIC 180 | 18 | 18.5-20.5 |
| 212 042 | CLIC 185 | 18.5 | 19-21 |
| 212 043 | CLIC 195 | 19.5 | 20-22 |
| 212 043 01 | CLIC 200 | 20 | - |
| 212 044 | CLIC 205 | 20.5 | 21-23 |
| 212 045 | CLIC 210 | 21 | 21.5-23.5 |
| 212 046 | CLIC 215 | 21.5 | 22-24 |
| 212 047 | CLIC 220 | 22 | 22.5-24.5 |

Kit pinza per fascette Click con 75 fascette

Kit Click plier with 75 bands



212 060 Ø 8 ÷ 15 mm

Pinza fascette click frontale

7" Clic and clic R type clamp pliers



212 061 mm 180



fascette OETICHER-CLICK "R"

Refer. OETICHER-CLICK "R"

Original CAILLEAU



mm 320



212 070 Gr. 670

Kit bussole smonta iniettori e sonda lambda

Kit wrench for removing injectors and lambda sensor



212 099
Att. 1/2"
Pz 14

Composizione - Composition



Chiave poligonale att. 1/2" mm 17 - Renault mm 80



Chiave poligonale att. 1/2" mm 19 - Audi - Mazda - Seat - Vw polo mm 80



Chiave poligonale att. 1/2" mm 21 - Audi - Alfa Romeo - Mitsubishi - Seat - Skoda - Vw mm 85



Chiave poligonale att. 1/2" mm 22 - Audi - Opel - Seat - Skoda - Vw mm 90



Chiave poligonale att. 1/2" mm 22 - Audi - Citroen - Ford - Mazda - Mercedes mm 110



Chiave poligonale att. 1/2" mm 22 - Mercedes mm 150

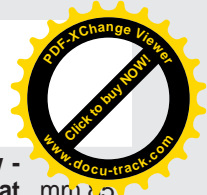

Chiave poligonale att. 1/2" mm 27 - Audi - Bmw - Ford - Mercedes - Nissan - Mitsubishi - Opel - Seat - Lincoln USA mm 100



Chiave poligonale att. 1/2" mm 27 - Citroen - Peugeot - Sistem LVCAS mm 110



Chiave poligonale att. 1/2" mm 28 - Alfa Romeo - Fiat - Opel - Rover mm 80



Chiave poligonale att. 1/2" mm 30 - Mercedes mm 80



Chiave esagonale sonda lambda - Abiertu japan - Att. 1/2" mm 20 mm 80



Chiave esagonale sonda lambda - Abiertu japan - Att. 1/2" mm 27 mm 80



Chiave esagonale sonda lambda - Att. 1/2" mm 22 mm 48



Chiave esagonale sonda lambda - Att. 3/8" mm 22 mm 28

Chiave smontaggio pompa iniezione

Spanner fuel injection pump nut



212 100 Diesel - EP VA-VE e Cav 13 mm

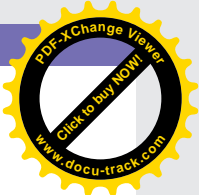
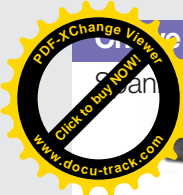

Chiave smontaggio pompa iniezione

Spanner fuel injection pump nut



212 101 127 D-Uno D-Tempra-Tipo D-Punto D-Ritmo - 13 mm

Chiave smontaggio pompa iniezione

Spanner fuel injection pump nut



212 102 Ducato D-127 D-Uno D - Cav - 13 mm

Chiave montaggio iniettori Vag

Key assemblage injectors Vag

Acciaio Cr. M.



212 103 esag. mm - 22x90

Chiave a bussola impact poligonale smontaggio iniettori. Att 1/2"

Poligonal wrench impact removing injectors. Att.1/2"

Acciaio Cr. M.



212 103 01 22x110 - Audi - Citroen - Ford - Mazda - Mercedes - Mitsubishi - Nissan - Seat - Vw - etc..

212 103 02 22 x 150

212 107 01 27 x 110 - Citroen - Peugeot - Sistem LVCAS

212 110 00 21 x 85 - Audi - Alfa romeo - Mitsubishi - Seat - Skoda - Vw

Chiave smontaggio iniettori NISSAN

Key for NISSAN injector

Acciaio Cr. M. Cromata



212 104 Pol. mm 27x80

Chiave smonta iniettori Nissan

Wrench for removing Nissan injector

Acciaio Cr. Vanadio

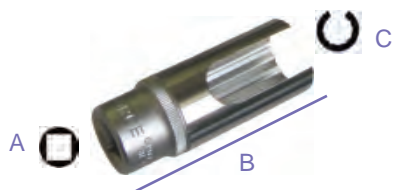

212 104 01 A 1/2" B mm 78 C mm 22

Chiave smontaggio iniettori

Wrench for removing and refitting injectors

Acciaio Cr. M. Cromata

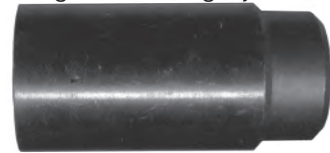

212 105 Universale - Pol. mm 27x80

Chiave smontaggio iniettori

Wrench for removing and refitting injectors

Acciaio Cr. M. Cromata



212 106 Universale - pol. mm 27

Chiave smontaggio iniettori

Wrench for removing and refitting injectors

Acciaio Cr. M. Cromata



212 107 Universale - Pol. mm 27x80

Chiave smontaggio iniettori

Wrench for removing and refitting injectors

Acciaio Cr. M. Cromata



212 108 Polo - Pol. mm 22x80

Chiave smontaggio iniettori

Wrench for removing and refitting injectors

Acciaio Cr. M. Cromata



212 109 Golf TD - Pol. mm 28x80

Chiave smontaggio iniettori lunga

Wrench for removing and refitting injectors

Acciaio Cr. M. Cromata



212 109 01 Pol. mm 28x120

Chiave smontaggio iniettori con doppia fresata

Wrench for removing and refitting injectors

Att. 1/2"

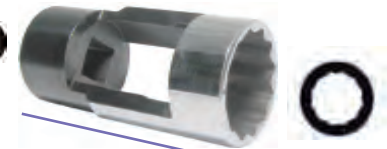

Poligono mm 28

212 109 02 mm 80

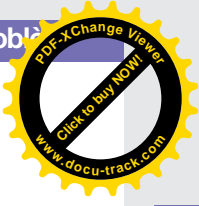
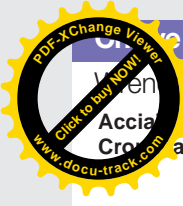

Chiave smontaggio iniettori

Wrench for removing and refitting injectors

Acciaio Cr. M.



212 110 Alfa VM - Mitsubishi TD - Pol. mm 21x80

Chiave smontaggio iniettori trattori

Acciaio Cr. M.
Cromata



212 110 01 Att. 1/2" - Pol. - mm 29x80

Chiave smonta iniettori

Wrench for removing injector

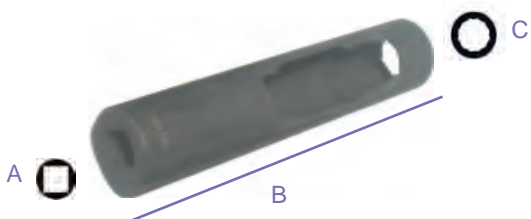

| | A | B | C |
|------------|------|--------|-------|
| 212 110 02 | 1/2" | mm 120 | mm 29 |

Chiave smontaggio precamera iniezione

Wrench for dismantling pre chamber injection

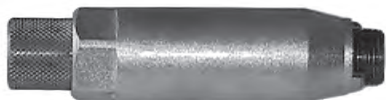

212 111 Mercedes 200 D-190 D-220 D

Chiave smontaggio precamera iniezione

Wrench for dismantling pre chamber injection



212 112 Fiat 127 D- Uno D

Chiave smontaggio precamera iniezione

Wrench for dismantling pre chamber injection



212 113 Bravo D-Brava D-Marea D-Kappa TD-Ulisse

Chiave per ghiera precamera iniettori Fiat Doblò

Wrench for removing and refitting injectors

Acciaio Cr. M.
Brunita



212 114 Att. 1/2" - 4 Denti - Ø 32
Ghiera iniett. FIAT Doblò

Chiave serraggio tubazioni alimentazione su pompe iniezione ad alta pressione

Wrench for removing and refitting injectors tube

Acciaio forgiato
Brunita



212 115 14 3/8" - mm 14

212 115 17 3/8" - mm 17

Chiave serraggio tubazioni alimentazione

3/8", 1/2" injection line socket

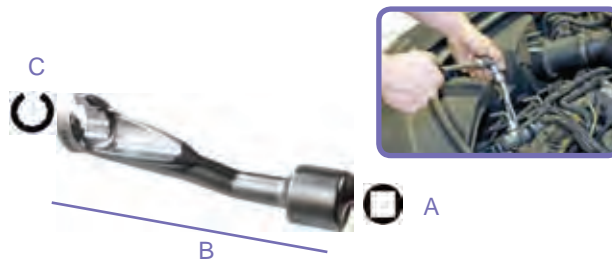

| | A | B | C |
|--|------|-----|----|
| 212 11520 | 3/8" | 115 | 17 |
| *per Bmw e Opel 2.5 TDI | | | |
| 212 115 21 | 1/2" | 119 | 14 |
| *per Bmw e Vw | | | |
| 212 115 22 | 1/2" | 119 | 17 |
| *per Mercedes-Benz: 100, 130, 314, 360h, 352a, 346/355, 401, 402, 403, 407h, 615, 616, 617 | | | |
| 212 115 23 | 1/2" | 119 | 19 |
| *per Mercedes-Benz: M 352, A, 346/355, A, 401/422, LA, 403, 407h, M314 | | | |

Chiave smontaggio pompa iniezione Motori Ford Focus

Acciaio Cr. M.



212 116 T40x75



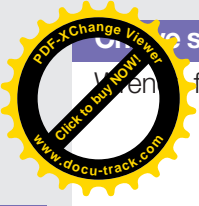

smontaggio precamera iniezione

Wrench for dismantling pre chamber injection



- 212 119 Croma D id-Mecedes 250 TD L. 80 A29 x B22 x C 8
- 212 120 Croma D id-Mecedes 250 TD L. 150 A29 x B22 x C 8

Chiave trilobata per coperchio pompe BOSCH EP/VE

Tool for cover pump "BOSCH" EP/VE



mm 26



212 121 1/2"

Chiave trilobata per supporto leva regolatrice

Tool for level support



mm 13



212 122 1/2"

Chiave dentata smontaggio/montaggio pompe BOSCH PES/M - PES/RSF

Removing and assembling tool for pump BOSCH PES/M - PES/RSF



- 212 123 Ø 19 Mercedes 190D -250D
- 212 123 01 Ø 22 pompe autocarri

Chiave smontaggio precamera iniezione

Wrench for dismantling pre chamber injection



212 124 Mercedes 250 TD

Estrattore smontaggio precamera iniezione

Puller for dismantling pre chamber injection



212 125 Opel D-Mercedes 190/220/300 D - Fil 22x1.5 e 22x1

Estrattore a colpo smontaggio precamera iniezione

Puller for dismantling pre chamber injection



212 126 Mercedes - Boccola 22x1

Estrattore a colpo con testina snodata per smontaggio precamera iniezione

Puller for dismantling pre chamber injection



212 127 Mercedes - Boccola 22x1

Estrattore a colpo per iniettori flangiati Delphi

Acciaio- Brunito



Filetto boccola 14 x 1,5

Filetto boccola 14 x 1,25



360

212 127 10 Completo di 2 boccole

Estrattore a colpo con testina snodata / fissa per smontaggio precamera iniezione macchine movimento terra con boccola F 14 x 1,25

Puller for dismantling pre-chamber injection



A

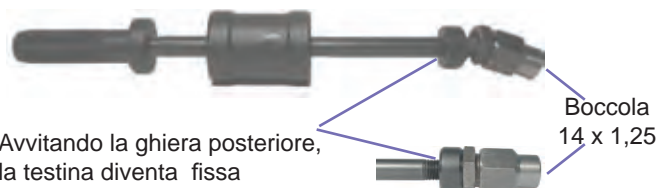

Avvitando la ghiera posteriore, la testina diventa fissa

Boccola 14 x 1,25

212 127 15 A mm 410

Ricambi - Spare parts



212 127 17 Boccola 14 x 1,25

Adattatori opzionali - Optional adaptor



212 127 16 Boccola 12 x 1,50



212 127 18 Boccola 14 x 1,50



212 127 27 Boccola 27 X 1 per elettro-iniettori BOSCH

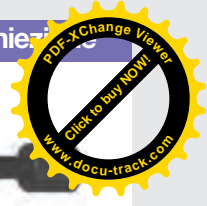

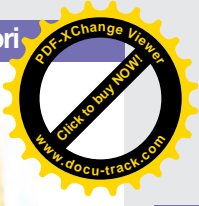
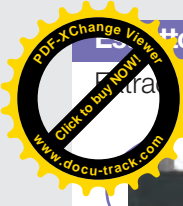

Estrattore a percussione per iniettori-pompa Vw

Extractor for pump injector Vw

Acciaio Cr. V.
Brunito



mm 335

212 127 30

Estrattore a vite con cuscinetto reggi-spinta per iniettori Common rail Bosch montati su Mercedes

Extractor for Mercedes-common rail

Acciaio alta resistenza
Brunito



Reggi spinta



mm 120



212 129 Estrattore completo

Fissare l'estrattore sul filetto interno dell'iniettore dopo aver tolto la parte elettrica ed il grano interno

Ricambi - Spare-parts

212 129 04 Vite tirante mm 120 - Ricambio

Estrattore manuale con cuscinetto reggi-spinta per iniettori Bosch-Common rail

Handle extractor for injector Bosch-common rail

Acciaio alta resistenza
Brunito



A

B

C

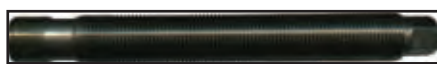

mm 160

212 129 10 Estrattore completo

Utilizzabile con coperchio valvole montato.

Ricambi - Spare-parts

212 129 11 Cilindro A

212 129 12 Cilindro B

212 129 13 Cilindro C

212 129 14 Vite tirante mm 160

212 129 15 Cuscinetto reggi-spinta

Valigetta completa per estrazione elettroiniettori

Kit for removing electro-injector



212 130 Kit completo

Composizione - Composition



mm 700

212 131 01 Asta lunga



212 131 02 Battitoio per asta lunga



212 131 05 Boccola arresto con manopola



mm 280

212 132 01 Asta corta



212 132 02 Battitoio per asta corta

212 131 03
coppia ganasce



212 131 04
guscio

212 131 03 - 212 131 04 kit ganasce prendi iniettore



212 132 03 Boccola 27 x 1



212 132 04 Anello salvafiletto iniettori



212 132 05 Anello arresto battitoio

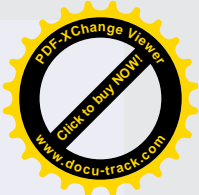
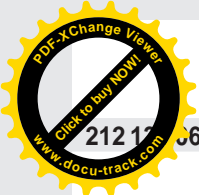

212 1306 Adattatore 14x1.5 iniettore Delphi

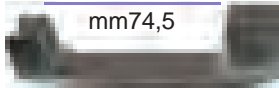

212 133 01 Estrattore a gancio



212 133 02 Battitoio per estrattore a gancio



212 133 03 Asta filettata con dado



212 134 10 Chiave smontaggio interno iniettori mm 10



212 134 29 Chiave smontaggio parte elettrica iniettore mm 29 / 30
212 134 30

Descrizione utilizzo componenti Kit 212 130



212 131 Estrattore con asta lunga:
E' composto da asta 212 13101 da 700mm, massa battente 212 13102 e boccia di fermo con impugnatura 212 13105. Alle estremità ci sono 2 filettature da mm 20 per il fissaggio delle bocce di fermo 21213105 e salva filetto 212 13204, una filettatura da 17 per l'interno iniettori ed un perno di fissaggio coppia semigusci 212 13103.



212 132 Estrattore con asta corta:
E' composto dall'asta 212 13201 con le stesse caratteristiche della precedente ma lunga 280mm e con massa battente 212 13202 di dimensioni più ridotte. L'anello di fermo 212 13205 è cilindrico senza impugnatura.



212 13206 Adattatore 14 x 1,5 iniettore Delphi:
Utilizzabile con 212 131 (asta lunga) e 212 132 (asta corta)

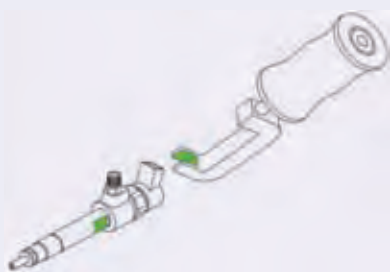

212 133 Estrattore a gancio:
E' composto dal gancio 212 13301, dalla massa battente 212 13302 e dall'asta filettata con dado 212 13303. Viene utilizzato sulle vetture dove lo spazio circostante gli iniettori è abbastanza ampio da poterli andare a prendere sulle fresate del gambo.

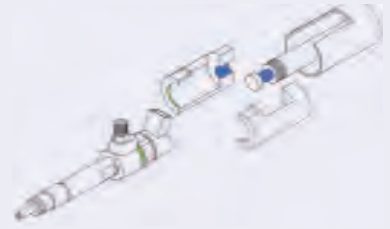

Sistema di aggancio con semigusci:
Come da figura agganciare i semigusci sotto il dado della parte elettrica dell'iniettore e il perno delle aste 212 13101 o 212 13201; calzare il tubo di tenuta 212 13104 sopra i semigusci in modo che non si possano riaprire ed il sistema è pronto per essere utilizzato.



212 13203 Boccia filettata:
da avvitare sul filetto della parte elettrica iniettore. La boccia si può utilizzare sia con l'asta corta che con quella lunga.

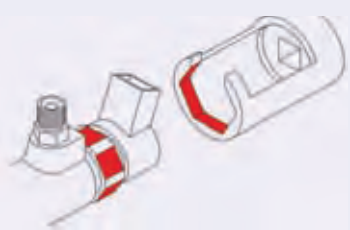

212 13429 / 212 13430 Due chiavi:
di diverse dimensioni con cui andare a smontare la parte elettrica dell'iniettore.



212 13410 / 212 13204 Chiave smontaggio ghiera interna iniettore:
smontato l'interno è possibile inserire la parte filettata degli estrattori lungo e corto in modo da fare una maggiore forza di estrazione. N.B Prima di avvitare l'asta sull'iniettore è bene inserire sull'asta stessa la boccia salva filetto 212 13204 in modo che con il movimento della massa battente non si rischi di andare a sbattere contro il filetto del corpo iniettore rovinandolo.

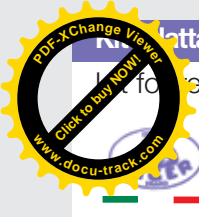

Adattatori a doppia presa per estrazione iniettori

Adattatori per rimuovere electro-injector



- Presa interna tramite il "perno" maschio 17 x 1
- Presa esterna tramite la "boccola" femmina 27 x 1

212 130 04 In blister Pz. 4

Composizione - Composition

- 212 130 05 Perno maschio 17 x 1 da avvitare alla parte interma dell'iniettore
- 212 130 06 Anello compensatore per filetti iniettori bassi
- 212 130 07 Boccola femmina 27 x 1 da avvitare alla parte esterna dell'iniettore
- 212 130 08 Adattatore da applicare al nostro estrattore a percussione ("212 131" Optional)

Adattatore opzionale - Optional adaptor



212 131 Estrattore a percussione con asta lunga (mm 700) e attacco filetto maschio 20 x 1,5

Utilizzo - Utilization

Esempio iniettore con filetto esterno basso

Esempio iniettore con filetto esterno classico



1) Dopo aver smontato la bobina e la ghiera interna, introdurre il perno maschio 17 x 1



2) Nel caso di iniettore con filetto esterno basso infilare l'anello compensatore



3) Avvitare la boccola femmina 27 x 1 alla parte esterna dell'iniettore



4) Avvitare l'adattatore e applicare l'estrattore a percussione



5) Avvitare l'estrattore a colpo (212 131) all'adattatore e procedere tramite percussione



Made in Italy

Estrattore iniettori common rail a colpo, utilizzato direttamente sul mezzo

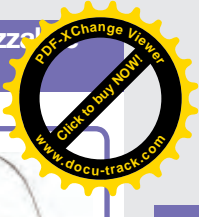

212 130 10

- Montare l'attrezzo sull'iniettore tramite gli idonei adattatori
- Vengono forniti di serie 4 adattatori: due dei quali permettono il fissaggio senza smontare la bobina elettrica dell'iniettore
- Con gli altri due adattatori è necessario smontare la bobina. Per questa operazione, se non ne siete già in possesso, sono necessarie le nostre chiavi: 212 13411 + 212 13429 / 212 13430 (Vedi aggiornamento 2011 pag: 676 - 679)
- Fissare la maniglia di azionamento ad una vite qualsiasi presente nel vano motore; tirando la maniglia si azionerà la massa che estrarrà l'iniettore dalla sua sede

Uso con adattatori per l'utilizzo senza smontare la bobina

Uso con adattatori per l'utilizzo con la bobina smontata

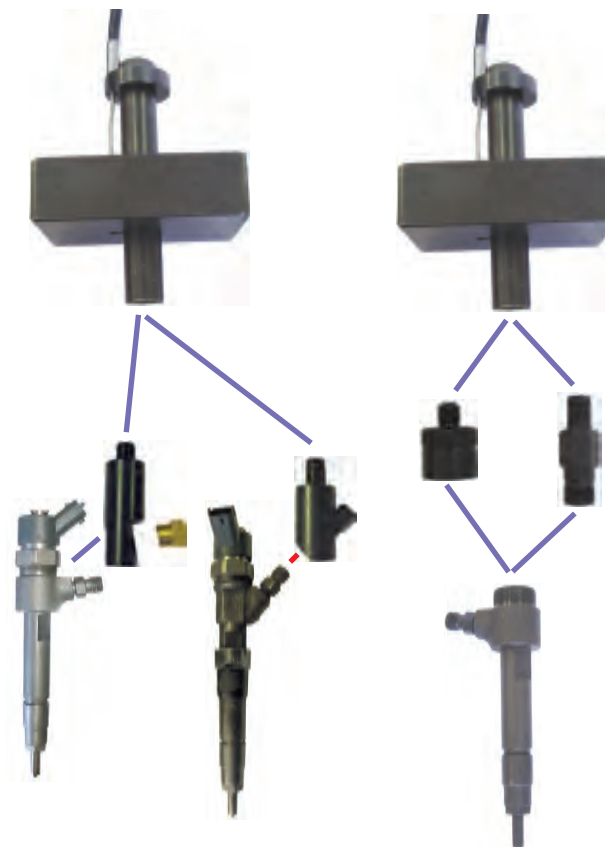

NOTE



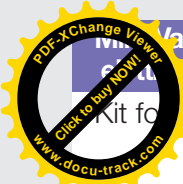

Valigetta di metallo contenente kit per estrazione

iniettori

Kit for removing electro-injector



212 131 55
Adattatore 12x1.5



212 131 50 Kit completo

Ricambi - Spare-parts



212 131 51 Massa battente



mm 300

212 131 52 Asta filettata



212 131 53 Adattatore 14x1.5



212 131 54 Adattatore 14x1.25



212 131 55 Adattatore 12x1.5



212 132 03 Boccola 27x1



212 132 04 Anello arresto battente



212 133 01 Gancio prendi iniettore

Descrizione utilizzo componenti Kit 212 130



Estrattore con gancio.

E' composto dal gancio 212 13301, dalla massa battente 212 13151, dall'asta filettata 212 13152 dall'anello di arresto 212 13204. Viene utilizzata sulle vetture dove lo spazio circostante gli iniettori è abbastanza ampio da poterli andare a prendere sulla parte fresata del corpo iniettore.

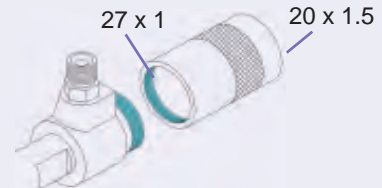

Estrazione con boccola 27x1

Boccola filettata da avvitare sul filetto della parte elettrica dell'iniettore. La boccola viene applicata all'asta tramite il filetto 20x1.5.



Estrazione con boccole = 12x1.5-14x1.25-14x1.5

Avvitare l'adattatore giusto sul filetto iniettore; applicare l'asta tramite il filetto da mm14 della stessa ed inserire la massa battente 212 13151 con l'anello di arresto 212 13204. Per iniettori Delphi e Perkins - Mercedes classe A.

Adattatore estrazione elettroiniettori con boccola filettata 14 x 1.25

Adaptor for removing electro-injector used with our item 212 130



212 132 07



Adattatore utilizzabile con gli estrattore a colpo 212 131 e 212 132" contenuti nel nostro kit 212 130

NOTE



Blank lines for notes

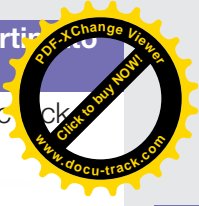
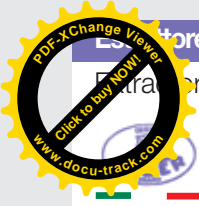

212 133 Gancio per estrattore per Bosch iniettori

Hook for extraction Bosch injector

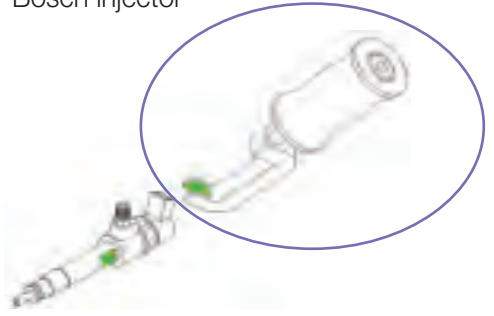

212 133

Ricambi - Spare-parts

- 212 133 01 Gancio
- 212 133 02 Massa battente
- 212 133 03 Asta filettata

Gancio per estrazione iniettori Bosch da utilizzare con estrattore a percussione

Hook for extraction Bosch injector

Acciaio Cr. V.
Zincato

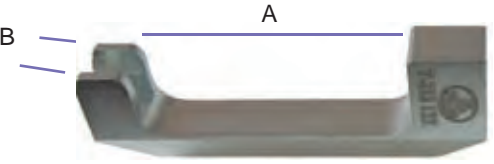

| Codice | A | B |
|------------|---------|---------|
| 212 133 01 | mm 74,5 | mm 12,3 |
| 212 133 05 | mm 89,8 | mm 13,4 |

Chiave smontaggio elettroiniettori

Electro injector remover socket



| | A | B | C | Att. |
|------------|----------|------------|-------------|------|
| 212 134 10 | Foro Ø 6 | Esag. mm10 | Esag. mm 17 | ---- |
| 212 134 11 | Foro Ø 7 | Esag. mm10 | Esag. mm 22 | 1/2" |

Estrattore iniettori Mercedes con vite idraulica

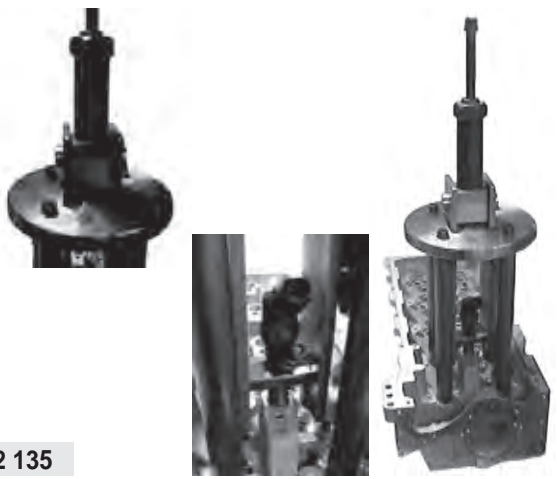

212 135

N.B.: solo per Mod. 220-250. Disponibile solo su ordinazione. Consegna 20 gg.lavorativi dall'ordine.

Estrattore per iniettori Mercedes con martello idraulico

Extractor for Mercedes injector with hydraulic

Acciaio. Zincato

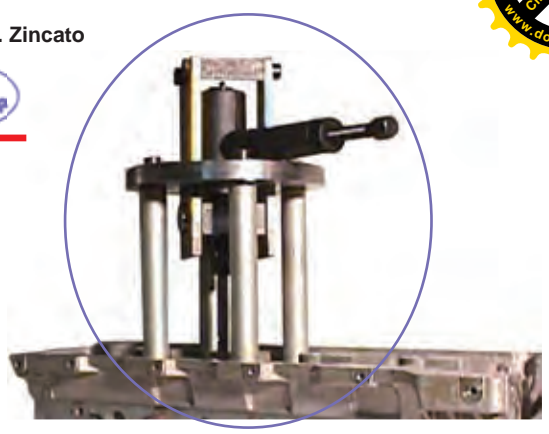

- 212 135 10 Capacità 8 ton.
- 212 135 20 Capacità 14 ton.

Descrizione - Description

- Piastra con guide registrabili per centraggio su testata
- Altezza al cestello mm 260
- Altezza alla piastra mm 155

Estrattore doppio per estrarre iniettori common-rail in coppia, per vetture con staffa di fissaggio iniettori a due a due

Double extractor for injector common-rail in pair

Acciaio. Zincato



212 136 Mercedes classe A

Estrattore iniettori Bosch flangiati Common Rail

Common-rail nozzle holders pullers



212 137

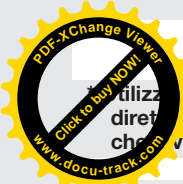

Utilizzo - Using

Quando la boccola (A) è possibile agganciarsi direttamente al filetto della bobina dell'iniettore, dopo di che avvitando il dado (B) si procede all'estrazione

Nel caso non si riesca ad estrarre nella maniera sopra indicata si consiglia di smontare la meccanica interna, poi utilizzando la chiavetta (C) si va a svitare il grano interno dell'iniettore, dopo di che inserendo la vite (D) al posto del grano e avvitando il dado (B) si può estrarre l'iniettore con più trazione

Ricambi - Spare-parts

212 137 01 Piastra rotonda

212 137 02 Coppia di colonnette con piedi



212 137 03 Boccola 27 x 1



212 134 10 Chiave Foro 6 - Esagono mm10

Adattatore per estrazione e controllo con pompa provainiettori Opel

Adaptor for extraction and check, utilizable with rig-test injection

Acciaio. Brunito

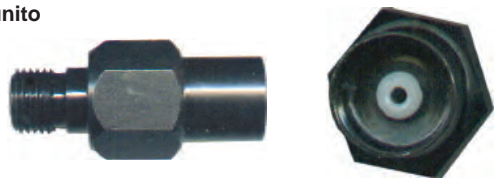

212 138 Opel

Chiave smontaggio pompe immerse Zexel

Wrench for removing immersel pump Zexel

Acciaio. Brunito

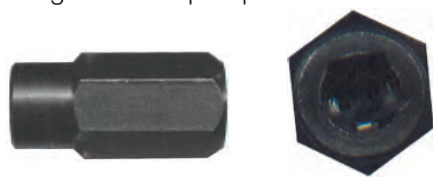

212 139 Bussole penta 3/8"

Morsetto per smontaggio iniettori

Clamp for nozzle holder



212 140 Mercedes-Fiat-Opel-Bmw ect Bosch

Morsetto per smontaggio iniettori

Clamp for nozzle holder



212 141 Polo D - Bosch

Morsetto per smontaggio iniettori

Clamp for nozzle holder



212 142 Peugeot-Renault - Cav

Chiave smonta iniettori

Wrench for nozzle holder dismantling

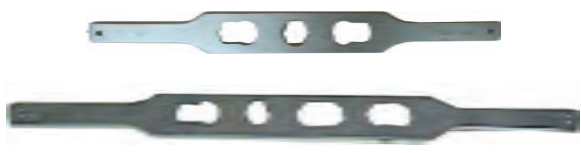

| | Quadro | Esagono |
|---------|-----------------------|---------|
| 212 143 | mm 17 - mm 19 - mm 22 | mm 22 |
| 212 144 | mm 17 - mm 19 - mm 21 | ----- |
| 212 145 | mm 22 - mm 24 | mm 27 |

Estrattore iniettori Bosch per Mercedes Sprinter

Extractor for Bosch injector - Mercedes Sprinter



Acciaio. Cr. V. Zincato

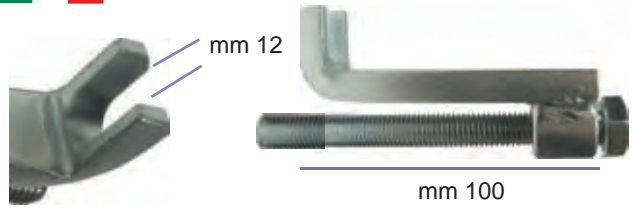

212 146

Blocchetto di fissaggio universale per smontaggio e montaggio iniettori Common-rail Bosch e Delphi

Universal wrench for assembly injector Common-rail

Acciaio.Brunito

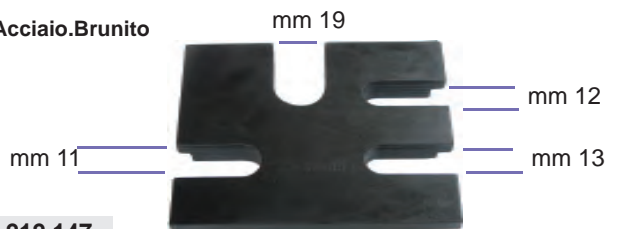

212 147

Blocchetto di fissaggio universale per smontaggio e montaggio iniettori Common-rail

Universal wrench for assembly injector Common-rail

Acciaio. Brunito

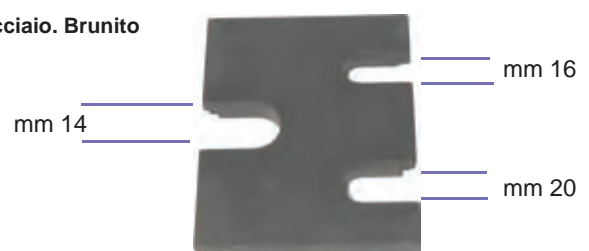

212 148 Bmw - Ducato - Volvo

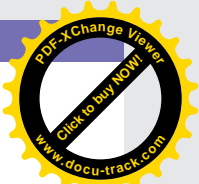

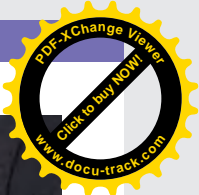
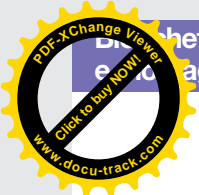

Supporto di fissaggio universale per smontaggio iniettori Common-rail

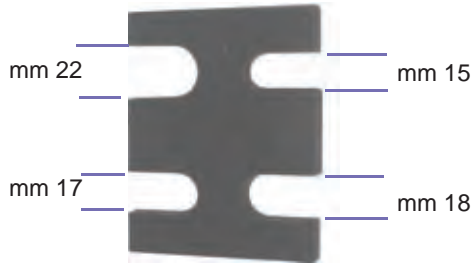

212 149

Piano rettificato per lappatura iniettori

Rectified flat for injector polish

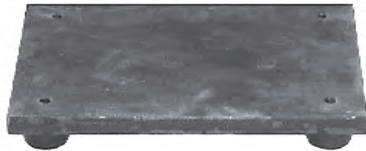

212 150 Universale - 250x220 mm

Morsetto per smontaggio iniettori

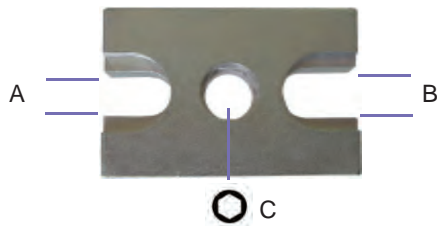

A mm 13 **B** mm 15 **C** Esagono mm 15

212 151

Kit estrattore a colpo per iniettori common rail motori Vw - Audi



212 152

Attrezzo allineamento iniettori Delphy su motori Ford

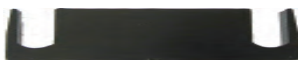

212 153

Estrattore iniettori common rail Bmw

Bmw common rail injectors



212 154 In valigetta Bmw: M47TU - M57 - M57TU

Dati tecnici - Informative

BMW 2.0d
118d E87 / 120d E87 / 320d E46, E90, E91 / 318d E90, E91 / X3 E83
BMW 2.5d
525d E39, E60, E61
BMW 3.0d
330d E46, E90, E91, E92, E93 / 335d E90, E91, E92 / X3 E83
530d E39, E60, E61 / X5 E53, E70 / 635d E63, E64 / X6 730d E38, E65, E66, F01, F02

Chiave 12 facce per smontaggio solenoide iniettori - Tector

Wrench 12 face for injector disassembly - Tector -

Acciaio zincato



212 155 Att. 1/2" - Ø 28

Kit estrattori iniettori

Nozzle extractor set

Specifico per motori:
PSA 2.0 - 2.2 HDI -JTD

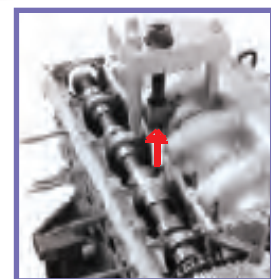

212 156 In valigetta

Composizione -Composition

- *1 corpo per estrazione iniettori
- *1 colonnetta lunga + 1 corta per appoggio corpo
- *1 vite M17 x 1 con dado M16 x 1,5 CH30 Bosch
- *1 vite M17 x 1 iniettori Siemens
- *1 bussola CH25 attacco 1/2" rimozione gruppo elettrico
- *1 bussola CH29 attacco 1/2" rimozione gruppo elettrico
- *1 chiave mm10 per rimozione solenoide

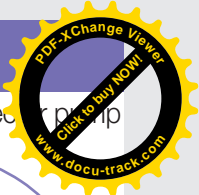
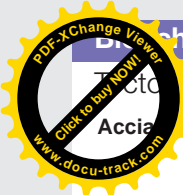

Chiave a T con attacco rapido e controllo iniettori Tector

Tector clamp with quick connection

Acciaio brunito



212 157

Descrizione - Description

- Utilizzabile in morsa durante la manutenzione dell'iniettore e applicabile alla pompa controllo iniettori

Chiave esagonale per lo smontaggio del solenoide iniettori-pompa

Wrench Exagonal for solenoid disassembly - injector pump

Acciaio brunito

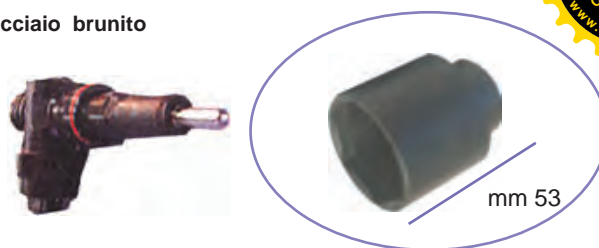

mm 53

212 161 Att. 1/2" - Vw - Audi A6 - Esagono mm 37 - Codice iniettori-pompa: 0.414.720.029 - 0.414.720.215

Chiave poligonale per dado elettrovalvole iniettori common rail - MAN -

Wrench poligonal for electrovalve common rail - MAN

Acciaio zincato

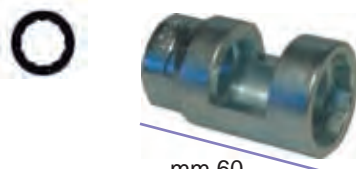

mm 60

212 158 Att. 1/2" - mm 27

Chiave ottagonale per smontaggio e rimontaggio solenoide iniettore pompa Bosch / Iveco

Wrench 8 face for solenoid disassembly

Acciaio zincato



mm 70

212 159 Att. 1/2" - Ø 38

Chiave 12 Punti per lo smontaggio del solenoide iniettori-pompa

Wrench 12 Point for solenoid disassembly - injector pump

Acciaio brunito



mm 50

212 160 Att. 1/2" - Vw - Audi A6 - Codice iniettori-pompa: 0.414.720.404

Chiave a 3 denti per lo smontaggio del tappo della pompa VP

Wrench 3 tooth for disassembly pump plug VP

Acciaio brunito



mm 53

212 162 Audi - Opel

Chiave con guida per lo smontaggio della ghiera interna degli iniettori Common-rail Siemens

Wrench for disassembly internal guide injector Common-rail Siemens

Acciaio brunito



212 163

Chiave per lo smontaggio dado polverizzatore del nuovo portainiettori Iveco Daily

Wrench for disassembly die new injector Iveco daily

Acciaio Zincato



Esagono esterno mm 27 Ottagono interno mm 17

212 164 Codice portainiettore: 0.445.110.273

Chiave per lo smontaggio dado polverizzatore degli iniettori - pompa Vw - Audi A6

Wrench for disassembly die injector VW - Audi a6

Acciaio Brunito

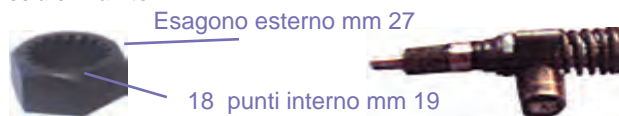

Esagono esterno mm 27

18 punti interno mm 19

212 165 Codice portainiettore: 0.414.720.404

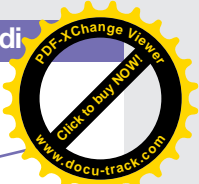
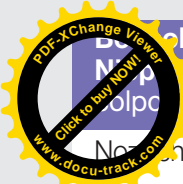

Chiave per estrazione iniettori Common-rail Nipodenso - Utilizzabile con nostro estrattore a colpo 212 126

Nozzle holder puller Denso

Acciaio Brunito



mm 35

Attacco F. 10 x 1.5 compatibile con nostro estrattore a colpo 212 126

212 166 Boccola

Chiave smontaggio ghiera interna iniettori Common-rail Nipodenso

Wrench for disassembly Comon-rail injector



3 Denti

mm 45

212 167

Chiave smontaggio per iniettori Common-rail Nipodenso con ghiera interna a tre fori

Wrench for remove injector Comon-rail Nipodenso

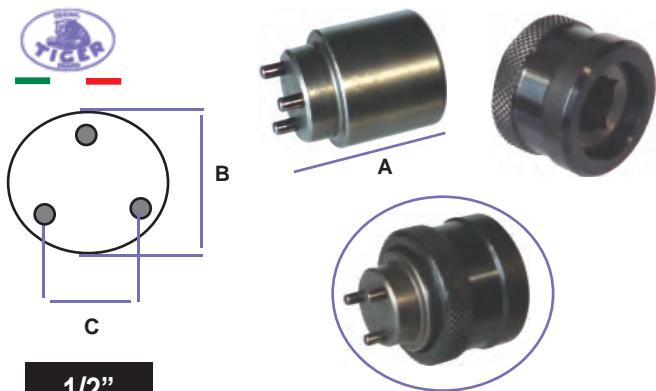

1/2"

| | A | B | C | Spine |
|------------|------|------|-------|-------|
| 212 167 01 | mm35 | mm20 | mm 12 | mm 3 |

Estrattore a colpo per pulverizzatore Iveco Tector

Wrench for nozzle sprayer Iveco Tector



mm 400

212 175

NOTE



Kit estrattori per bobine accensione Vw - Audi

Kit extractor for starter bobbin Vw - Audi

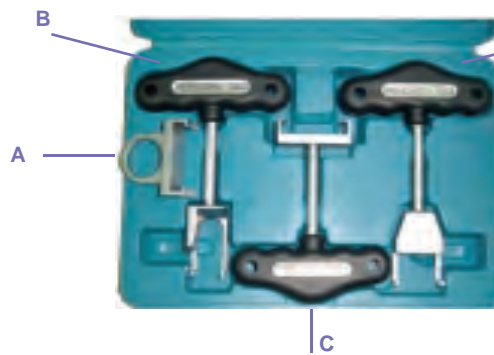

212 185 In valigetta - 4 Pz.

- Per vetture:

- (A) VW motori benzina 8 e 12 cilindri
- (B) VW Golf, Bora, Passat, Sharan, Touareg, Phateon - Touareg 6 cil. dal 2003 - Transporter T5 6 cil. iniezione benzina dal 2004
- (C) VW benzina iniezione diretta: Golf 2.0 dal 2004 - Touran dal 2004 - Passat dal 2006 - Eos dal 2006 . Audi benzina iniezione - diretta: A3 2.0 dal 2003 - A6 3.2 dal 2005.
- (D) VW ,Polo, Golf 1.4 - 1.6 / Caddy 1.4 / Bora 1.4 - 1.6 / Beetle - 1.4 - Lupo 4 cilindri.

Attrezzo smontaggio blocchetti accensione



212 190

Chiave poligonale per iniettori Delphi su motori Ford Mondeo e Transit

Wrench poligonal for injector Delphi - Mondeo - Transit



212 195 Att. 1/2" - mm 21 x 90

Chiave aperta per dadi tubetti iniettori

Wrench injection pipe fitting



212 200 Universale - 17 mm - esagonale

Chiave aperta per dadi tubetti iniettori

Wrench injection pipe fitting



212 201 Universale - Quadro 1/2" - 17 mm

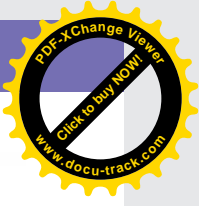
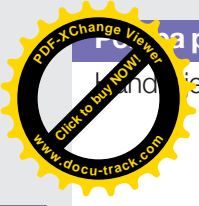

Manometro per controllo e taratura iniettori

Hand injector pump



212 210 Universale - 400 Bar

Ricambi - Spare-parts

212 211 Coppia Tubetti/hoses/Racordes

212 212 Vaso/Container/Recipiente.

Tester per iniettori Common-rail: Bosch, Delphi, Siemens e Denso (Bobina e Piezo)



212 205

Dati tecnici - Informative

*Pratico strumento per il controllo della parte elettrica di tutti gli iniettori common-rail, siano essi Elettromagnetici (Bobina) o Piezoelettrici (Piezo)

*Lo strumento deve necessariamente essere utilizzato con un qualsiasi modello di pompa prova-iniettore manuale (tipo nostra 212 215 di pag. 682) o EPS200, in questo modo è possibile controllare anche la pressione di ogni iniettore.

*I parametri visualizzati sono: - frequenza Hz - tempo di apertura ms - tensione di alimentazione

*Lo strumento è fornito di 4 cavi per bobine e piezo completi di cablaggio simile all'originale

*E' possibile scegliere tra 3 differenti tipologie di prove selezionando il tipo di iniettore, Bobina o Piezo, e il tipo di prova Tempo o Colpi - iniezione principale - pre-iniezione - iniezione pilota

Pompa per il controllo e la taratura degli iniettori

Hand injector pump



212 215 Universale - 400 Bar

Morsa girevole completa per smontare e rimontare le pompe Radial-jet

Revolving vice for disassembly Radial-jet pump



212 250

Flangia per smontare e rimontare le pompe: VE - VA - DPA - DPC - DPS

Flange for disassembly pump: VE - VA - DPA - DPC - DPS

Da utilizzare con Art-212 250
To be used with Art-212 250



212 251

Cassetta spessori per taratura iniettori Diesel

Box with mixer distance spacers for Diesel injector nozzle holders



212 301 Universale Diesel - 1500 pcs

Kit spessori per taratura iniettori meccanici Diesel

Box with mixer distance spacers for Diesel injector nozzle holder

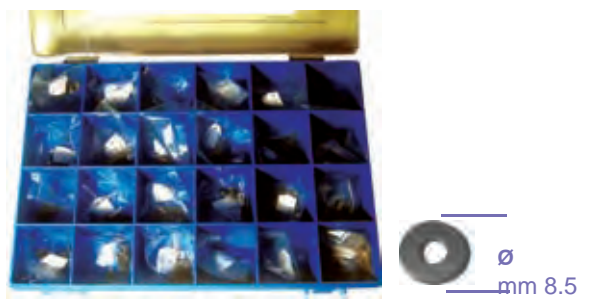

212 302 Spessori da mm 0.80 a 1.95 - Pz 480

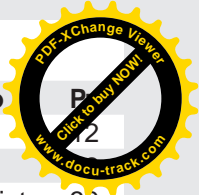
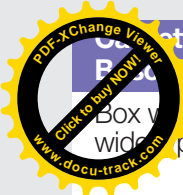

Cassetta pastiglie calibrate per portainettori Diesel tipo largo

Box with balance washers for Bosch nozzle holders wide type



212 303 Diesel Bosch - 480 pcs

Cassetta pastiglie calibrate per portainettori Diesel Cav tipo stretto

Box with balance washers for Cav nozzle holders narrow type



212 304 Diesel Cav - 400 pcs

Cassetta di parafiamma e rondelle per portainettori

Box with flame dampers and washers for nozzle holders



212 305 Diesel - 512 pcs

Assortimento rondelle parafiamma iniettori e raccordi



212 308 Valigetta Pz 551

Composizione -Composition

| | mm | Modello | Pz |
|-------------------|---------------------------------|--------------------|----|
| 212 308 01 | 7,3 x 13,7 x 2 | Kia | 12 |
| 212 308 02 | 7,3 x 13,6 x 3 | Kia | 12 |
| 212 308 03 | 7,5 x 16,5 x 2 | M.B.Sprinter | 30 |
| 212 308 04 | 7,5 x 15,5 x 1 | Man Rover | 12 |
| 212 308 05 | 7,5 x 15 x 1,5 | Fiat Ulysse | 12 |
| 212 308 06 | 7,5 x 13,5 x 1,5 | Ford Focus | 30 |
| 212 308 07 | 7 x 13 x 1,5 | Deuts | 12 |
| 212 308 08 | 7,5 x 15 x 3 | Renault Scenic | 30 |
| 212 308 09 | 7,5 x 15,5 x 1,5 | Land Rover | 12 |
| 212 308 10 | 7,5 x 15,5 x 2,5 | Ford Fiesta | 30 |
| 212 308 11 | Int. 3 punti - Est. 3 punti | Mazda | 12 |
| 212 308 12 | 8 x 15,45 x 2 con Gradino | Opel Mot. Isuzu | 30 |
| 212 308 13 | 7,5 x 15 x 2 con tacche | Iveco-Ford-Man-Bmw | 30 |
| 212 308 14 | 7,5 x 15 x 1,5 con tacche | Ford - Man - Bmw | 30 |
| 212 308 15 | 7,5 x 13 x 2,5 con tacche | Megane | 30 |
| 212 308 16 | 7 x 15 x 1,5 con gradino | Mercedes | 12 |
| 212 308 17 | 8 x 15 x 1,5 c/grad. bombata | Fiat Siemens | 30 |
| 212 308 18 | 6 x 10 x 1 Rondella in acciaio | | 45 |
| 212 308 19 | Base iniettore in Ottone | VW | 30 |
| 212 308 20 | Anello x base iniettore | VW | 30 |
| 212 308 21 | Molletta x raccordi | | 30 |
| 212 308 50 | Raccordi recupero gasolio a 90° | | 20 |
| 212 308 51 | Raccordi recupero gasolio a T | | 30 |

*NB: La composizione si intende per mezzi provati, le stesse misure e dimensioni possono essere uguali ad altre autovetture

Estrattore a percussione con maschio per parafiamma portainettori

Percussion puller with male for flame dampers Extractor a percusión para para llama



212 310 Diesel

Cassetta pulizia ugelli iniettori Diesel

Set for cleaning Diesel injectors



212 312 Diesel

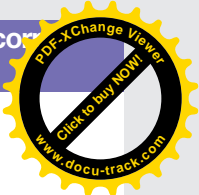
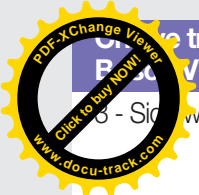

Chiave trilobata per coperchio attuatore su pompa Bosch VE - EDC

3 - Side wrench for actuator cover on Bosch - pump Ve - EDC

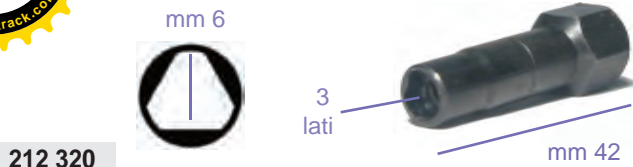

212 320

Chiave trilobata per serraggio collegamento elettronico Bosch VE - EDC

3 - Side wrench for tightening the electronic connection on Bosch VE - EDC



212 321

Chiave 1/2" regolazione anticipo pompe DPC

3 - Side wrench for actuator cover on Bosch - pump Ve - EDC



212 325

Raccordo pompe CP3 dente Ø 13.5C

3 - Side wrench for tightening the electronic connection on Bosch VE - EDC



212 326

Kit per smontaggio e rimontaggio bronzine corpo pompa Radial-jet CP1

Kit for disassembly bronze pump Radial-jet CP1

212 330

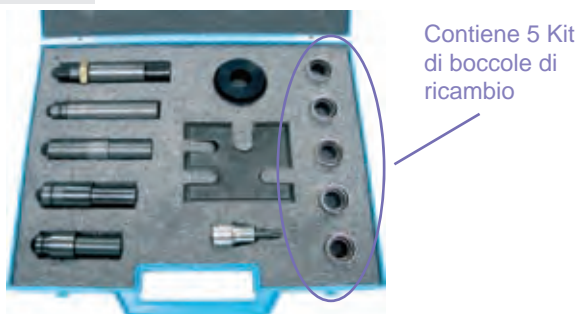

Contiene 5 Kit di boccole di ricambio

Kit per smontaggio e rimontaggio bronzine corpo pompa Radial-jet CP3

Kit for disassembly bronze pump Radial-jet CP3

212 335

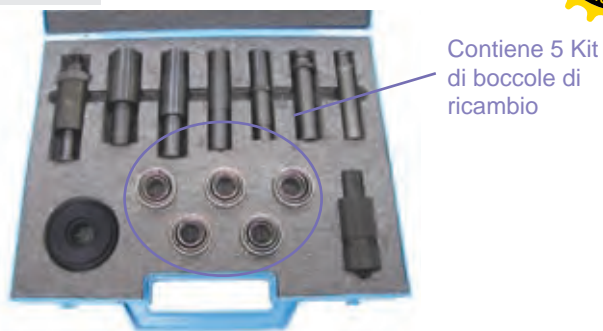

Contiene 5 Kit di boccole di ricambio

Chiave Ribe speciale per smontaggio-montaggio tappi pompa common-rail CP3

Wrench -RIBE- for disassembly pump Common-rail

212 336

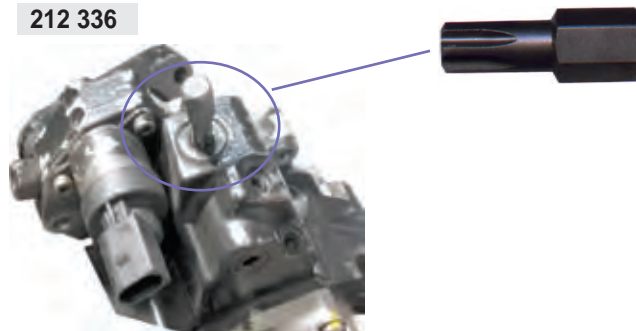

Cassetta completa per smontaggio e montaggio pompe Bosch "P" con comparatore

Set for disassembly pump Bosch "P"

212 340



Cassetta per smontaggio e montaggio pompe rotative EP - VE

Set for disassembly rotary pump EP - VE

212 345



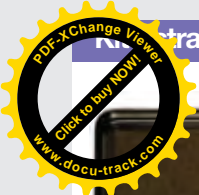

Estrazione / Riparazione candele spezzate



Made in Germany

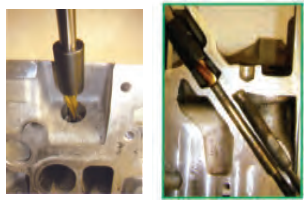

- 212 346 mm 8 x 1
- 212 347 mm 9 x 1
- 212 348 mm 10 x 1

Estrattore a colpo utilizzabile con 212 346 - 212 347 - 212 348



mm 280



212 348 01

Kit 6 bussole estrazione candele



Dis. elicoidale

- 212 348 06 mm: 2,6 - 3,2 - 3,5 - 4,5 - 6,5 - 8,25

Kit 4 frese per pulizia interna sede iniettori Common-Rail tipo Bosch-Delphi

Diesel injector seat cutter set
Acc. HSS - Brunito



212 349 Pz 5

Ricambi - Spare-parts

- 212 349 01 Fresa piana - Ø17 - dente 17
- 212 349 02 Fresa piana - Ø19 - dente 17
- 212 349 03 Fresa conica - Ø19 - dente 15
- 212 349 04 Fresa conica - Ø21 - dente 17
- 212 349 05 Perno porta fresa

Kit 4 frese per pulizia interna sede iniettori Common-Rail tipo Bosch-Delphi

Diesel injector seat cutter set
Acc. HSS - Brunito

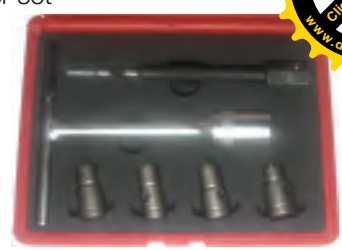

212 350 Pz 5

Composizione - Composition

- 212 349 01 Fresa piana - Ø17 - dente 17
- 212 349 02 Fresa piana - Ø19 - dente 17
- 212 349 03 Fresa conica - Ø19 - dente 15
- 212 349 04 Fresa conica - Ø21 - dente 17
- 212 349 05 Perno porta fresa -

Chiave di manovra non disponibile.

Kit frese per la pulizia interna sedi iniettori

9 Pcs Diesel injector seat cutter set



212 350 09 Pz 9

Composizione - Composition

| | mm A | mm B | mm C |
|---------------|------|------|------|
| Fresa Piatta: | 19 | 15 | 38 |
| Fresa Piatta: | 17 | 17 | 38 |
| Fresa Piatta: | 19 | 17 | 38 |
| Fresa Piatta: | 19 | 19 | 50 |
| Fresa Conica: | 17 | 17 | 38 |
| Fresa Conica: | 21 | 17 | 38 |

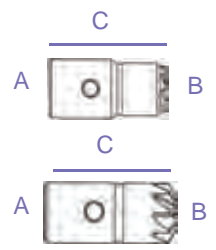

212 349 05 Perno porta frese

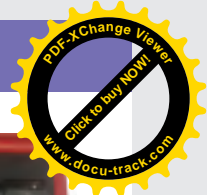

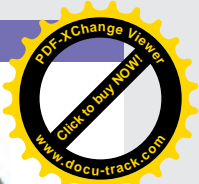
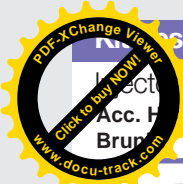

Fresa di pulizia modello AFA

Injector seat cutter set AFA



212 350 10 Pz 5

Ricambi - Spare parts

- 212 350 11 Fresa piana - Ø17 - dente 17 - Delphi
- 212 350 12 Fresa piana - Ø19 - dente 17 - Bosch
- 212 350 13 Fresa conica - Ø21 - dente 17 - Bosch
- 212 350 14 Fresa piana - Ø19 - dente 15 - Sprinter
- 212 350 30 Perno porta fresa

Frese di pulizia modello AFA

Injector seat cutter set AFA



- 212 350 15 Fresa x iniettori Tector
- 212 350 16 Fresa piana per iniettori Audi A6
- 212 350 17 Fresa conica per iniettori Iveco DIALY
- 212 350 18 Fresa elettroiniettori pompa Vw
- 212 350 30 Perno porta fresa

Kit pulizia sede iniettori con centratori

Diesel injector seat cutter set with extractor for injector ring and brush



212 350 50 Kit pulizia sede iniettori con centratori, estrattore rondelle in rame e scovoli, per motori Hdi, diesel iniezione diretta e common rail con iniettori Bosch e Delphi

Composizione - Composition

- Pz 1 Asta porta frese
- Pz 1 Fresa piana Ø 19 - dente Ø 15
- Pz 1 Fresa piana Ø 19 - dente Ø 17
- Pz 1 Fresa conica Ø 17 - dente Ø 17
- Pz 3 Puntatori conici con imbocco Ø 17 - 18 - 19
- Pz 1 Estrattore rondelle in rame
- Pz 1 Flessibile con adattatori per scovoli
- Pz 2 Scovoli (mm 300)
- Pz 2 Scovoli (mm 90)
- Pz 1 Asta filettata Ø5 x mm 200 con 6 boccole Ø7 x mm 15

Fresa pulizia iniettori CDI

Mill for cleaning injectors CDI

Made in Germany



212 351

mm 50

Kit frese pulizia iniettori CDI

Kit mills cleaning injectors CDI

Made in Germany



212 352

Kit estrazione / riparazione candele spezzate

9 pcs glow plug removal set



212 354 mm 8 - mm 10 - In valigetta

Adattatore opzionale - Optional adaptor

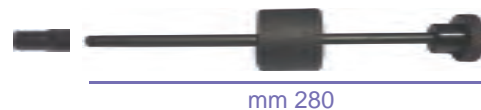

mm 280

- 212 348 01 Estrattore a percussione con filetto M 10 x 1,5
- 212 354 01 Boccola F 10 x 1,5 / F 8 x 1,25 per collegare l'estrattore ai perni di estrazione
- 212 354 02 Coppia perni filettati 8 x 1.25

Utilizzo - Utilization

Boccola F 8 x 1,25 / 10 x 1,5

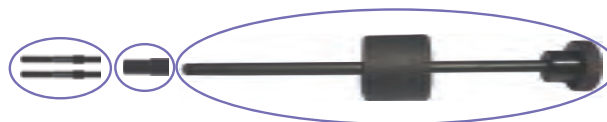

Perni di estrazione con attacco filetto maschio 8 x 1,25 contenuti nel Kit 212 354

Estrattore a percussione 212 348 01 con filetto maschio 10 x 1,5

Adattatori opzionali - Optional adaptor



212 354 10 Punta maschio e perni per estrazione candele sottili Ø 8

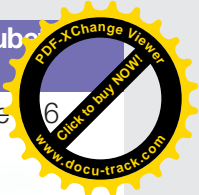
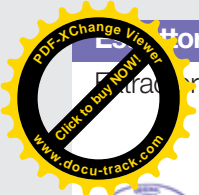

Fore rondelle in rame iniettori

Injector for injector ring



212 355

Ricambi - Spare parts

212 355 01 Pinza

212 355 02 Astina

Kit avvitatore-vibro con 3 bussole per estrazione candele

Made in Germany



Unico sistema vibrante per l'estrazione delle candele senza correre il rischio delle classiche rotture durante questa operazione. Indispensabile con i motori Mercedes



212 356 Avvitatore-vibro da 1/4" + snodo + 3 bussole - impact esagonali mm 8 / 10 / 12

Coppia estrattori ad alta resistenza per i giunti di trascinamento utilizzabile su 11 tipi di pompe VP

Couple extractor very resistant for joint trail. Utilizable on 11 type VP pump



212 360

Pressa idraulica per creazione del cono su tubi iniettori - Ø 6

Hydraulic press for creation cone on injectortube

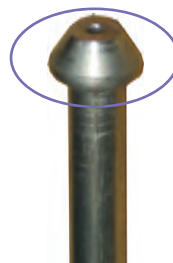

212 380

Nuove vasche riscaldanti ad ultra-suoni

L'ultrasuono raggiunge il liquido detergente riscaldato creando delle microbolle che implodono con grande energia. Queste sciolgono e puliscono con forza ma senza denneggiare anche le parti più delicate e irraggiungibili

Vasca lavaggio ultrasuoni riscaldante.

Ultrasonic cleaning tanks

Acc. INOX ideali per pompisti

Cestello in rete OPTIONAL

Cestello porta iniettori di serie

Potente e veloce per la pulizia degli iniettori, delle leghe metalliche, ceramiche, vetro. Fornita di cestello porta iniettori con coperchio

- 212 390 Capacità Lt. 3
- 212 390 01 Cestello porta iniettori - RICAMBIO -
- 212 390 02 Cestello in rete - OPTIONAL -

Dati tecnici - Informative

| | |
|----------------------|------------------------------|
| Dotata di: | Timer - Termostato - Scarico |
| Potenza Ultra-suono: | W 100 / 200 |
| Potenza riscaldante: | W 250 |
| Dimensioni interne: | 235 x 140 x 120h |
| Dimensioni esterne: | 300 x 360 x 220h |
| Alimentazione: | V 220 |

NOTE



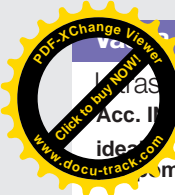

Vasche lavaggio ultrasuoni riscaldante.

Ultrasonic cleaning tanks

ideali
per pompisti



Cestello
in rete
OPTIONAL

Cestello
porta iniettori
di serie

Potente e veloce per la pulizia degli iniettori, delle leghe metalliche, ceramiche, vetro. ornita di cestello porta iniettori con coperchio

212 391 Capacità Lt. 7

212 39101 Cestello porta iniettori - RICAMBIO -

212 39102 Cestello in rete - OPTIONAL -

Dati tecnici - Informative

Dotata di: Timer - Termostato - Scarico
Potenza Ultra-suono: W 200 / 400
Potenza riscaldante: W 500
Dimensioni interne: 330 x 140 x 170h
Dimensioni esterne: 400 x 300 x 320h
Alimentazione: V 220

Vasca lavaggio ultrasuoni riscaldante.

Ultrasonic cleaning tanks

Acc. INOX
ideali
per pompisti



Cestello
in rete
OPTIONAL

Cestello
porta iniettori
di serie

Potente e veloce per la pulizia degli iniettori, delle leghe metalliche, ceramiche, vetro. Fornita di cestello porta iniettori con coperchio

212 392 Capacità Lt. 14

212 392 01 Cestello porta iniettori - RICAMBIO -

212 392 02 Cestello in rete - OPTIONAL -

Dati tecnici - Informative

Dotata di: Timer - Termostato - Scarico
Potenza Ultra-suono: W 300 / 600
Potenza riscaldante: W 750
Dimensioni interne: 330 x 235 x 200h
Dimensioni esterne: 360 x 260 x 450h
Alimentazione: V 220

Detersivi Diluiti per lavatrici ad ultrasuoni riscaldanti

212 393 02 Per Alluminio / Iniettori elettrici T-909 Lt 2

212 393 05 Per Acciaio & Iniettori diesel A16 Lt 2

212 393 08 Neutro x leghe AU/AG A90 IZ Lt 2

NB: Il detersivo 212 39305 è:

incompatibile con:

Rame - Zinco - Alluminio e leghe in genere
utilizzabile su Acciaio e Ferro per l'asportazione di
Residui carbonosi - Colle - Vernici ecc..

Vasche lavaggio di grande affidabilità indicate principalmente a officine meccaniche

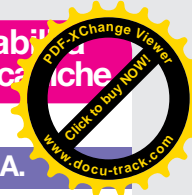

Vasche lavaggio ultrasuoni riscaldanti - A.F.A.

Ultrasonic cleaning tanks import

Acc. INOX

KHz
40



Cestello in rete
di serie



(NB: cestello porta-
iniettori non disponibile)

| | Dimensioni EST. | Dimensioni INT. | Capacità Lt. |
|---------|-----------------|-----------------|--------------|
| 212 395 | 265 x 165 x 240 | 235 x 135 x 100 | 2,5 |

Ricambi - Spare parts

| | | Dimensioni INT. | Capacità Lt. |
|------------|------------------|-----------------|--------------|
| 212 395 01 | Cestello in rete | 230 x 128 x 95 | 2,5 |

Dati tecnici - Informative

Dotate di: Timer e Scarico / Temperatura: °C 80
Alimentazione: V 220 / Frequenza ultrasuoni: 40KHz

Vasche lavaggio ultrasuoni riscaldanti - A.F.A.

Ultrasonic cleaning tanks import

Acc. INOX

KHz - 40



Cestelloporta iniettori +
cestello in rete di serie



| | Dimensioni EST. | Dimensioni INT. | Capacità Lt. |
|---------|-----------------|-----------------|--------------|
| 212 399 | 285 x 285 x 210 | 230 x 135 x 100 | 3 |

Ricambi - Spare parts

212 399 01 Cestello in porta iniettori

Dati tecnici - Informative

Dotate di: Timer e Scarico / Temperatura: °C 80
Alimentazione: V 220 / Frequenza ultrasuoni: 40KHz



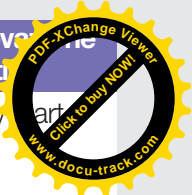
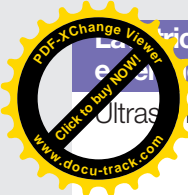

Spazzino ad ultrasuoni per iniettori Benzina e Diesel piccoli particolari metallici

Ultrasonic cleaner

Capacità 0,75 Lt



212 400 Lavatrice con tanica

Ricambi - Spare-parts

212 405 Tanica Lt. 2

Dati tecnici - Informative

L'ultrasuono accelera il progresso di disgregazione delle particelle di sedimento depositate negli iniettori

- 19 watt
- Frequenza 40 Khz
- Capacità Lt. 0,75

Kit lappatura sede sfera ritorno gasolio interna all'iniettore Common-rail

Mill for cleaning injectors CDI

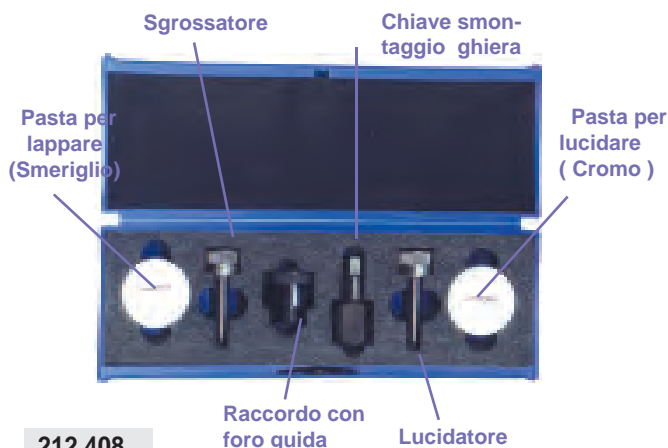

212 408

Cassetta pulizia pozzetti ugelli iniettori Diesel

Set for cleaning Diesel injectors



212 410 Diesel



Cassetta di supporti con comparatori per rilevazione quota di mandata sulle pompe in linea e rotative

Set of support for dial gauge to survey the delivery start on rotary and on line BOSCH pumps



212 411 Bosch EP/VA...B-C-BV-VE - Diesel

Kit supporto comparatori per mandata pompe rotative carburante

Kit I support comparators for sent pump fuel

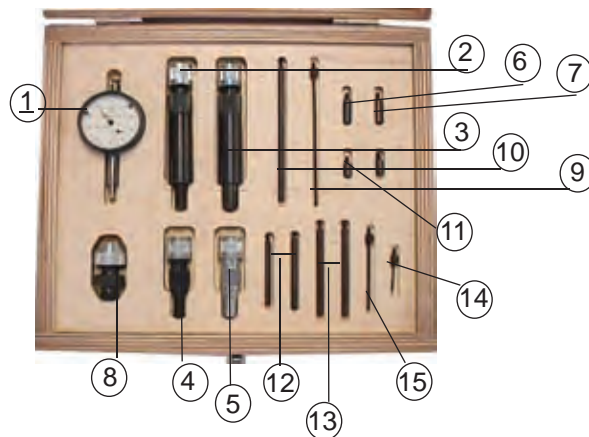

212 412 BOSH EP/VE autocarri - Nuovi modelli auto iniezione diretta AUDI-OPEL-FORD

Composizione:

01. Comparatore centesimale corsa mm 5
02. Supp.comp.prolungato per rilevamento fase su rotative BOSH EP VE - 8x1 mm
03. C.S. - EP VE iniezione diretta, filetto maggiorato 10x1 mm
04. Supporto comp.per fase rotative BOSH EP VE - 8x1 mm
05. Supp.Comp. pompe BOSH EP VE - 10x1 mm
06. Riduzione maschio mm3 femmina mm 2,5 - lungh.16 mm
07. Riduzione maschio mm2,5 femmina mm 3 - lungh.16 mm
08. Supp.Comp. pompe BOSH EP VA - 12x1 mm
09. Astina mm 94 - diam. mm 2 - filetto 2,5 mm
10. Astina mm 94 - diam. mm 4 - filetto 2,5 mm
11. Coppia puntalini - diam. mm 4 - filetto 2,5 e 3 mm
12. Coppia Astine mm 40 - diam. mm 4 - filetto 2,5 e 3 mm
13. Coppia Astine mm 58 - diam. mm 4 - filetto 2,5 e 3 mm
14. Astina mm 25 - diam. mm 2 - filetto 2,5 mm
15. Astina mm 52 - diam. mm 2 - filetto 2,5 mm

Cassetta di supporti con comparatori per rilevazione quota di mandata sulle pompe rotative BOSCH e CAV

Set of support for dial gauge to survey the delivery start on rotary BOSCH and CAV pumps



212 413 Bosch EP..VA...VE -CAV DPA DPC DPS - ROTO DIESEL - Diesel

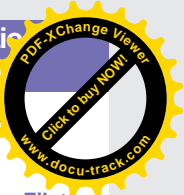
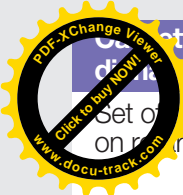

Cassetta di supporti per rilevazione quota mandata sulle pompe rotative BOSCH

Set of support for dial gauge to survey the delivery start on rotary BOSCH pumps



212 415 Bosch EP/VA...C-VE 6x1 8x1 10x1 - Diesel

Cassetta di supporti con comparatori per rilevazione quota di mandata sulle pompe rotative BOSCH

Set of support for dial gauge to survey the delivery start on rotary BOSCH pumps



212 418 Bosch EP/VE -Vetture e autocarri medi e nuove auto con iniezione diretta Audi-Ford ect.

Cassetta di dispositivi luminosi per verifica segnale agli iniettori benzina

Set of light devices for checking the contact into gasoline injectors



212 420 Bosh Ford GM Geo

Supporto portacomparatore per controllo inizio mandata pompa iniezione a distributore rotante

Tool for checking beginning of delivery of distributor type fuel injection pump



212 421 Bosch-Cav8x1 - 12x1,25

Supporto portacomparatore per controllo inizio mandata pompe iniezione a distributore rotante

Tool for checking beginning of delivery of distributor type fuel injection pump

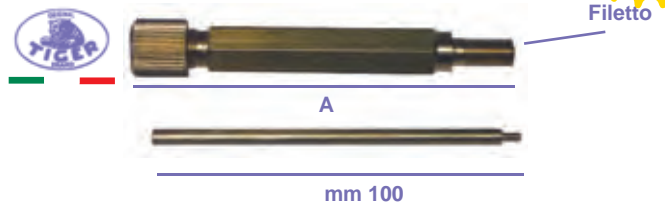

| | A | Filetto |
|----------------|-----|---------|
| 212 422 | 105 | Ø 10x1 |
| 212 423 | 105 | Ø 8x1 |

Supporto portacomparatore per controllo inizio mandata pompa iniezione a distributore rotante

Tool for checking beginning of delivery of distributor type fuel injection pump



212 424 Bosch EP-VA - 6x1
212 425 Bosch VE Punto 1698 D - 8x1
212 426 Bosch EP-VE - 10x1

Supporto portacomparatore per controllo inizio mandata pompa iniezione a distributore rotante

Tool for checking beginning of delivery of distributor type fuel injection pump



212 427 Fiat 242 D - 12x1

Supporto portacomparatore per controllo inizio mandata pompa iniezione a distributore rotante

Tool for checking beginning of delivery of distributor type fuel injection pump



212 428 Ford 1600 D - 8x1,5

Set supporti portacomparatore per controllo inizio mandata pompa iniezione a distributore rotante

Set of tools for checking beginning of delivery of distributor type fuel injection pump



212 430 6x1 - 8x1 - 8x1 lungo - 10 x1

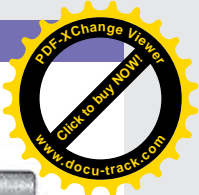
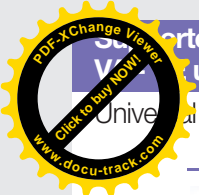

**Chiave comparatore universale per fase bilancino
utilizzabile per ingombri ridotti**

Universal wrench for balance VA - VE

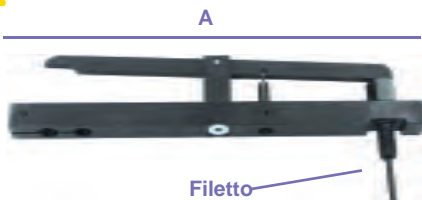

| | A | Filetto |
|---------|-----|----------|
| 212 432 | 180 | Ø 8 x 1 |
| 212 433 | 180 | Ø 10 x 1 |

**Kit montaggio/smottaggio/regolazione pompe
iniezione CAV e Perkins**



212 440

Composizione: 212 441 - 212 442 - 212 443 - 411 751

- 212 441 Cacciavite pentaTorx forato Ø5x80
- 212 442 Cacciavite pentaTorx forato Ø8x120
- 212 443 Inserto pentaTorx forato Ø8x30 - Att. 5/16"
- 212 444 Inserto pentaTorx forato Ø5x30 - Att. 1/4"

Coppia giraviti per regolazione carburatori

Twin screwdriver for injection adjusting



212 501 Vetture giapponesi

**Chiave per lo smontaggio della turbina - per motori
Diesel Vw - Audi**

Special wrench for turbo



212 509

Chiave distributore di accensione

Wrench for distributor



212 510 Twingo - 13 mm

Chiave per regolazione cavi acceleratore

Wrench for accelerator hollow regulation



212 511 Tipo Tempra - 13 mm

**Chiave montaggio sensore su testa cilindri e
dispositivo di arresto motore su pompa iniezione**

Wrench for mounting sensor on cylinder head
and sensor of stop injection pump



212 512 Croma TD-Alfa 164-164 Q4 Regata D-Tipo D-Croma
D-Punto TD BOSCH - 24 mm

Chiave viti fissaggio collettore turbo

Wrench for collector turbo compressor nut



212 513 Fiat Croma TD-Thema TD - 13 mm

Chiave ghiera serbatoio carburante

Wrench for fuel tank nut



212 601 Bravo-Brava-mot. 1370-1581-1747-1998

Chiave ghiera serbatoio carburante

Wrench for fuel tank nut



212 603 Fiat Ritmo-Croma

Chiave ghiera serbatoio carburante

Wrench for fuel tank nut



212 605 Croma-Thema-Alfa 164

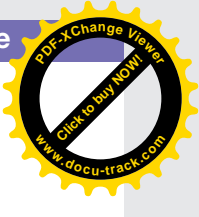

Chiave per montaggio - smontaggio ghiera Cup wrench for fuel tank nut, con tacca di presa su dente ghiera

Cup wrench for fuel tank nut

Esagono di manovra saldato su slitta mobile. Possibilità di posizionamento sempre sull'asse centrale di lavoro

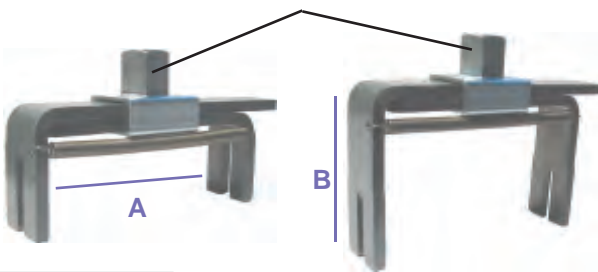

212 609 Pz 2

Composizione - Composition

212 609 01 A mm 100 - 170 - B mm 40

212 609 02 A mm 100 - 170 - B mm 60

Chiave ghiera serbatoio carburante

Wrench for fuel tank nut

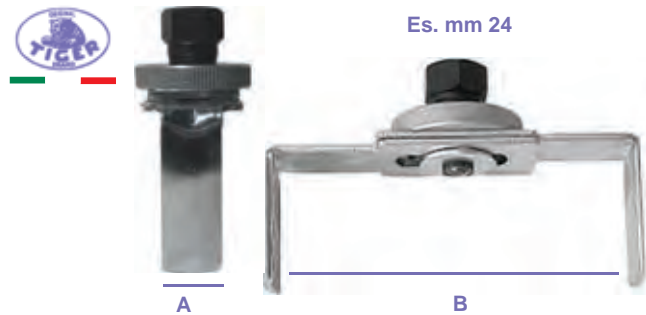

| | A | B |
|---------|----|-----------|
| 212 610 | 19 | 78 - 120 |
| 212 611 | 25 | 118 - 165 |
| 212 612 | 25 | 165 - 205 |

Chiave manovra indicatore di livello carburante su serbatoio

Wrench for fuel indicator nut



212 613 Nuova 500

212 614 Punto

Chiave manovra indicatore di livello carburante su serbatoio

Wrench for fuel indicator nut



212 615 Fiat Tipo.

Chiave manovra galleggiante del carburatore

Wrench for carburettor floating nut



212 619 Alfa 155

Chiave serbatoio carburante a 3 zampe

Fuel tank cup wrench

Acciaio cromato



212 620 Ø 75 - 160

Pinze per cappucci candele e raccordi rapidi

Glow-Plug connector plier



mm 235



mm 245

212 900 Pinza con becchi piegati a 90°

212 901 Pinza con becchi dritti

Tubo in gomma flessibile resistente al calore per rimozione candele

Spark pipe - flexible -

212 920

Made in Germany



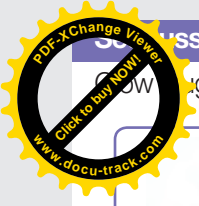

Bussole dinamometriche per candele

kg torque limited socket



mm
12 mm
10 mm
8



Max kg: 1,5

Max kg: 1,8

212 990

mm 8

mm 10 & 12

Kit n bussole con chiavi di manovra per candele JTD, in comoda valigetta di plastica

Wrenches with sockets for plugs



Esagono profondo per candele

1/4"

Att: mm

Pz

212 995

1/4" 7 - 8 - 9 - 10 - 12 - 1/4" - 3/8"

9

Ricambi - Spare-parts

- 212 995 01 Asta a "T" con quadro scorrevole
- 212 995 02 Cacciavite porta bussole con quadro maschio / femmina da 1/4"
- 212 995 07 Bussola esagonale per candele mm 7
- 212 995 08 Bussola esagonale per candele mm 8
- 212 995 09 Bussola esagonale per candele mm 9
- 212 995 10 Bussola esagonale per candele mm 10
- 212 995 12 Bussola esagonale per candele mm 12
- 212 995 14 Bussola esagonale per candele 1/4"
- 212 995 38 Bussola esagonale per candele 3/8"

NOTE



Set chiavi corte e lunghe per candele preriscaldamento

Kit wrench for little spark plug preheating



212 998 Pz 10

Composizione - Composition

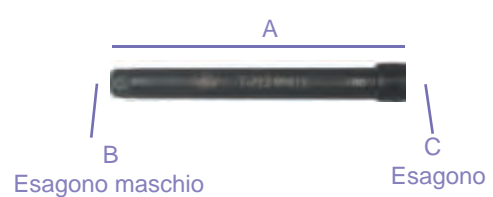

| | A | B | C |
|------------|--------|-------|-------|
| 212 998 08 | mm 60 | mm 10 | mm 8 |
| 212 998 09 | mm 60 | mm 10 | mm 9 |
| 212 998 10 | mm 60 | mm 10 | mm 10 |
| 212 998 12 | mm 60 | mm 10 | mm 12 |
| 212 998 18 | mm 120 | mm 10 | mm 8 |
| 212 998 19 | mm 120 | mm 10 | mm 9 |
| 212 998 20 | mm 120 | mm 10 | mm 10 |
| 212 998 22 | mm 120 | mm 10 | mm 12 |

- 411 755 Bussola portainsero Esag. fem. mm 10 - Attacco 3/8"
- 411 756 Bussola portainsero Esag. fem. mm 10 - Attacco 1/2"

Chiave a cricchetto poligonale per candele preriscaldamento

Wrench for little spark plug preheating



212 999

Chiave a "T" per candele preriscaldamento Alfa 166

Wrench for little spark plug preheating Alfa 166

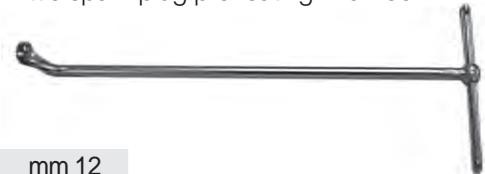

213 000 mm 12

Chiave smontaggio candele di preriscaldamento

Wrench for removing and refitting little spark plug of warming



- 213 001 Universale - 12 mm
- 213 002 Universale - 10 mm



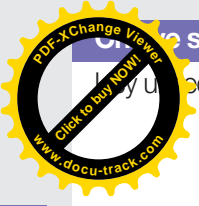

Chiave snodata 3/8" c/magnete per candelette

Key used with magnet for little spark plug



- 213 003 mm 10
- 213 004 mm 12

Chiave per candele di accensione

Spark plug wrench



- 213 005 70 mm - esag. 17 mm - 16 mm
- 213 006 60 mm - 1/2" - 11/16"
- 213 007 80 mm - esag. 17 mm - 20,8 mm

Chiave snodata 1/2" per candelette preriscaldamento



- 213 008 3/8" - mm 8
- 213 008 01 1/2" - mm 8
- 213 009 3/8" - mm 9

Chiave per candele di accensione

Spark plug wrench



- 213 010 Lung./Len/La 175 mm - Alfa 33 - 16 mm

Chiave candela a tubo con gommino resistente al calore per ritegno candela BMW 16V



- 213 011 C/fori per spina - L= 300mm es. mm 16
- 213 01101 con quadro 1/2" - L= 300mm es. mm 16

Chiave candela a tubo con gommino resistente al calore per ritegno candela.

Wrench for spark plug



RENAULT CLIO 1.2 16V



- 213 014 L= 250mm C/foro per spina es. mm 14
- 213 014 01 L= 250mm C/Att.1/2" - es. mm 14

Chiave poligonale extrasottile per candela

Spark plug sock

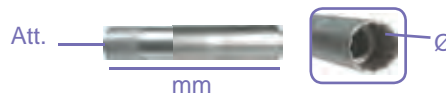

- | | Att. | Ø | mm |
|------------|------|----|----|
| 213 014 14 | 3/8" | 14 | 62 |

Chiavi poligonali extrasottili per candela

Spark plug sock

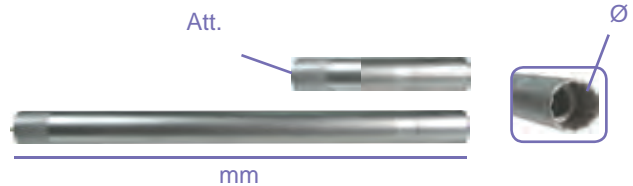

- 213 014 20 Set 2 chiavi (213 01415 + 213 01416)

Composizione - Composition

- | | Att. | Ø | mm |
|------------|------|----|----|
| 213 014 15 | 3/8" | 14 | 90 |

Ideale per:

- BMW E90 N54 Motor 335i Lim.Ab.Bj .2006
- Renault Modus Twingo,Clio,Kangoo 1,2 l 16V
- Peugeot 207, 307
- Citroen C5, 2.0i ,HPi
- Motor,Mercedes-Benz Motor M156 - NISSAN Micra.

- | | Att. | Ø | mm |
|------------|------|----|-----|
| 213 014 16 | 3/8" | 14 | 250 |

Ideale per: Citroen C5 HPI, Peugeot 406 HPI, Mini one

Chiave fresata per candele di accensione

Special Spark plug wrench

Acc.Cr.V.
Cromate



- 213 015 20.8 mm
- 213 016 16 mm

Kit 4 pezzi chiavi candelette snodate con asta di manovra sfilabile

Spark plug socket set

Acc.Cr.V.

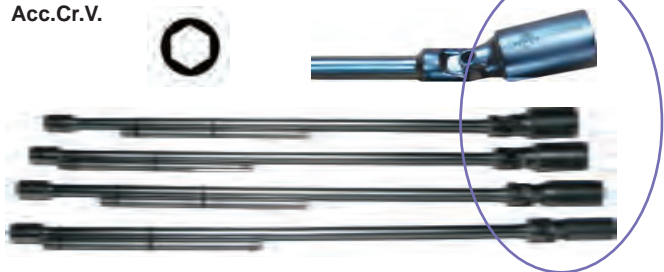

mm 500

- 213 017 mm 8 - 9 - 10 - 12 4 Pz

Ricambi - Spare-parts

- 213 017 08 Chiave singola mm 8
- 213 017 09 Chiave singola mm 9
- 213 017 10 Chiave singola mm 10
- 213 017 12 Chiave singola mm 12

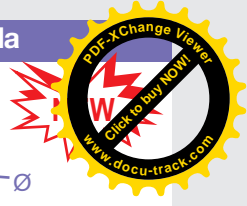

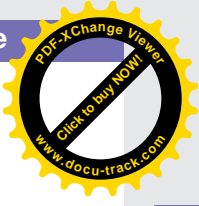
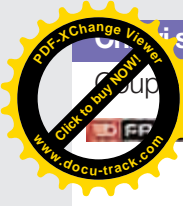

Chiave snodata lunga per candelette preriscaldamento

Long joint wrench for little spark plug

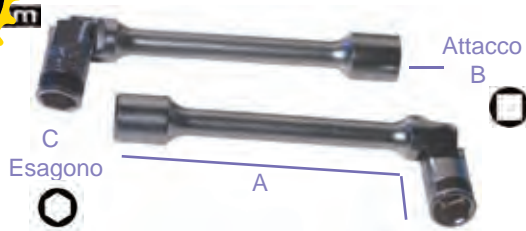

| | A | B | C |
|------------|-----------------|--------|--------------|
| 213 018 08 | Venduta singola | mm 160 | 3 / 8" mm 8 |
| 213 018 09 | Venduta singola | mm 160 | 3 / 8" mm 9 |
| 213 018 10 | Venduta singola | mm 160 | 3 / 8" mm 10 |
| 213 018 12 | Venduta singola | mm 160 | 3 / 8" mm 12 |

Set 6 Pz chiavi snodate lunghe per candele e candelette di accensione per motori Common-rail

Set 6 Pz long wrench for little spark starter Common-rail



213 019 Pz. 6

Composizione - Composition

| | A | B | C |
|-----------|--------|--------|------------------|
| 213 01908 | mm 150 | 3 / 8" | mm 8 = (5 / 16") |
| 213 01909 | mm 150 | 3 / 8" | mm 9 |
| 213 01910 | mm 150 | 3 / 8" | mm 10 |
| 213 01912 | mm 150 | 3 / 8" | mm 12 |
| 213 01914 | mm 150 | 3 / 8" | mm 14 |
| 213 01916 | mm 150 | 3 / 8" | mm 16 |

Chiave di servizio per candele di accensione

Service Spark plug wrench



213 020 Ciclomotore - 20.8 mm

Chiave di servizio per candele di accensione

Service Spark plug wrench



| | | |
|---------|-------------|-------------------------|
| 213 022 | VESPA a 90° | 11 mm - 13 mm - 20.8 mm |
| 213 023 | VESPINO | 11 mm - 13 mm - 20.8 mm |
| 213 024 | VESPINO | 13 mm - 13 mm - 20.8 mm |
| 213 025 | VESPINO | 13 mm - 17 mm - 20.8 mm |
| 213 026 | VESPINO | 11 mm - 17 mm - 20.8 mm |

Chiave di servizio per candele di accensione

Service Spark plug wrench



213 028 LAMBRETTA - 13 mm x 20.8 mm

Chiave di servizio per candele di accensione

Service Spark plug wrench



213 030 19 mm
213 031 20.8 mm

Chiave snodata con magnete smontaggio candele quadro 3/8"

Joint wrench for spark plug of warming square 3/8"



213 038 Universale - 14 mm -
Da usare con 414 342-414 388-414 392

Chiave snodata per candele di accensione

Spark plug wrench



213 040 300 mm - 20.8 mm

Kit 4 pezzi chiavi candelette snodate con asta di manovra sfilabile

Spark plug socket set

Acc.Cr.V.

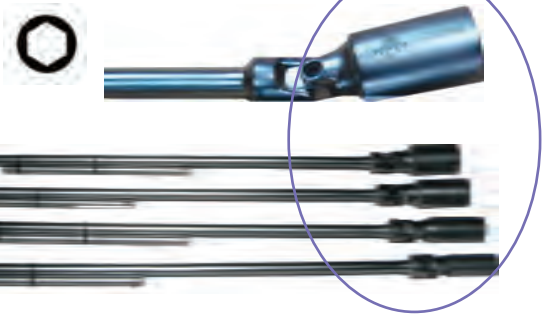

mm 500

213 065 mm 14 - 16 - 18 - 21 4 Pz

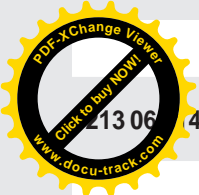

Ricambi - Spare-parts

Chiave singola mm 14 -
Per auto: Renault Twingo-Clio-Kangoo - Citroen 2.0 HDI

213 065 14
Chiave singola mm 16 -
Per auto: VW - Audi - Skoda - Renault - ford - Opel - Bmw - Nissan - Honda - Rover - Mazda -
Per moto: Kawasaki - Yamaha - Honda - Suzuki - Ducati

213 065 16
Chiave singola mm 18 -
Per moto: Kawasaki - Yamaka - Honda - Suzuki - Bmw

213 065 21
Chiave singola mm 21 -
Per macchine: Universale

Chiave magnetica per candele di accensione

Magnetic spark plug wrench



213 070 80 mm - 16 mm

213 071 80 mm - 18 mm

213 072 80 mm - 20.8 mm

Attrezzo rimozione-inserimento capucci candele metallici

Spark-plug caps



213 078 mm 350

213 079 mm 225

Attrezzo articolato avvita candele

Twister spark plug tool



213 080 LunghezzaLenghtLargo - 300 mm

Pinza per cappucci candele con ganasce lunghe

Plier for spark plug connectors



213 082

mm 290

Pinza per sconnettere cappucci candela made in

Plier for spark plug connectors



213 086 Diritta/Straight/Derecha - 225 mm

213 087 Curva/Bent/Acodada - 225 mm

Pinza per estrazione cappucci candela, manici plastificati, filo in acciaio sottile per accesso agevole

Plier for spark plug



213 088 300 mm

Set riparazione filetti candela 14x1.25

Set reparation fillets spark plug 14x1.25



213 090 Set con 1 maschio + 4 boccole

213 091 01 Boccola ricambio - 14x1.25x 9

213 091 02 Boccola ricambio - 14x1.25x11

213 091 03 Boccola ricambio - 14x1.25x13

213 091 04 Boccola ricambio - 14x1.25x19

213 092 Maschio riparazione filetti candele - 14x1.25

Confezione per la riparazione filetti candele deriorati maschio 18x1,5 e 10 boccole in ottone

Set with two males 18x1,5 or Spark plug deteriorated thin



213 096 14x1,25

Ricambi - Spare parts

213 097 Boccola - 14x1,25

213 098 Utensile introduttore

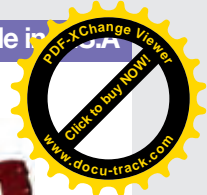

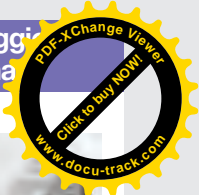
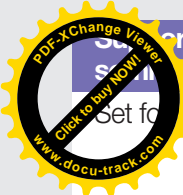

Set per sostituire le valvole su motori benzina
Set for replace engine valves



213 150 universale

Valvola con attacco gonfiagomme per soffiaggio aria per prova tenuta valvole sia sui motori benzina che Diesel

Set for replace engine valves



213 145

Utilizzabile in abbinamento dei nostri prodotti e di un classico gonfiagomme.

Utilizzo con adattatori per Benzina

213 145 01 252 027 01 opp. 252 028 01



Utilizzo con adattatori per Diesel



Per fare la prova tenuta valvole Diesel utilizzare la valvola 213 145 con il nostro kit 252 076

NOTE



Atrezzo pneumatico universale per smontaggio e montaggio valvole su motori Diesel e Benzina
Air operated valve spring compressor

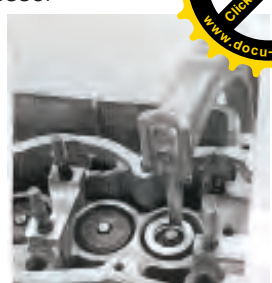

213 15902

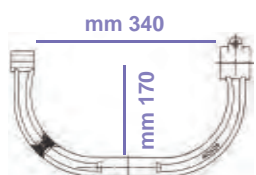
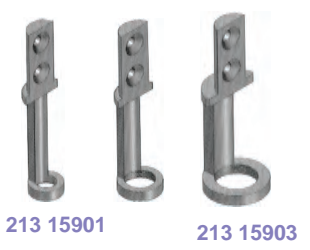
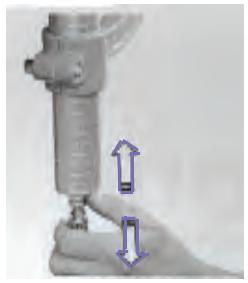

213 159 Spinta: 6 bar = 75Kg / 8 bar = 100Kg
Particolarmente utile per motori con 4 / 5 valvole per cilindro

Ricambi - Spare-parts

- 213 159 01** Estrattore Ø 19.8
- 213 159 02** Estrattore Ø 25.5 con 5 ghiera Ø 24.5-25-27-29-32
- 213 159 03** Estrattore Ø 34 con 3 ghiera Ø 34-41-50

Set estrattore + pressori per valvole
Set for valves



213 161 Kit Pz 4
Da utilizzare con attrezzi pneumatici aventi attacco estrattori a vite

Ricambi - Spare-parts

- 213 161 01** Estrattore con attacco a vite
- 213 161 02** Ghiera Ø 34
- 213 161 03** Ghiera Ø 41
- 213 161 04** Ghiera Ø 50

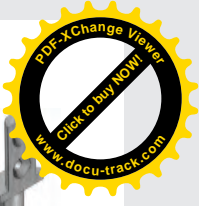
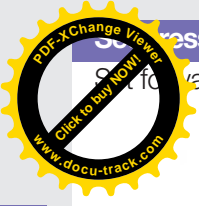

Estrattori per motori 16V

Set for valves



Estrattore con attacco a vite solo per modelli tipo precedente

213 165 Kit Pz 5

Da utilizzare con attrezzi pneumatici aventi attacco campane a vite

Ricambi - Spare-parts

213 165 01 Estrattore con attacco a vite

213 165 02 16 V - Ghiera Ø 20.5

213 165 03 16 V - Ghiera Ø 22

213 165 04 16 V - Ghiera Ø 24

213 165 05 16 V - Ghiera Ø 26

213 165 06 16 V - Ghiera Ø 29

Estrattore per montaggio semiconi valvole. Da utilizzare con attrezzi pneumatici aventi attacco estrattore a vite

Set for valves

Estrattore con attacco a vite solo per modelli tipo precedente



213 166 Audi 5 cilindri

Valvola a corsoio 1/8" con dado fresato

Control valve assembly

Valvola di ricambio per 213 159



213 167

Attrezzo pneumatico universale per smontaggio - montaggio valvole su motori Diesel e Benzina.

Air operated valve spring compressor

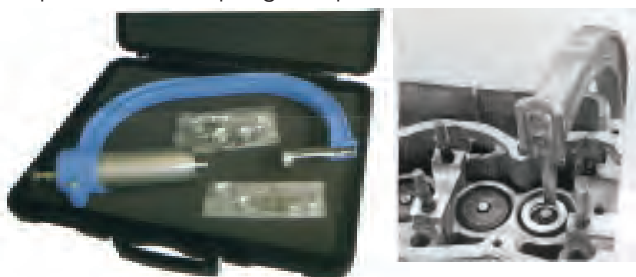

213 15902

213 15901

213 15903

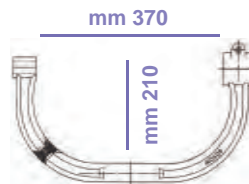

Ghiera

213 169 Spinta: 6 bar = 118Kg / 8 bar = 157Kg

Particolarmente indicato per veicoli commerciali, camion, carter-pillar e motori speciali

Ricambi - Spare-parts

213 159 01 Estrattore Ø 19.8

213 159 02 Estrattore Ø 25.5 con 5 ghiera Ø 24.5-25-27-29-32

213 159 03 Estrattore Ø 34 - con 3 ghiera Ø 34-41-50

Alzavalvole rapido per smontaggio semiconi valvole con diametro mm 25 e mm 30 apertura da mm 45 a mm 145; profondità arco mm 250



213 210

Alzavalvole per smontaggio semiconi valvole motori 6V

Universal valve-spring compressor tool



213 220 Motori: Audi - Bmw - Ford - Opel - Seat - Vw - Hyundai - Toyota - Renault 1.9

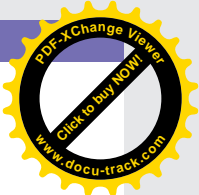
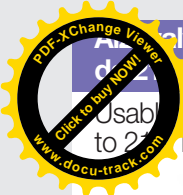

Smerigliavalvole utilizzabile per inseritori automatici
213 239 a 213 118

Valve grinder with automatic wrench from 213101 to 213118



213 239 Apertura mm 180

Alzavalvole universale a sezione piatta

Tool for replacing valves



Apertura Max mm 180

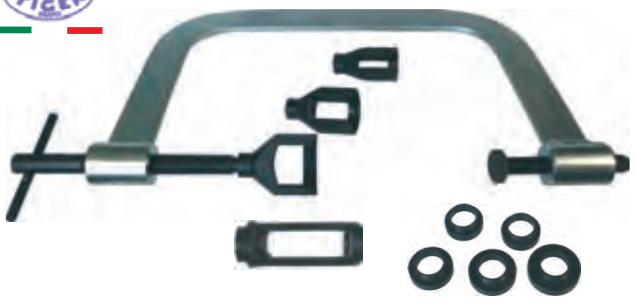

Piattelli **Ghiere x 16V**

| | | |
|----------------|---------------|---------------------------|
| 213 240 | Ø22 / 30 / 38 | ----- |
| 213 244 | Ø22 / 30 / 38 | Ø20,5 / 22 / 24 / 26 / 29 |

Ricambi - Spare parts

- 213 241** Piattello Ø 22
- 213 242** Piattello Ø 30
- 213 243** Piattello Ø 38
- 213 244 01** Campana per 16V
- 213 165 02** Ghiera Ø 20,5 per 16V
- 213 165 03** Ghiera Ø 22 per 16V
- 213 165 04** Ghiera Ø 24 per 16V
- 213 165 05** Ghiera Ø 26 per 16V
- 213 165 06** Ghiera Ø 29 per 16V

Attrezzo per montaggio e smontaggio valvole

Remover and replacer of engine valves



213 255 Ford Fiesta Orion



Smerigliavalvole manuale con 6 pinze

Valve grinder with five adaption



213 260 Ø 5 - 6 - 7 - 8 - 9 - 10 mm

Ricambi - Spare parts

- 213 260 15** Pinza Ø 5 mm
- 213 261** Pinza Ø 6 mm
- 213 262** Pinza Ø 7 mm
- 213 263** Pinza Ø 8 mm
- 213 264** Pinza Ø 9 mm
- 213 265** Pinza Ø 10 mm

Smerigliavalvole manuale con 6 pinze e adattatore per motori 16 valvole

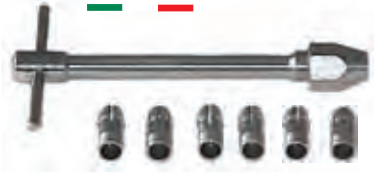

Piani di serraggio per chiave mm 22

213 260 10 Ø 5 - 6 - 7 - 8 - 9 - 10 mm

Composizione

- 213 260 15** Pinza Ø 5 mm
- 213 261** Pinza Ø 6 mm
- 213 262** Pinza Ø 7 mm
- 213 263** Pinza Ø 8 mm
- 213 264** Pinza Ø 9 mm
- 213 265** Pinza Ø 10 mm
- 213 266** Adattatore

Smerigliavalvole pneumatico a ventosa

Pneumatic air valve grinder with suction grip



213 270 Universale

Ricambi - Spare-parts

- 213 271** Ventosa - Suction grip Diam. 20 mm
- 213 272** Ventosa - Suction grip Diam. 30 mm
- 213 273** Ventosa - Suction grip Diam. 40 mm
- 213 274** Snodo / Joint

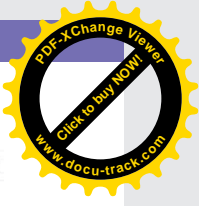
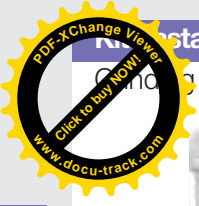

Pasta smeriglio a 3 grane + cromo per lappatura

Grinding paste



213 280 Kit Pz 4

Ricambi - Spare-parts

213 280 01 Pasta grana 400

213 280 02 Pasta grana 600

213 280 03 Pasta grana 800

213 280 04 Pasta Cromo

Smeriglio per valvole, indicato per motori a combustione interna - per una tenuta perfetta delle valvole

Valve grinding paste



213 282 Grana fine - Gr 125

213 283 Grana grossa - Gr 125

Boccola piantamento guide valvole e gommini valvola su Fiat Croma e Alfa 159 - 2.2 Bz

Wrench for valve Fiat Croma & Alfa 159 - 2.2 Bz



213 285

Attrezzo per montaggio gommini valvole

Installer for valves oil seal



213 290 diam. 6 mm

213 291 diam. 7 mm

213 292 diam. 8 mm

213 293 diam. 9 mm

Attrezzo sostegno valvole

Holder for valves



213 294 Fiat 131-126-128-132*242-Ritmo D

Battitoio per montaggio guide valvole

Installer for valves oil seal



213 298 Fiat 131-126-128-132*242-Ritmo D

Battitoio per montaggio guide valvole

Installer for valves oil seal



213 301 Suzuki SJ 413-Maruti-Samurai—Carry

Battitoio per montaggio guide valvole

Installer for valves oil seal



213 302 Suzuki Swift

Introduttore guide valvole motore

Installer for inserting valve guides



213 303 Suzuki Swift

Introduttore guide valvole motore

Installer for inserting valve guides



213 305 Suzuki SJ 410-Carry-Maruti

Pinza estrazione gommini paraolio valvole

Plier for removing valves oil seal



213 310 Made in Germany - 220 mm

Pinza per estrazione gommini paraolio valvole motori 16, 20, 24 Valvole.

Plier for removing valves oil seal on 16, 20, 24 valves motors

Made in Germany

Acciaio
Nichelato



213 311 270 mm

Pinza gommini valvole di piccolo diametro con tagliente

Plier for rubber valves with cutter, little diameter

Made in Germany



213 313 205 mm

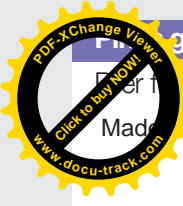

gommini valvole diametro grosso

rubber valves with cutter, big diameter

Made in Germany



213 314 205 mm

Estrattore per smontaggio guide valvole

Puller for valves oil seal



213 315 Mercedes

Confezione di spessori punterie

Set of tappets

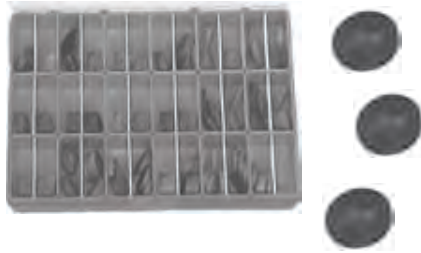

213 320 Diam. 31 mm - Alfa e Fiat Fire ect - 144 pcs - Misure da 3.00-4.75 (ogni 0.05)

Confezione spessori punterie Ø31

Set of tappets Ø31

Ø31
Da mm 2,00
a mm 2,95



213 320 00 Pz 80

Ricambi - Spare-parts



| | | | |
|------------|----------------|------------|----------------|
| 213 320 01 | Ø 31 x mm 2,00 | 213 320 11 | Ø 31 x mm 2,50 |
| 213 320 02 | Ø 31 x mm 2,05 | 213 320 12 | Ø 31 x mm 2,55 |
| 213 320 03 | Ø 31 x mm 2,10 | 213 320 13 | Ø 31 x mm 2,60 |
| 213 320 04 | Ø 31 x mm 2,15 | 213 320 14 | Ø 31 x mm 2,65 |
| 213 320 05 | Ø 31 x mm 2,20 | 213 320 15 | Ø 31 x mm 2,70 |
| 213 320 06 | Ø 31 x mm 2,25 | 213 320 16 | Ø 31 x mm 2,75 |
| 213 320 07 | Ø 31 x mm 2,30 | 213 320 17 | Ø 31 x mm 2,80 |
| 213 320 08 | Ø 31 x mm 2,35 | 213 320 18 | Ø 31 x mm 2,85 |
| 213 320 09 | Ø 31 x mm 2,40 | 213 320 19 | Ø 31 x mm 2,90 |
| 213 320 10 | Ø 31 x mm 2,45 | 213 320 20 | Ø 31 x mm 2,95 |

Spessori sciolti diametro 31 mm per set 213 320

Exchange tappets dia 31 mm for set 213 320



| Codice-Misura Cod.-Measure | Codice-Misura Cod.-Measure | Codice-Misura Cod.-Measure |
|-------------------------------|-------------------------------|-------------------------------|
| 213 321-3,00 mm | 213 333-3,60 mm | 213 345-4,20 mm |
| 213 322-3,05 mm | 213 334-3,65 mm | 213 346-4.25 mm |
| 213 323-3,10 mm | 213 335-3,70 mm | 213 346 01-4.30 mm |
| 213 324-3,15 mm | 213 336-3,75 mm | 213 346 02-4.35 mm |
| 213 325-3,20 mm | 213 337-3,80 mm | 213 346 03-4.40 mm |
| 213 326-3,25 mm | 213 338-3,85 mm | 213 346 04-4.45 mm |
| 213 327-3,30 mm | 213 339-3,90 mm | 213 346 05-4.50 mm |
| 213 328-3,35 mm | 213 340-3,95 mm | 213 346 06-4.55 mm |
| 213 329-3,40 mm | 213 341-4,00 mm | 213 346 07-4.60 mm |
| 213 330-3,45 mm | 213 342-4,05 mm | 213 346 08-4.65 mm |
| 213 331-3,50 mm | 213 343-4,10 mm | 213 346 09-4.70 mm |
| 213 332-3,55 mm | 213 344-4,15 mm | 213 347-4.75 mm |

Confezione di spessori punterie

Set of tappets

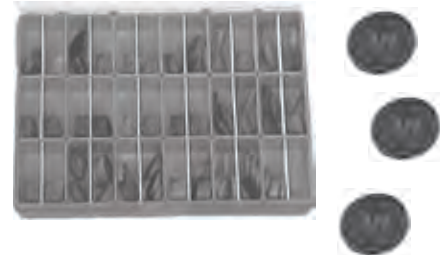

| | |
|---------|---|
| 213 350 | Diam. 40 mm - Fiat D - 136 pcs - Misure da 3.25-4.90 (ogni 0.05) |
| 213 400 | Diam. 33 mm - Fiat Lancia medi - 140 pcs - Misure da 3.00-4.70 (ogni 0.05) |
| 213 450 | Diam. 13,5 mm - Peugeot-Citroen - 104 pcs - Misure da 1.62-3.62 (ogni 0.08) |

Spessori sciolti diametro 40 mm per set 213 350

Exchange tappets dia 40 mm for set 213 350

| Codice-Misura Cod.-Measure | Codice-Misura Cod.-Measure | Codice-Misura Cod.-Measure |
|-------------------------------|-------------------------------|-------------------------------|
| 213 351-3,25 mm | 213 363-3,85 mm | 213 375-4,45 mm |
| 213 352-3,30 mm | 213 364-3,90 mm | 213 376-4,50 mm |
| 213 353-3,35 mm | 213 365-3,95 mm | 213 377-4,55 mm |
| 213 354-3,40 mm | 213 366-4,00 mm | 213 378-4,60 mm |
| 213 355-3,45 mm | 213 367-4,05 mm | 213 379-4,65 mm |
| 213 356-3,50 mm | 213 368-4,10 mm | 213 380-4,70 mm |
| 213 357-3,55 mm | 213 369-4,15 mm | 213 381-4,75 mm |
| 213 358-3,60 mm | 213 370-4,20 mm | 213 382-4,80 mm |
| 213 359-3,65 mm | 213 371-4,25 mm | 213 383-4,85 mm |
| 213 360-3,70 mm | 213 372-4,30 mm | 213 384-4,90 mm |
| 213 361-3,75 mm | 213 373-4,35 mm | |
| 213 362-3,80 mm | 213 374-4,40 mm | |

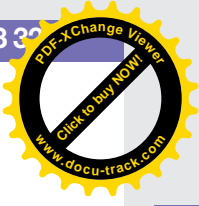

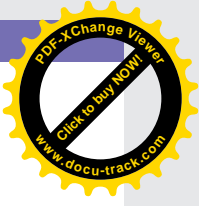
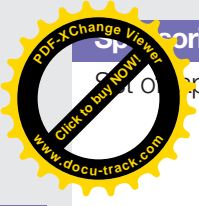

Spessori punterie Ø 33

Set of tappets Ø31



| | | | |
|------------|----------------|------------|----------------|
| 213 400 01 | Ø 33 x mm 2,50 | 213 400 06 | Ø 33 x mm 2,75 |
| 213 400 02 | Ø 33 x mm 2,55 | 213 400 07 | Ø 33 x mm 2,80 |
| 213 400 03 | Ø 33 x mm 2,60 | 213 400 08 | Ø 33 x mm 2,85 |
| 213 400 04 | Ø 33 x mm 2,65 | 213 400 09 | Ø 33 x mm 2,90 |
| 213 400 05 | Ø 33 x mm 2,70 | 213 400 10 | Ø 33 x mm 2,95 |

Spessori sciolti diametro 33 mm per set 213 400

Exchange tappets dia 33 mm for set 213 400

| Codice-Misura Cod.-Measure | Codice-Misura Cod.-Measure | Codice-Misura Cod.-Measure |
|-------------------------------|-------------------------------|-------------------------------|
| 213 401-3,00 mm | 213 415-3,70 mm | 213 429-4.40 mm |
| 213 402-3,05 mm | 213 416-3,75 mm | 213 430-4,45 mm |
| 213 403-3,10 mm | 213 417-3,80 mm | 213 431-4,50 mm |
| 213 404-3,15 mm | 213 418-3,85 mm | 213 432-4,55 mm |
| 213 405-3,20 mm | 213 419-3,90 mm | 213 433-4,60 mm |
| 213 406-3,25 mm | 213 420-3,95 mm | 213 434-4,65 mm |
| 213 407-3,30 mm | 213 421-4,00 mm | 213 435-4,70 mm |
| 213 408-3,35 mm | 213 422-4,05 mm | 213 436-4,75 mm |
| 213 409-3,40 mm | 213 423-4,10 mm | 213 437-4,80 mm |
| 213 410-3,45 mm | 213 424-4,15 mm | 213 438-4,85 mm |
| 213 411-3,50 mm | 213 425-4,20 mm | 213 439-4,90 mm |
| 213 412-3,55 mm | 213 426-4,25 mm | 213 440-4,95 mm |
| 213 413-3,60 mm | 213 427-4,30 mm | 213 441-5.00 mm |
| 213 414-3,65 mm | 213 428-4,35 mm | |

Spessori sciolti diametro 13,5 mm per set 213 450

Exchange tappets dia 13,5 mm for set 213 450

| Codice-Misura Cod.-Measure | Codice-Misura Cod.-Measure | Codice-Misura Cod.-Measure |
|-------------------------------|-------------------------------|-------------------------------|
| 213 451-1,62 mm | 213 460-2,34 mm | 213 469-3,06 mm |
| 213 452-1,70 mm | 213 461-2,42 mm | 213 470-3,14 mm |
| 213 453-1,78 mm | 213 462-2,50 mm | 213 471-3,22 mm |
| 213 454-1,86 mm | 213 463-2,58 mm | 213 472-3,30 mm |
| 213 455-1,94 mm | 213 464-2,66 mm | 213 473-3,38 mm |
| 213 456-2,02 mm | 213 465-2,74 mm | 213 474-3,46 mm |
| 213 457-2,10 mm | 213 466-2,82 mm | 213 475-3,54 mm |
| 213 458-2,18 mm | 213 467-2,90 mm | 213 476-3,62 mm |
| 213 459-2,26 mm | 213 468-2,98 mm | |

Kit di spessori punterie Ø 31,5

Set of tappets Ø 31,5 Set de platitos Ø 31,5



213 480 Renault - 104 pz.

Spessori diametro 31,5 mm

Exchange tappets dia 31,5 mm



| Codice-Misura Cod.-Measure | Codice-Misura Cod.-Measure | Codice-Misura Cod.-Measure |
|-------------------------------|-------------------------------|-------------------------------|
| 213 48101-3,25 mm | 213 48110-3,70 mm | 213 48119-4,15 mm |
| 213 48102-3,30 mm | 213 48111-3,75 mm | 213 48120-4,20 mm |
| 213 48103-3,35 mm | 213 48112-3,80 mm | 213 48121-4,25 mm |
| 213 48104-3,40 mm | 213 48113-3,85 mm | 213 48122-4,30 mm |
| 213 48105-3,45 mm | 213 48114-3,90 mm | 213 48123-4,35 mm |
| 213 48106-3,50 mm | 213 48115-3,95 mm | 213 48124-4,40 mm |
| 213 48107-3,55 mm | 213 48116-4,00 mm | 213 48125-4,45 mm |
| 213 48108-3,60 mm | 213 48117-4,05 mm | 213 48126-4,50 mm |
| 213 48109-3,65 mm | 213 48118-4,10 mm | |

Spessori punterie Ø 28



| | | | |
|---------|----------------|---------|----------------|
| 213 499 | Ø 28 x mm 1,50 | 213 512 | Ø 28 x mm 2,15 |
| 213 500 | Ø 28 x mm 1,55 | 213 513 | Ø 28 x mm 2,20 |
| 213 501 | Ø 28 x mm 1,60 | 213 514 | Ø 28 x mm 2,25 |
| 213 502 | Ø 28 x mm 1,65 | 213 515 | Ø 28 x mm 2,30 |
| 213 503 | Ø 28 x mm 1,70 | 213 516 | Ø 28 x mm 2,35 |
| 213 504 | Ø 28 x mm 1,75 | 213 517 | Ø 28 x mm 2,40 |
| 213 505 | Ø 28 x mm 1,80 | 213 518 | Ø 28 x mm 2,45 |
| 213 506 | Ø 28 x mm 1,85 | 213 519 | Ø 28 x mm 2,50 |
| 213 507 | Ø 28 x mm 1,90 | 213 520 | Ø 28 x mm 2,55 |
| 213 508 | Ø 28 x mm 1,95 | 213 521 | Ø 28 x mm 2,60 |
| 213 509 | Ø 28 x mm 2,00 | 213 522 | Ø 28 x mm 2,65 |
| 213 510 | Ø 28 x mm 2,05 | 213 523 | Ø 28 x mm 2,70 |
| 213 511 | Ø 28 x mm 2,10 | 213 524 | Ø 28 x mm 2,75 |

Spessori punterie Ø28 per Toyota

Single tappets Ø28



| | | | |
|---------|----------------|---------|----------------|
| 213 525 | Ø 28 x mm 2,80 | 213 531 | Ø 28 x mm 3,10 |
| 213 526 | Ø 28 x mm 2,85 | 213 532 | Ø 28 x mm 3,15 |
| 213 527 | Ø 28 x mm 2,90 | 213 533 | Ø 28 x mm 3,20 |
| 213 528 | Ø 28 x mm 2,95 | 213 534 | Ø 28 x mm 3,25 |
| 213 529 | Ø 28 x mm 3,00 | 213 535 | Ø 28 x mm 3,30 |
| 213 530 | Ø 28 x mm 3,05 | | |

Set frese doppia inclinazione con placchette riportate in metallo duro per sedi valvola motori.

Set cutters it doubles inclination and plaquettes brought for centers valve motor



213 540

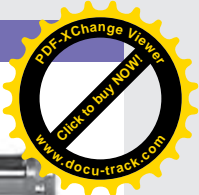

**Supporto portacomparatore per controllo spessore.
e punterie completo di comparatore**

Dial support indicator for tappets measurement with dial

Corsa 10 mm
Ø 58 mm



213 550 Attrezzo completo

215 551 Supporto senza comparatore

Comparatore centesimale

Dial indicator, gauge in 100 ths of a mm



213 552 Diametro 58 mm - Corsa 10 mm

213 554 Diametro 40 mm - Corsa 3 mm

Adattatori opzionali - Optional



510 281 Base magnetica portacomparatore

Comparatore digitale millesimale multifunzionale

Multifunctional electronic digital milesimal



213 553 Display Ø 60 mm

-Campo di misura mm 0 - 10

-Conversione mm / inch

-Azzeramento in ogni posizione

-Spegnimento automatico

-Batteria 1 SR44W

-Astuccio di plastica

-Precisione 0,005 - 0,00025

Supporto comparatore per misura P.M.S

Toos for checking the T.D.C



213 555 Universale - 14x1,25

213 556 Universale - 12x1,25

Supporto comparatore per misura P.M.S

Toos for checking the T.D.C



213 557 Bravo-Brava-Motore 1581 16V - 14x1,25

213 558 Ford - filetto boccola lungo - 14x1,25

Portacomparatore fil. 10x1 per moto

Tool screw 10x1 for motorcycle



213 559 Attrezzo Completo

213 561 01 Boccola 10x1 -

Da usare con: 213 565 / 213 567 / 213 570

Confezione con supporti e portacomparatore per misura P.M.S. e fasatura pompe iniezione Bosch

Set with Dial indicator and tools for checking T.D.C. and be-ginning of delivery of distributor type Bosch pump



213 560 Profondità 8x1-12x1,25-14x1,25 -
Filetto boccola 65-155-225 mm - 14x1,25
filetto lungo - Con comparatore 213 554

Ricambi - Spare parts

213 561 Boccola 8x1

213 56101 Boccola 10x1

213 562 Boccola 12x1,25

213 563 Boccola 14x1,25

213 564 Boccola 14x1,25

213 565 Corpo

213 566 Prolunga 90 mm

213 567 Prolunga 160 mm

213 568 Astina corta

213 569 Astina media

213 570 Astina lunga

213 571 Astina lunga Ford

213 571 01 Astina ex.lunga Ford

213 572 Molla

Staffa portacomparatore in alluminio anodizzato per misurazione PMS con comparatore

Holder for dial indicator for TDC, with dial



213 590 Universale Comp. - 58 mm

213 591 Senza comp.

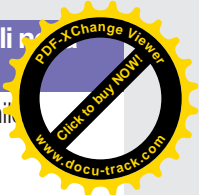
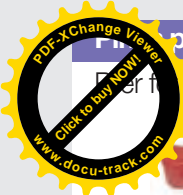

Per estrazione piattelli valvole motore

Per l'estrazione dei piattelli valvole motore



213 600 220 mm

Leva di pressione per inserimento attrezzi di ritegno punterie durante la registrazione

Pressure lever for tappet retainment tools insertion during adjustment



213 602 Universale

Attrezzo ritegno punterie sostituzione piattelli nella registrazione distribuzione

Tools holding tappets for replacing cup plates while adjusting tappets clearance



- 213 610 16 v Alfa Fiat -33-145-Punto 55 - 8,5 mm
- 213 611 Tipo 1,1-2,0 td-Fire-Uno turbo-1930d-ect - 9,5 mm
- 213 612 Tipo 1,4-1,6-1,7d-1,4GT-Punto 90 - 10,5 mm
- 213 613 Croma 2,0 ie-Turbo-Alfa 155-Golf d-td - 11,2 mm
- 213 614 Uno d-Regata d-Punto ds-Fiesta 1,8d - 11,8 mm

Attrezzo ritegno punterie sostituzione piattelli nella registrazione distribuzione

Tools holding tappets for replacing cup plates while adjusting tappets clearance



- 213 626 Regata 1697 D
- 213 627 Uno D 127 D

Attrezzo ritegno punterie sostituzione piattelli nella registrazione distribuzione

Tools holding tappets for replacing cup plates while adjusting tappets clearance



213 629 127 1050- Rustica-Ritmo 60

Attrezzo ritegno punterie sostituzione piattelli nella registrazione distribuzione

Tools holding tappets for replacing cup plates while adjusting tappets clearance



213 630 127 1050- Rustica-Ritmo 60

Attrezzo ritegno punterie sostituzione piattelli nella registrazione distribuzione

Tools holding tappets for replacing cup plates while adjusting tappets clearance



213 631 131D-132D-Argenta D-Daily-Croma TD-DucatoD

Attrezzo ritegno punterie sostituzione piattelli nella registrazione distribuzione

Tools holding tappets for replacing cup plates while adjusting tappets clearance



213 632 Croma TD-Thema TD-Regata 1600

Attrezzo ritegno punterie sostituzione piattelli nella registrazione distribuzione

Tools holding tappets for replacing cup plates while adjusting tappets clearance



213 635 Alfa Sud-33-Arna

Attrezzo ritegno punterie sostituzione piattelli nella registrazione distribuzione

Tools holding tappets for replacing cup plates while adjusting tappets clearance



213 636 Alfa Sud-33-Arna

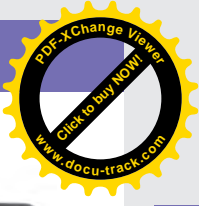
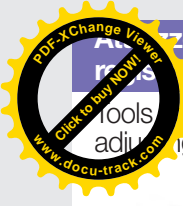

Atrezzo ritegno punterie sostituzione piattelli nella registrazione distribuzione

Tools holding tappets for replacing cup plates while adjusting tappets clearance



213 638 Ford 1600 D

Atrezzo ritegno punterie sostituzione piattelli nella registrazione distribuzione

Tools holding tappets for replacing cup plates while adjusting tappets clearance



213 639 Golf 1.5 -Scirocco

213 640 Golf GTD

Chiave doppia per vite registro bilancieri comando valvole

Wrenches two rocher arm adjusting screw



213 650 10 mm - interno 3 mm

213 651 11 mm - interno 3 mm

213 653 13 mm - interno 3 mm

213 654 14 mm - interno 3 mm

Chiave doppia per vite registro bilancieri comando valvole

Wrenches two rocher arm adjusting screw



213 656 10 mm - interno 3 mm

213 657 11 mm - interno 3 mm

Chiave doppia per vite registro bilancieri comando valvole

Wrenches two rocher arm adjusting screw



213 660 Twingo-Clio Rap-R5-R25 - 10 mm - interno 3 mm

Chiave doppia per vite registro bilancieri comando valvole

Wrenches two rocher arm adjusting screw



213 662 Renault 4-15-18 - 11 mm - Interno 3 mm

213 663 Renault 1400 cc-Volvo 1700 cc - 13 mm - int. lama

Chiave interna registro bilancieri comando valvole

Wrenches two rocher arm adjusting screw



213 665 Golf-Polo mot. 1100 - 7 mm

Coppia chiavi di registro punterie

Twin wrenches for adjusting tappets



213 667 Alfa Sud - 7 mm

Coppia chiavi di registro punterie

Twin wrenches for adjusting tappets



213 670 Opel Rekord D

Set chiavi di registro punterie

Tree wrenches for adjusting tappets



213 671 Mercedes 200 D-250D - 14-30 mm

Chiave registro punterie

Tool tappet adjusting



213 672 Att. 1/2" - Mm 14

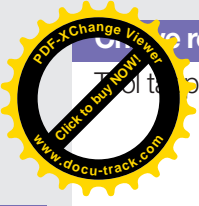

registo punterie

tappets adjusting



- 213 674 Mercedes - 14 mm
- 213 675 Ford - 15 mm
- 213 676 Mercedes - 17 mm
- 213 677 Ford - 19 mm
- 213 678 Volkswagen - 22 mm
- 213 679 23 mm
- 213 679 01 24 mm

Coppia staffe in lamiera per sostegno bicchierini punterie idrauliche

Twin tool holder for hidraulic tappets



- 213 680 Nuova Punto - Lancia Y - Mot.Eng.1200 cc 16v

Estrattore testa cilindri

Puller for extraction head cilynder



- 213 700 Ritmo-Uno-Delta
- 213 701 Bullone

Estrattore testa cilindri

Puller for extraction head cilynder



- 213 702 128-Ritmo
- 213 701 Bullone

Estrattore testa cilindri

Puller for extraction head cilynder

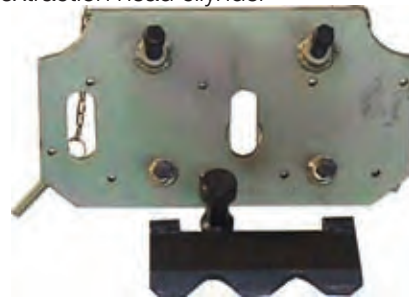

- 213 703 127 D

Estrattore testa cilindri

Puller for extraction head cilynder



- 213 704 Alfa Giuia
- 213 705 Perno

Supporto girevole sostegno testata sulla morsa

Twist holder for head



- 213 710 Alfa Romeo

Supporto testate motori per morsa con orientamento a sfera

Twist holder for head

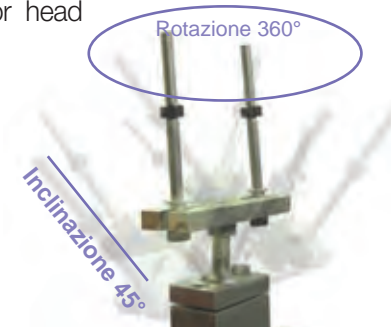

- 213 715 Universale



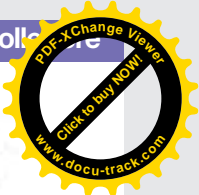
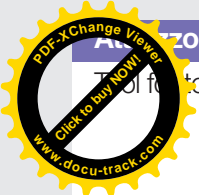

Attrezzo per serraggio angolare dinamometrico

Tool for torque closing



213 722 1/2" - 10°

Attrezzo per serraggio angolare con magnete (Modello economico)

Magnetic tool for torque closing (Economic model)



213 723 1/2" - 1° - mm 450

Attrezzo per serraggio angolare dinamometrico con magnete

Magnetic Tool for torque closing



213 726 1/2" - 1°

213 728 3/4" - 1°

Attrezzo per serraggio angolare dinamometrico con pinza

Tool fo with plier for torque closing



213 730 1/2" - 1°

213 731 3/4" - 1°

Chiave per dadi fissaggio testa cilindri

Wrench socket cylinder head hold down nuts



213 803 Uno-Ritmo 60 1050-Punto 1372Turbo1/2" - 17 mm

213 805 Ritmo 60/65-Regata 1300ES/15001/2" - 19 mm

Chiave per dadi fissaggio testa cilindri lato collettore

Wrench socket for cylinder head hold down nuts collector side



213 806 Ritmo 60/65-Regata 1300ES/15001/2" - 19 mm

Chiave per dadi fissaggio testa cilindri

Wrench socket cylinder head hold down nuts



213 810 127 1050-127-Panda 30/45-242 1/2" - 17 mm

213 811 Ritmo 1° serie-2381/2" - 19 mm

Set per serraggio angolare dadi fissaggio testa cilindri

Set for gauge tightening cylinder head down nuts



213 816 Ritmo D-Punto D-RegataD1/2" - 19/22 mm

Chiave per dadi fissaggio testa cilindri alta

Wrench socket cylinder head hold down nuts



213 820 Renault R4-R5-Citroen AX-BX-ZX-Volvo 940-1,8 D-Honda Civic-Rover 416-Peugeot 106-Ford Fiesta 1,3 .14 mm

Chiave per dadi fissaggio testa cilindri alta

Wrench socket cylinder head hold down nuts



213 821 R4GTL -R5TL/GTL - Scorpio 2,5 D - Clio 1,1 - Opel Corsa 1,4-Vectra - 1/2" - 17 mm

Chiave per dadi fissaggio testa cilindri sottile serraggio manuale

Wrench socket cylinder head hold down nuts



213 822 R4-R5TL - 14 mm

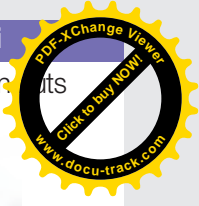
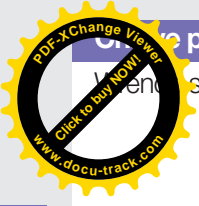

Chiave per dadi esterni fissaggio testa cilindri

Wrench socket for cylinder head external hold down nuts



213 823 Alfa 164 TD 1/2" - 11 mm

Chiave per dadi fissaggio sopra testa cilindri

Wrench socket for cover cylinder head hold down nuts



213 949 Alfa 33 16v - xzn 12 mm

Chiave per dadi fissaggio sopra testa cilindri

Wrench socket for cover cylinder head hold down nuts



213 825 Bmw 520i-520i 24V-320i- 320i 24V-525 i
1/2" Torx E10

213 826 Bmw 520i-520i 24V-320i-320i 24V-525 i
1/2" Torx E12

213 827 Bmw 525TDS-320TDS-730TDS -
1/2" Torx E14

Chiave per dadi fissaggio sopra testa cilindri, coppa olio e nuovi bulloni di serraggio

Wrench socket for cylinder cover head hold down nuts, oil draining plug and other new nuts



213 927 Fiat - esa 6 mm

213 929 Fiat - esa 8 mm

Chiave per dadi fissaggio sopra testa cilindri, coppa olio e nuovi bulloni di serraggio tipo a L

Wrench socket for cylinder cover head hold down nuts, oil draining plug and other new nuts L type



213 937 Fiat - esa 6 mm

213 939 Fiat - esa 8 mm

Chiavi fissaggio dadi testa quadro 1/2"

Wrench socket for cover cylinder head square 1/2"



213 941 XZN 12x140 mm

213 942 VM XZN 14x140 mm

Staffa per sostegno motore cambio

Engine holder



max mm 1570

214 001 Universale

Staffa solleva-motori estensibile

Engine holder extensible



214 005 Sezione tubo: 35 x 35 - 40 x 40

Dati tecnici - Informative

- Coppie di ganci corti - lunghi
 - Coppia di viti di fissaggio con prolunghe.
 - Vite di spinta su coppa olio con tampone di protezione
- Questo attrezzo non crea ingombri durante lo smontaggio del supporto motore, semplificando il lavoro durante il rifacimento della distribuzione o sostituzione frizione

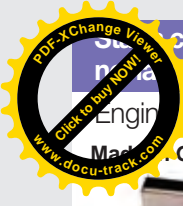

combinata solleva motori, per operare in sicurezza
 di distribuzione o sostituzione frizione

Engine holder extensible
 Made in Germany

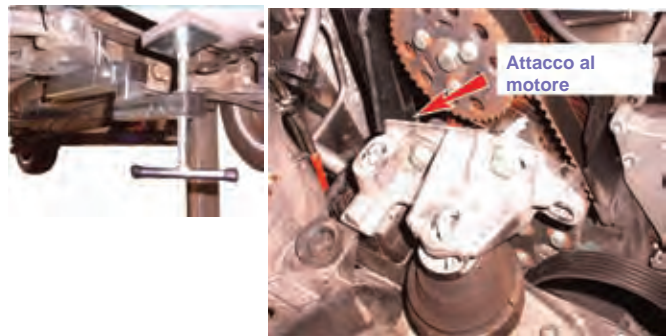

Attacco al motore

214 006 Adatta per motori: Golf 4, Audi A3, VW Sharan, Seat - Alhambra, Ford Galaxy, Golf 5.

Traversa sottoscocca per sostegno motore Auto completa di prolunghe per Furgoni

Engine holder

Brevetto Depositato



214 008 Universale

Dati tecnici - Informative

- Portata max: Kg 200
- Lunghezza: cm 105
- Altezza: cm 10
- Altezza max crick: cm 26
- Peso: Kg 10



Coppie perni per abbassare il telaio durante la lavorazione delle parti inferiori dei motori

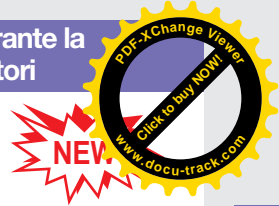

214 009 Per tutte le SMART

Pinza per introdurre i segmenti durante il montaggio dei cilindri con sei fasce

Plier for ring installation during cylinder installation with six bands



214 010 Kit completo in valigetta
 73-80 80-86 86-92 92-98 98-105 105-111 mm

Ricambi - Spare parts

- 214 011** Fascia 73-80 mm
- 214 012** Fascia 80-86 mm
- 214 013** Fascia 86-92 mm
- 214 014** Fascia 92-98 mm
- 214 015** Fascia 98-105 mm
- 214 016** Fascia 105-111 mm
- 214 017** Pinza

Fascia per introdurre i segmenti nei pistoni con frizione

Band for ring installation during cylinder installation



- 214 020** Altezza mm 50 - Diam. 45-75 mm
- 214 022** Altezza mm 80 - Diam. 57-125 mm
- 214 023** Altezza mm 80 - Diam. 90-175 mm

Fascia introduzione segmenti pistoni con cricchetto

Band for piston ring installation with ratchet



214 026 h=160 - Diam.60-175

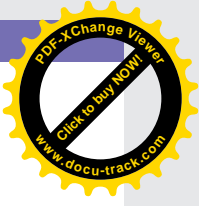
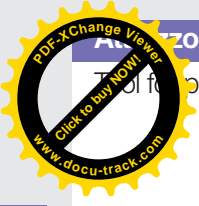

Strumento pulizia sedi fasce elastiche pistoni



214 030 Universale

Pinza montaggio fasce elastiche pistoni



214 031 Universale

Estrattore a leva paraoli



214 032 Universale

Estrattore a leva paraoli



214 033 Universale

Estrattore universale per paraoli, ideale per una rimozione rapida e senza danni



214 034

Attrezzatura montaggio paraolio albero motore



214 035

Dati tecnici - Informative

Motori gruppo VAG / Fiat 1.4 - 1.6, 16V

Attrezzatura montaggio paraolio albero motore



214 035 01

Dati tecnici - Informative

Motori Volkswagen Golf / Touran - Audi A3 A4
1.4i Turbo
1.4 / 1.6 Iniezione diretta
1.9 / 2.1 Sdi / Tdi
2.0 Common rail

Levigatore per cilindri Made in USA



214 036 Diam. 13-57 mm

214 037 Pietra di ricambio

Levigatore per cilindri



214 038 Diam. 20-64 mm

214 039 Pietra di ricambio

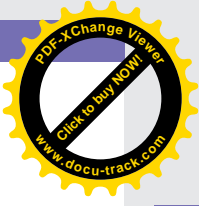

Levitatore per cilindri



| | |
|---------|--------------------|
| 214 040 | Diam. 15-45 mm |
| 214 041 | Pietra di ricambio |
| 214 042 | Diam. 40-140 mm |
| 214 043 | Pietra di ricambio |
| 214 044 | Diam. 55-180 mm |
| 214 045 | Pietra di ricambio |
| 214 046 | Diam. 55-300 mm |
| 214 047 | Pietra di ricambio |

Snodo per levigatore cilindri



| | |
|---------|---------------------------|
| 214 048 | Snodo di ricambio 214 040 |
| 214 049 | Snodo di ricambio 214 042 |
| 214 050 | Snodo di ricambio 214 044 |
| 214 051 | Snodo di ricambio 214 046 |

Levitatore cilindri "FLEX HONE" B C

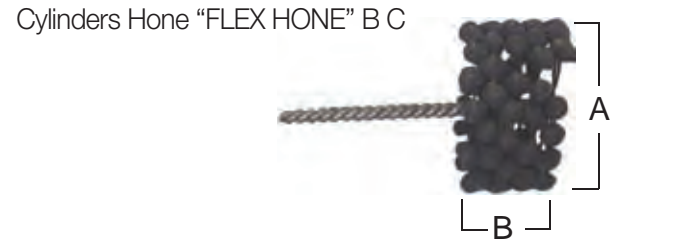

| COD. | L.TOT. | A x B | Ø RANGE |
|---------|--------|-------|---------|
| 214 054 | 120 | 45x45 | 41 ÷ 45 |
| 214 055 | 120 | 64x45 | 57 ÷ 64 |
| 214 056 | 120 | 70x45 | 64 ÷ 70 |
| 214 057 | 120 | 79x45 | 72 ÷ 79 |

NOTE



Levitatore cilindri "FLEX HONE" B C

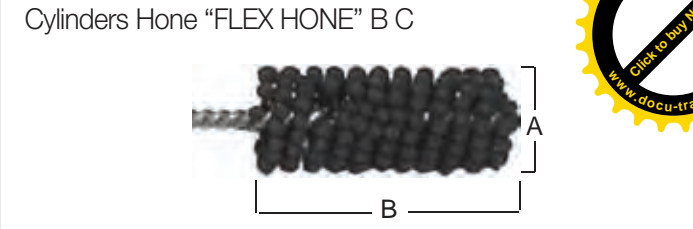

| COD. | L.TOT. | A x B | Ø RANGE |
|------------|--------|----------------|------------|
| 214 060 40 | 152 | 4x20 | 3,5 ÷ 4 |
| 214 060 45 | 152 | 4.5x20 | 4 ÷ 4,5 |
| 214 060 47 | 203 | 4.75x20 | 4,5 ÷ 4,75 |
| 214 060 50 | 152 | 5x38 | 4,75 ÷ 5 |
| 214 060 55 | 203 | 5.5x38 | 5 ÷ 5,5 |
| 214 060 64 | 203 | 6.4x38 - 1/4" | 5,5 ÷ 6,4 |
| 214 060 70 | 203 | 7x57 | 6,4 ÷ 7 |
| 214 060 80 | 203 | 8x57 | 7 ÷ 8 |
| 214 060 90 | 203 | 9x57 | 8 ÷ 9 |
| 214 060 95 | 203 | 9.5x57 - 3/8" | 8,5 ÷ 9,5 |
| 214 061 10 | 203 | 10x57 | 9 ÷ 10 |
| 214 061 11 | 203 | 11x57 | 10 ÷ 11 |
| 214 061 12 | 203 | 12x57 | 11 ÷ 12 |
| 214 061 13 | 203 | 12.7x64 - 1/2" | 12 ÷ 12,7 |
| 214 061 14 | 203 | 14x64 | 12,7 ÷ 14 |
| 214 061 16 | 203 | 16x64 - 5/8" | 14 ÷ 16 |
| 214 061 18 | 203 | 18x64 - 5/8" | 16 ÷ 18 |
| 214 061 19 | 203 | 19x64 - 3/4" | 18 ÷ 19 |
| 214 061 20 | 203 | 20x64 | 19 ÷ 20 |

Levitatore cilindri "FLEX HONE" B C

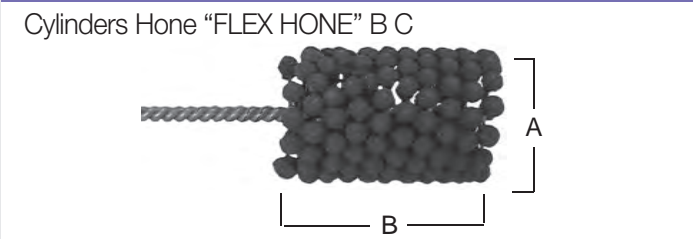

| COD. | L.TOT. | A x B | Ø RANGE |
|-----------|--------|---------|-------------|
| 214 06122 | 203 | 22x76 | 20 ÷ 22 |
| 214 06124 | 203 | 22x76 | 22 ÷ 23,8 |
| 214 06126 | 203 | 25x76 | 23,8 ÷ 25,4 |
| 214 06129 | 203 | 29x76 | 25,4 ÷ 29 |
| 214 06132 | 203 | 32x76 | 29 ÷ 32 |
| 214 06135 | 203 | 35x76 | 32 ÷ 35 |
| 214 06138 | 203 | 38x76 | 35 ÷ 38 |
| 214 06141 | 203 | 41x76 | 38 ÷ 41 |
| 214 06145 | 203 | 45x76 | 41 ÷ 45 |
| 214 06148 | 203 | 47,6x76 | 45 ÷ 48 |
| 214 06151 | 203 | 51x76 | 48 ÷ 51 |
| 214 06154 | 203 | 54x76 | 51 ÷ 54 |
| 214 06157 | 203 | 57x76 | 54 ÷ 57 |
| 214 06160 | 203 | 60x76 | 57 ÷ 60 |
| 214 06164 | 203 | 64x76 | 60 ÷ 64 |
| 214 06167 | 203 | 67x76 | 64 ÷ 67 |
| 214 06170 | 203 | 70x76 | 67 ÷ 70 |
| 214 06173 | 203 | 70x76 | 70 ÷ 73 |
| 214 06176 | 203 | 76x76 | 73 ÷ 76 |

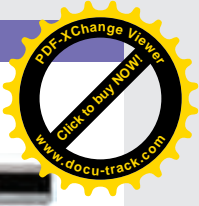

Levitatore cilindri "FLEX HONE" B C

Cylinders Hone "FLEX HONE" B C



| COD. | L.TOT. | A x B | Ø RANGE |
|---------|--------|---------|----------|
| 214 082 | 340 | 83x89 | 76÷ 83 |
| 214 083 | 340 | 89x89 | 83÷ 89 |
| 214 084 | 340 | 95x89 | 89÷ 95 |
| 214 085 | 340 | 105x102 | 95÷ 105 |
| 214 086 | 340 | 118x102 | 105÷ 118 |

Levitatore cilindri "FLEX HONE" B C

Cylinders Hone "FLEX HONE" B C

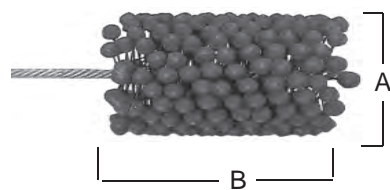

| COD. | L.TOT. | A x B | Ø RANGE |
|---------|--------|---------|----------|
| 214 090 | 343 | 76x127 | 70÷ 76 |
| 214 091 | 343 | 83x127 | 76÷ 83 |
| 214 092 | 343 | 89x127 | 83÷ 88 |
| 214 093 | 343 | 101x152 | 89÷ 101 |
| 214 094 | 343 | 108x152 | 101÷ 108 |
| 214 095 | 343 | 114x152 | 108÷ 114 |
| 214 096 | 343 | 127x152 | 114÷ 127 |
| 214 097 | 343 | 140x152 | 127÷ 140 |

Chiave a T per fascette manicotti ad gancio

Whrench for manifold band



- 214 110 8X110 mm
- 214 112 10X350 mm

Chiave a T per fascette manicotti ad asola

Whrench for manifold band



- 214 114 8X110 mm

Asta rettificata controllo piano testata

Straight edge



- 214 150 520x35x16 mm

Estrattore spinotti bielle

Puller for pin cilynder



- 214 200 Scooter - 520x35x16 mm

Attrezzo montaggio spinotti bielle

Tool for pin cilinder



- 214 201 850-127-A112

Attrezzo collocazione guarnizione albero a camme

Tool for refitting camshaft oil seal



- 214 202 Renault R4-R5

Calettatore per guarnizione coperchio posteriore albero motore

TIntroducer for posterior oil seal on crankshaft



- 214 204 Fiat 127-Panda 45

Calettatore per guarnizione coperchio albero motore

Introducer for posterior oil seal on crankshaft



- 214 205 Ant / Front / Delante - Fiat 132 D-131 D
- 214 206 Post / Rear / Trasero - Fiat 132 D-131 D

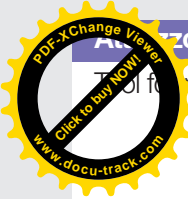

Attrezzo montaggio e smontaggio silent block motore

Tool for mounting and dismantling engine silent blok



214 207 Alfa 164

Attrezzo montaggio e smontaggio silent block motore

Tool for mounting and dismantling engine silent blok



214 208 Thema-Croma

Attrezzo rotazione albero motore durante la manovra del damper

Tool for rotating crankshaft during damper retaining



214 210 Ford 1600 D

Attrezzo ritegno volano durante il fissaggio su albero motore

Flywheel restrainer



214 212

Attrezzo di tenuta vite del damper durante il montaggio paraolio anteriore albero motore

Tool nut damper retainerduring replacement of the crankshaft



214 211 Ford 1600 D

Attrezzo ritegno volano durante il fissaggio su albero motore

Flywheel restrainer



214 213 Fiat 16V

Chiave bloccaggio volano motore

Wrench for hold flywheel



214 217 Ducato benzina - 35 mm

Attrezzo bloccaggio volano motore

Tool for hold flywheel



214 222 Alfa sud-33

Attrezzo blocco volano motori G8T 740 Renault Diesel

Block flyweel tool for Renault G8T 740 motors



214 224

Attrezzo blocco volano motori Opel Astra Diesel

Block flyweel tool for Opel Astra Diesel motors



214 226

Attrezzo blocco volano motori Citroen - Peugeot

Tool block wheel motor Citroen



214 228

Attrezzo blocco volano motori Opel-Isuzu Diesel

Tool block wheel motor Opel Diesel



214 230 Motori 1,5 -1,7

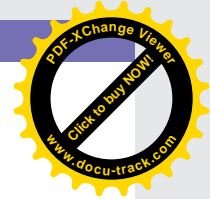

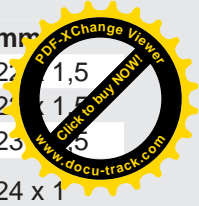
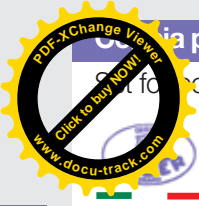

Perni per centraggio volano motore

Bolts suitable to centre flywheel



mm 100

214 234 Chrysler Voyager - Cherokee 2.5 - 2.8

Confezione con liquido rilevatore di perdite da guarnizioni testa o monoblocco

Leak check fluid



214 301 Universale

214 306 liquido di ricambio

Kit rilevatore perdite dalla guarnizione testata

Leak - Check

Per motori Benzina e Diesel



214 305 Kit completo di liquido

214 306 Liquido di ricambio

Estrattori volano motore filetto esterno

Puller fly whell



| | Indicato per: | mm |
|-------------------|------------------------|-----------|
| 214 310 | Cev - Gilera - GSA | 16 x 1 |
| 214 311 | Ciao - SI - Bravo - PK | 17 x 1 |
| 214 312 | | 18 x 1 |
| 214 312 01 | CPI 50cc 2T - 6 marce | 18 x 1 SX |
| 214 313 | Yamaha cross 125 / 250 | 18 x 1,5 |
| 214 314 | Ducati elettronico | 19 x 1 |
| 214 315 | Peugeot | 20 x 1 |
| 214 316 | | 21 x 1,25 |
| 214 317 | | 21 x 1,5 |
| 214 318 | Pedivelle ciclo | 22 x 1 |

Indicato per:

| | | |
|-------------------|---|-----------|
| 214 319 | Bosch - Ducati - Motoplatt | 24 x 1,5 |
| 214 319 01 | Bmw dal2010 - Nippoden 50 | 24 x 1,5 |
| 214 320 | | 25 x 1,5 |
| 214 321 | Yamaha - MBK - Peugeot - Honda - Kimco 50cc | 24 x 1 |
| 214 321 01 | Vespa PK | 24 x 1 |
| 214 322 | ISCRA motori - Morini 50cc | 24 x 1,5 |
| 214 323 | | 26 x 1 |
| 214 324 | Kokusan - Mitsuba - Piaggio - Vespa - Gilera - Aprilia - Peugeot | 26 x 1,25 |
| 214 325 | Bosch - Motoplatt - SEM - Ducati | 26 x 1,5 |
| 214 326 | | 27 x 1 SX |
| 214 327 | Kokusan | 27 x 1 |
| 214 328 | Motoplatt - Ducati | 27 x 1,25 |
| 214 329 | | 27 x 1,5 |
| 214 330 | Motoplatt - Piaggio - Gilera 50, 125, 150, 200 2t - Gilera 125, 150, 180 4t | 28 x 1 |
| 214 331 | | 28 x 1,25 |
| 214 332 | | 28 x 1,5 |
| 214 333 | Motoplatt | 30 x 1,5 |
| 214 334 | | 32 x 1,25 |
| 214 335 | Motoplatt - Fensa | 33 x 1,5 |
| 214 336 | | 38 x 1,5 |

Estrattori volano motore filetto interno

Puller fly whell



| | Indicato per: | mm |
|-------------------|--|-----------|
| 214 339 | | 24 x 1 |
| 214 339 01 | Honda CRF250-450 4t / Cross / Enduro | 24 x 1,5 |
| 214 340 | KTM 125, 250 2t | 26 x 1 |
| 214 342 | Honda cross 125,250 2t - Honda motard TRX 250, 450 4t - Kawasaki KRX, KLX - Suzuki DRZ | 28 x 1 |
| 214 344 | | 29 x 1,25 |
| 214 345 | Yamaha WR / YZ 250F | 30 x 1 |
| 214 345 01 | Kaw. KX / Suz. RM / Honda CRF 250-450 4t | 30 x 1,25 |
| 214 346 | Honda cross 125,150, 250 4t | 30 x 1,5 |
| 214 346 01 | Puleggia avv. Honda 125-150 4t | 32 x 1,5 |
| 214 347 | Honda 300 4t - KTM - Suzuki-Yamaha Wr - YZ 450 F | 33 x 1,5 |
| 214 347 01 | Volano Ducati / Piaggio 250-400-500 4t | 35 x 1 |
| 214 348 | Bosch - Rcpil - Rotax 125, 250 - Yamaha (vecchi modelli) | 35 x 1,5 |
| 214 350 | Kawasaki Klx - KSF - Suzuki Dr - Burgam - Bombardier - Aprilia | 38 x 1,5 |

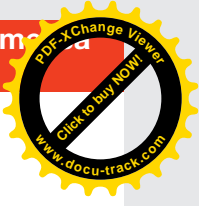
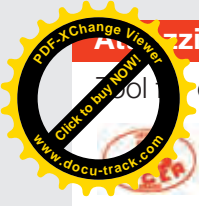

Attrezzi per messa in fase alberi a camme

Camshaft regulation



- 215 001 Bravo-Brava-Delta-Y10 Mot. Eng.1400 cc 12V
- 215 002 Lancia K anno 97 in poi 5 cil. Bravo gamma 98 Marea gamma 99 Alfa 155 Vis 2000 20 v
- 215 003 Lancia 2.4 - Alfa 3.0 V6 24 V
- 215 004 Lancia motore VIS 4 cil - Lancia K 2.4 20V
- 215 005 Lancia K 5 cil anno 96 2000 20 v
- 215 006 Bravo Brava Marea Lancia 115 cv senza variatore di fase 1800 16 v
- 215 008 Coupè Barchetta Lancia 130 Cv con variatore di fase 1800 16 v
- 215 009 Punto HGT - Motore con variatore di fase e collettore a geometria variabile 130 Cv 1800 16 v
- 215 010 Bravo Brava Marea 2000 20v
- 215 011 Alfa motore STEP A 1600 16v
- 215 012 Alfa 1.4/1.6 16v - Alfa 147 1.6 16V
- 215 013 Alfa 1.8/2.0 16V - Alfa 147 2.0 16V
- 215 014 Alfa 147 1.6 16V 105 Cv
- 215 015 Alfa 2.0 JTS
- 215 016 Alfa - Lancia 3.2cc

Attrezzo bloccaggio albero motore per messa in fase albero a camme

Kit of tools for camshaft regulation



215 025 Bravo-Brava-Delta-Y10 - Mot.Eng.1400 cc 12V

Coppia di attrezzi per bloccaggio in fase albero a camme

Twin tool holder for camshaft



215 026 Nuova Punto - Lancia Y - Mot.Eng.1200 cc 16v

Coppia di tastatori per bilanciamento pistoni durante la messa in fase albero a camme

Twin tool for regulation piston stroke



215 027 Nuova Punto - Lancia Y - Mot.Eng.1200 cc 16v

Blocchetto fissaggio puleggia distribuzione durante il serraggio della vite centrale della puleggia



215 02701 Mot.1400 cc 16v EVO2

Attrezzo blocco albero motore Fiat

Wrench for Block arbor Fiat motors



215 028 FIRE

215 029 Punto 188

Coppia attrezzi messa in fase alberi camme

Tools for camshaft regulation



215 030 Bravo-Brava-Stilo- Multipla 1581 16v

Cassetta attrezzi messa in fase albero a camme

Kit of tools for camshaft regulation



215 021 14 motori - Motor/engine Fiat - Alfa - Lancia
Composizione: 215 001 - 002 - 003 - 004 - 005 - 006 - 008 - 009 - 010 - 011 - 012 - 013 - 014 - 015

Cassetta attrezzi messa in fase albero a camme

Kit of tools for camshaft regulation



215 022 13 Motori - Fiat - Alfa - Lancia
Composizione: 215 001 - 002 - 004 - 005 - 006 - 008 - 009 - 010 - 011 - 012 - 013 - 014 - 015

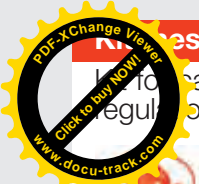

Messa in fase Motori Fiat 1.6 16V

Tool for camshaft regulation



215 031

Ricambi - Spare parts

213 557 Supporto PMS

215 030 Coppia attrezzo fase

215 570 Chiave tendicinghiaFil. mm 8

PER STILO E MULTIPLA BIPOWER VEDERE 215 571 E 215 57101

Confezione messa in fase alberi a camme, distribuzione e sostegno bicchierini punterie idraulichee

Tool for camshaft regulation



215 033 Nuova Punto - Lancia Y - Mot.Eng.1200 cc 16v

Ricambi - Spare parts

213 680 Lamiere supporto bicchierini

215 026 Perni blocco camme

215 027 Tastatori bilancio pistoni

215 610 Chiave tendicinghia

Kit messa in fase cinghia di distribuzione motori Fiat 1.2 16V e Motori 1.4 16V EVO 2

Tool for camshaft regulation



codice

215 034



Ricambi - Spare-parts

215 026 Coppia di attrezzi bloccaggio alberi a camme



215 027 Coppia di tastatori per bilanciamento pistoni



215 027 01 Attrezzo blocco puleggia distribuzione 1.4 16V



215 610 Chiave a 2 denti per rotazione tendicinghia della distribuzione



213 680 Coppia di lamierini di sostegno delle punterie idrauliche

Confezione per messa in fase motore

Tool for camshaft regulation



215 035 Bravo-Brava-Delta-Y10 - Mot.Eng.1400 cc 12V

Ricambi - Spare parts

215 025 Piastra blocco albero motore

215 001 Cavallotto blocco albero a camme

Attrezzo fase albero distribuzione motori Fiat FIRE

Wrench for block camshaft Fiat FIRE motors



215 038 Per motori dal n. 6800001 a 7000000

215 038 01 Per motori con n. superiore a 2533528

Kit messa in fase motori 2.2 Benzina

Kit for camshaft regulation engine 2.2 gasoline



215 039 Alfa 159 - Fiat Nuova Croma

Ricambi - Spare-parts



215 039 01 Staffa blocco alberi a camme



215 039 02 Leva puleggia albero motore



215 039 03 Blocco alberi controrotanti

Attrezzo blocco pompa acqua per motori Fiat 2.2 Benzina

Block pulley for water pump - Engine 2.2 gasoline



215 039 04 Alfa 159 - Fiat Nuova Croma

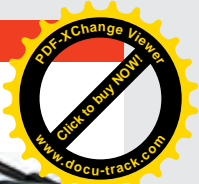

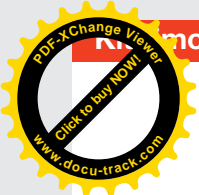

Smorzamento pompa acqua VW Tuareg 2.5 D



215 039 10 Motori BAC-BLK-BPD-BPE

Kit per lavoro su organi distribuzione motore



215 040 Fiat Barchetta-Coupè - Kit completo

Ricambi - Spare-parts

215 041 particolare 1 - estrattore

215 042 particolare 2 - rotazione albero

215 043 particolare 3 - smontaggio variatore

215 044 particolare 4 - tenditore

Kit attrezzi fase SUV DR5

Timing tool set for DR5 SUV

codice

215 045



Ricambi - Spare-parts

215 045 01 Piastra blocco camme

215 045 02 Perno blocco motore

Kit per messa in fase motori F1A - F1C IVECO Daily & Ducato 2.3 - 2.8 - 3.0cc

Wrench test distribucion IVECO Daily and Ducato F1A-F1C motors



215 046 Kit completo

Ricambi - Spare-parts

215 046 01 Asta blocco motore

215 046 02 Perni blocco camme

Kit messa in fase Alfa Mito 1.4 - 16V

Engine timing tool
Alfa mito 1.4 - 16V



215 047 in valigetta

Motori: 199 A 6000 / 199 A 8000 / 955 A 8000

Ricambi - Spare-parts



215 026 Coppia di attrezzi bloccaggio alberi a camme



215 027 01 Attrezzo blocco puleggia distribuzione



215 158 01 Staffa blocco albero a motore



215 610 Attrezzo rotazione tenditore

Kit messa in fase motore 1.9 JTD 16V

Engine timing tool set 1.9 JTD 16V



215 048 Alfa 159 - Fiat Nuova Croma

Ricambi - Spare-parts



215 048 01 Staffa blocco albero motore



215 048 03 Staffa blocco volano



215 076 00 Perno blocco albero a camme

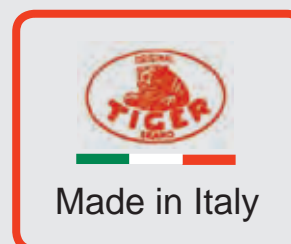

www.afasupport.it

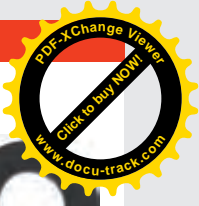

Messa in fase Fiat Croma - Alfa 159 1.8 16V

Camshaft regulation Fiat Croma-Alfa 159 1.8 16V



215 491
Con riferimento
marcato al laser
per facilitarne
l'utilizzo

215 049 Kit in valigetta

Ricambi - Spare-parts

215 049 01 Attrezzo ferma volano

215 049 02 Staffa blocco alberi a camme

215 491 Attrezzi blocco pulegge alberi a camme

Settore graduato messa in fase motore

Jig for ignition timing



215 050 Universale - Diam. 130 mm

215 051 Universale - Diam. 240 mm

Spina per messa in fase albero motore

Retainer for flywheel



215 053 Citroen 1.9 D

Perni per messa in fase puleggia iniezione

Nuts for retain injection pump



215 054 Citroen 1.9 D

Attrezzo mantenimento P.M.S. sul 1° cil.

Retainer for T.D.C. on first cylinder



215 061 Mot. Fiat 1697 D-1929 D

215 062 Mot. 1910 D TD - 1910 JTD - 2387 TD-JTD

Kit messa in fase cinghia distribuzione Multiair 1.4

Timing tool for Fiat Multiair 1.4



215 068

Ricambi - Spare-parts

215 068 01 Piastra blocco albero a camme

215 158 01 Staffa albero motore

NOTE



Blank lined area for notes.

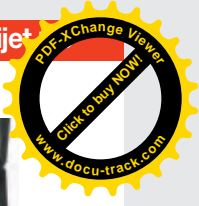
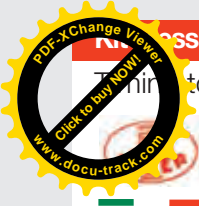

Messa in fase cinghia distribuzione Twin Air



215 069 in valigetta

Ricambi - Spare-parts

- 215 069 01 Piastra albero a camme
- 215 069 02 Perno blocco albero motore
- 215 069 03 Perno fasatura puleggia

Confezione per messa in fase motore



215 070 Motori DIESEL 1697D - TD 1929 D - TD 1910D - TD 1910 JTD - 2387 TD JTD

COMPOSIZIONE

- 215 061 Mot. Fiat 1697 D-1929 D
- 215 062 Mot. 1910 D TD - 1910 JTD - 2387 TD-JTD
- 215 071 Mot. Fiat 1697 D-TD 43.5°
- 215 072 Mot. Fiat 1929 D 42.5°
- 215 073 Mot. Fiat 1929 TD 41.5°



Confezione per messa in fase motori Fiat Multijet

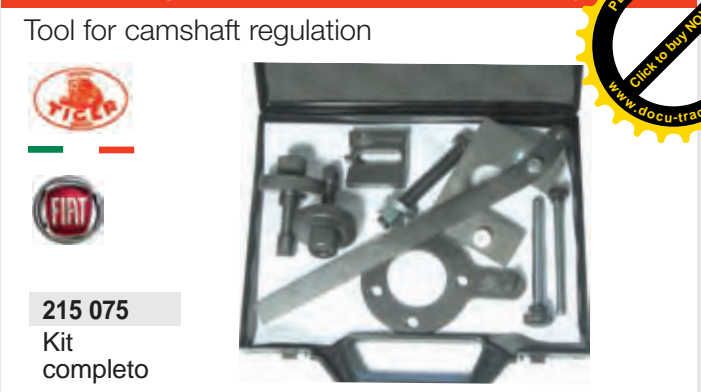

215 075 Kit completo

Ricambi - Spare-parts

- 215 075 01 Coppia blocco alberi a camme
- 215 075 02 Blocco albero motore perno 10 mm
- 215 075 03 Tendicinghia
- 215 075 04 Blocco volano
- 215 075 05 Perno Ø8 blocco volano
- 215 139 03 Perno Ø6 blocco volano

Kit messa in fase motori 1.9 cc Multijet



215 076 In blister

Ricambi - Spare-parts

- 215 062
- 215 075 04
- 215 076 01
- 215 139 03

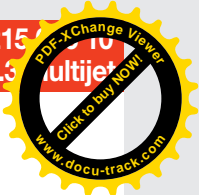
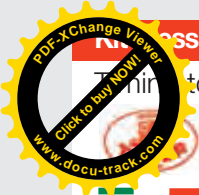

Kit messa in fase motori 1.3 e 1.9cc Multijet

Timing tool for camshaft regulation



215 076 10 In valigetta

Ricambi - Spare-parts



215 062 Staffa blocco albero motore



215 075 01 Coppia blocco alberi a camme



215 075 02 Blocco albero motore (perno mm10)



215 075 03 Tendicinghia



215 075 04 Blocco volano

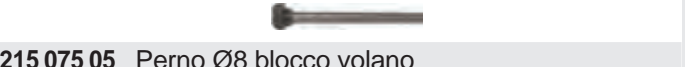

215 075 05 Perno Ø8 blocco volano

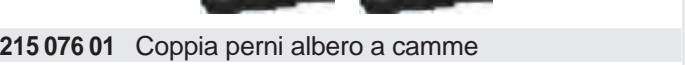

215 076 01 Coppia perni albero a camme



215 139 03 Perno Ø6 blocco volano

Kit messa in fase motori 1.6 cc Multijet

Engine timing tool set 1.6 Multijet

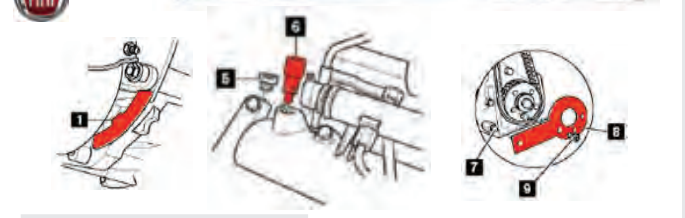

215 076 50 In valigetta

Ricambi - Spare-parts



215 048 01 Staffa blocco albero motore



215 076 00 Perno blocco albero a camme



215 076 55 Staffa blocco volano

Adattatori opzionali per nostri art: 215 075 & 215 076 da utilizzare su versioni particolari di motori 1.3 Multijet



215 076 56 Perno blocco volano mm 9 x100



215 076 57 Staffa blocco albero motore

Kit messa in fase motori VW Polo 1.2

Timing tools VW - Polo 1.2



215 077 3 Cilindri / 12 Valvole in blister

Ricambi - Spare-parts



215 077 01 Coppia attrezzi alberi a camme

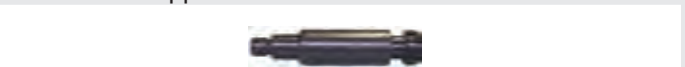

215 077 02 Perno blocco albero motore

Kit messa in fase motori VW Polo 1.2

Timing tools VW - Polo 1.2



215 078 3 Cilindri / 6 - 12 Valvole - Kit in valigetta

Attrezzatura fasatura pompe iniezione

Tool for injection pump regulation



215 079 Pompe Lucas su Kangoo, Doblò e Mercedes

Attrezzatura mantenimento fase pompa iniezione

Tool for checking the delivery injection pump



215 080 Mercedes 190 D-C 220 D

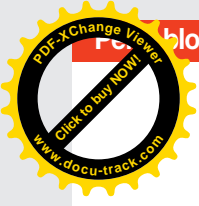

Blocco alberi a camme Mercedes Classe A



215 081

Blocco albero a canne

Clamp for stroke checking



215 082 BMW 316 - 318 -Z3 - 750 - 850 - Motori 16 4E 2 (E30-E36) / 18 4E 2 (E28-E36) / 19 4E 2 (M43) - 50 12A (M70) / 56 12 1 (S70) / 54 12 1 - 54 12 2 (M73)

Blocco albero a canne

Clamp for stroke checking



215 083 BMW 318 TDS - 325 TDS- 525 TD-TDS - 725 TDS - Motori 17 4T 1 (E36) / 25 6T 1 (E39-E34-E38)

215 084 BMW TD 524 vecchio modello

Kit fasatura motore BMW tutti i modelli benzina doppio albero a camme con testata singola

Kit for stroke cheking BMW duoble camshaft



215 085 BMW 318-320-323-328-520-523-525-528-728-Z3 - Motori 18 4S 1 / 19 4S 1 / 20 6S 2 / 25 6S 1 / 25 6S 2 / 20 6S 3 / 25 6S 3 / 28 6S 1 / 20 6S 4 / 25 6S 4 / 28 6S 4 / 28 6S 2.

Attrezzo fasatura contralberi motore BMW 318 IS

Kit for phase contrarbor motor BMW 318 IS



215 085 01

Kit in valigetta per fasatura motore BMW

Kit for phase motor BMW

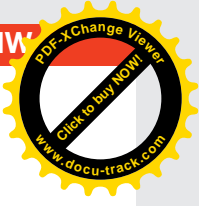

215 085 10 BMW 316-318-320-323-325-520-523-525-528-725-728-Z3 (Per motori vedi 215 082 e 215 085)

Kit messa in fase pompa iniezione e alberi controrotanti per BMW N 47 (utilizzabile solo in abbinamento a nostro 21508515)

Timing tool for BMW N 47



215 085 12 In blister

Kit messa in fase motori BMW 2.0 N47 - N47s (DV20A / B)

Engine timing tool set 2.0 BMW



215 085 15 In valigetta

NOTE



Blank lines for notes

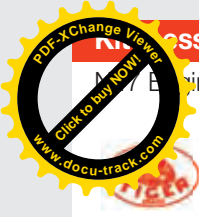

Stessa in fase motori BMW 2.0

BMW Engine timing tool set 2.0 BMW



215 085 19 215 085 12 + 215 085 15 - In valigetta

Ricambi - Spare-parts



215 085 13 Fase pompa iniezione



215 085 14 Fase alberi contrrotanti



215 085 16 Piastra blocco alberi a canne



215 085 17 Chiave rotazione motore



215 086 01 Perno blocco albero motore

Per modelli:

| | | | | |
|-----------------|---------|---|-----------------|---------|
| 118d. E81-87 | (06-09) | / | 120d. E81-82-87 | (06-09) |
| 123d. E81-82-87 | (07-09) | / | 318d. E90-91 | (07-09) |
| 320d. E90-91-92 | (05-09) | / | 520.d E60-61 | (06-08) |
| x3 2.0d. E8 | (07-09) | | | |

Kit messa in fase motori Bmw M60 & M62

Kit for Bmw engine models M60 & M62



215 085 20 in valigetta

Staffa riscontro fase motori BMW M47 - M57

Wrench test distribution BMW M47 - M57 motors

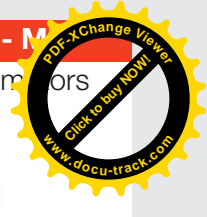

215 086 Kit completo x BMW 320d/330d/530d/730d - Motori 20 4d 1 (M47) / 30 6d 1 (M57)

Ricambi - Spare-parts

215 08601 Perno blocco volano

Estrattore pompa iniezione BMW M47 - M57

Tool for injection pump BMW M47 - M57



215 087 10 Kit completo - 215 087+215 087 01+215 087 02

Ricambi - Spare-parts

215 087 Estrattore/Puller/Extractor

215 087 01 Ghiera di supporto estrattore - 42x1.5

215 087 02 Ghiera di supporto estrattore - 40x1.5

Estrattore pompa iniezione CP4

Tool for injection pump CP4



215 087 50 BMW serie 1 n 47

Estrattore per pompa iniezione BMW con ingranaggio avente filetto maschio

Tool for injection pump BMW



215 088

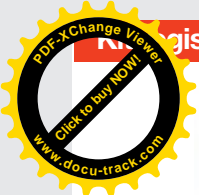

Kit registro fasatura motori BMW M52 - M54 - M56



- 215 089 Kit Completo - Motori 20 6S 4 / 25 6S 4 / 28 6S 4 / 28 6S 2
- 215 089 01 Piastra alluminio per allineamento pulegge
- 215 089 02 Piastra teflon allineamento ruota fonica.

Kit attrezzi per fasatura distribuzione motori BMW N42 - N46 - N46T

Timing tool set for Professional Engine Repair



215 089 10

Modelli Vetture BMW:

- E87 118i / 120i - Motore N46
- E46 316i / 316ti / 318i / 318ti - Motore N42
- E46 316i/316ti/318ti- Motore N42
- E90 / E91 318i / 320i - Motore N46
- E85 Z4 , 2,0l - Motore N46

Kit registro fasatura motori benzina) Bmw N62 / N73

BMW input / output camshaft alignment tool set



215 089 20
in valigetta

Kit registro fasatura motori benzina Bmw N52

Engine timing tool set for repair BMW N52



215 089 30
in valigetta

Kit messa in fase Bmw N51 / N52 / N53 / N54

Engine timing tool set for N51 / N52 / N53 / N54

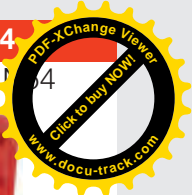

215 089 40
in valigetta



Per modelli:

- 128i - E82 (07-08), 130i - E81/E87 (05-08), 135is. E82 (07-08), 323i - E90/91/92/93 (04-08), 325i / xi - 330i / xi - 335i / xi - 523i / Li - E60/61 (04-08) X3 - 2.5 / 3.0 E83 (06-08), Li / 525i / xi - E60/61 (06-08), 630i - E60/61 (04-08), 528i / Li / xi - E60/61 (06-08), 530i / Li / xi - E60/61 - (05/08), 535i / xi - E63/64 (04-08), 730i / Li - E65/66 (04-08), X5 3.0 - E70 (06-08), Z4 2.5 / 3.0 - E85/86 (05-08) - 328i E90/91/92/93 (04-08) xi

Kit messa in fase Bmw N40 / N45 (T)

Kit messa in fase Bmw N40 / N45 (T)



215 089 50
in valigetta



Per modelli:

- 1 serie 116 E81 / E87 - 3 serie 316i E46 / E90 - 316 Ci E46 316 Ti E46

Staffa ritegno puleggia distribuzione per messa in fase



215 091 Audi D

Staffa ritegno puleggia distribuzione per messa in fase



215 092 Fiesta D

Perno di riscontro fase precamera

Pin for stroke checking



215 105 Mot. 1930 D

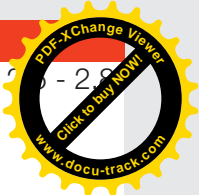

Attrezzo per smontaggio e rimontaggio pompa motori Ford Duratorq 2.0, 2.2 e 2.4

Set for assembly / disassembly Vp pump on engine Ford Duratorq 2.0, 2.2, 2.4



Attrezzo smontaggio pompa iniezione dall'ingranaggio di comando

Tool for dismounting Injection pump



215 110 Ford 1600 D

Staffa ritegno puleggia distribuzione per messa in fase

Timing tool for camshaft regulation



215 112 Alfa 90 alfetta Motronic

Chiave ghiera fissaggio ingranaggio distribuzione

Wrench for distribution nut



215 113 Alfa 90 Alfetta Motronic 55 mm

Chiave per smontaggio variatore di fase albero distribuzione



215 114 Alfa 90 Alfetta Motronic 58 x 52 x 4,5

Chiave per variatore fase albero distribuzione

Wrench for valve timing device on camshaft



215 115 Alfa 90 Alfetta Motronic 42 x 36 x 4,5

Kit messa in fase motori Chrysler 2.5 - 2.8

Kit for camshaft regulation Chrysler motors



215 117 Kit completo Voyager - Cherokee - Pz 4

Ricambi - Spare-parts

- 215 117 01 Spina singola
- 215 117 02 Spina singola
- 215 117 03 Spina singola
- 215 117 04 Spina singola

Estrattore per puleggia ventola

Puller for fan coil pulley



215 118 Alfa 164 2.5 Td

Kit per la messa in fase motori Citroen - Peugeot

Kit camshaft regulation engine Citroen - Peugeot

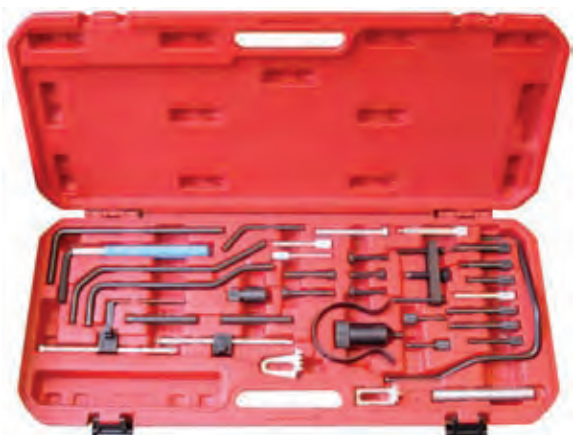

215 119

CITROEN: AX - Berlingo - BX - C5 - C15 - C25 - Dispac - Evasion - Jumper - Jumi - Relay - Saxo - Synergie - Visa - Xara - Xantia - Xm - XJR - ZX

PEUGEOT: 106 - 205 - 306 - 405 - 406 - 605 - 806 - J5 - Boxer - Expert - Partner - Solara - Talbot Express - Talbot Horizon

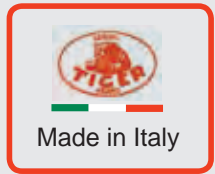

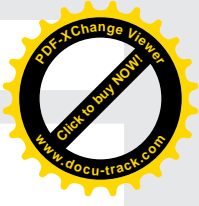

Messa in fase motori Citroen - Peugeot

Timing tool set - Citroen - Peugeot



215 119 01 Motori 1.4 - 1.6 HDI - 2.0 16V Bz

Confezione per messa in fase motore

Tool for camshaft regulation

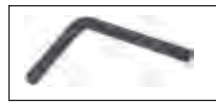

Particolare Spina mm 6

215 120 Citroen-Peugeot-Renault-Rover
Ricambi contenuti

Ricambi - Spare-parts

- 215 121 Attrezzo fermo / Pin / Eje 7.5 - 8 mm
- 215 121 01 Attrezzo fermo / Pin / Eje 6 mm
- 215 122 Coppia spine / Twin pins / Doble eje 6.6 mm
- 215 123 Coppia viti /Twin bolts /Doble tuercas 6x1 - 55 mm
- 215 124 Tre viti / Tree bolts / Tres tuercas 8x1.25 - 50 mm

Kit messa in fase motori Audi - Ford - Vw - Volvo e motori Zetec

Tool for camshaft regulation engine Audi - Ford - Vw - Volvo & motori Zetec



Novità inclusa



215 125 Questa composizione sostituisce quella precedente

Ricambi - Spare-parts

- 215 100 Spina Golf Diesel Ø 15.4
- 215 101 Spina Ford Diesel Ø 6
- 215 102 Spina Ford Zetec 1.2 - 1.4 - 1.6 - Ø 5

215 104 Spina Ford 1.8 - 2.0 16V



215 126 Staffa di fermo albero a camme



215 127 Coppia di spine Ø 6



215 128 Spina Ø 8.25



215 129 Spina Ø 9.5



215 130 Spina Ø 12.7



215 131 01 Spina Ford blocco - volano Ø 9
215 131 02 Spina Ford blocco - volano Ø 13



215 133 Staffa di fermo albero a camme



510 414 Spessimetri 0.05 - 1.00 - 20 Lame



Coppia di spine per blocco volano motori Ford 1.4 TDCi - 2.0 - 2.4

Pin couple for fly-wheel block engine Ford



215 131 Spina Ø 9 + Spina Ø 13

Ricambi - Spare-parts

- 215 131 01 Spina singola Ø 9
- 215 131 02 Spina singola Ø 13

Kit messa in fase motori Ford 1.4 - 2.0 - 2.4

Engine timing tool set Ford 1.4 - 2.0 - 2.4

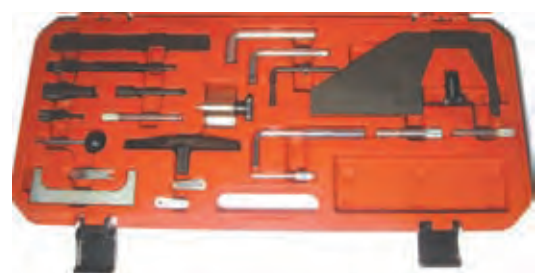

215 132 in valigetta

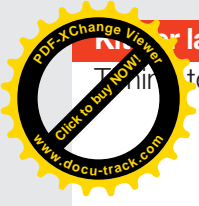

Kit messa in fase motori Ford

Timing tool set for Ford



215 133 10 Fiesta - Fusion 1.2 / 1.4 / 1.6
Focus - C Max 1.4 / 1.6

Kit fasatura distribuzione motori Ford Focus e CMax

Timing tool set for Focus e CMax



215 133 20

Dati tecnici - Informative

I cinque particolari del kit sono essenziali per la messa in fase dei motori Ford Focus / CMax
1.6 Ti-VCT con codice motore HXDA (03/07)
2.0 TDCI con codice motore G6DA-G6DB-G6DC (03/07)

Kit messa in fase motori Ford Duratorq Diesel 2.0 - 2.2 - 2.4

Tool kit Diesel 2.0 - 2.2 - 2.4 TDDI - TDCI



215 134

Confezione messa in fase motori: Fiat 4HV; Peugeot P22DTE (4HV - 4HU) 2.2 TDCi - HDi

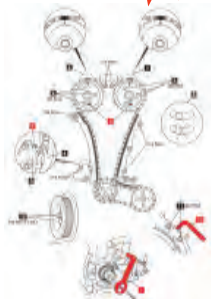

215 134 10 Kit completo in blister

Ricambi - Spare-parts

- 215 131 02 Perno blocco volano motore
- 215 139 03 Perno blocco pulegge camme (2Pz)
- 215 155 03 Perno blocco tenditore catena
- 215 134 11 Staffa blocco motore

Kit messa in fase cinghia distribuzione motore Ford 1.4 TDCi / 1.6 TDCi e Citroen / Peugeot 1.4 HDI

Timing tool for 1.4 & 1.6 TDCi & Peugeot 1.4 HDI



215 134 20 In blister

Ricambi - Spare-parts

215 134 21 Perno albero motore

215 134 22 Perni puleggia camme e pompa gasolio

215 134 23 Perno ghiera posteriore puleggia

Attrezzo mantenimento in fase pulegge distribuzione

Tool for camshaft regulation



215 135 Motor/Engine VW 1.4 16V - 1.6 16V

Attrezzo blocco albero a camme per fase motori Audi A3 e Golf IV

Wrench for block distribucion Audi A3 and Golf IV



215 136 Kit completo

Ricambi - Spare-parts

- 215 136 01 Staffa
- 215 139 03 Perno blocca puleggia

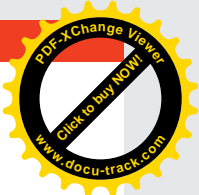
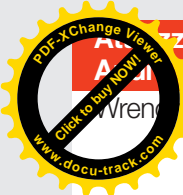

Attrezzo blocco Albero a camme motori cilindri TDI e furgoni VW LT

Wrench to block camshaft Audi 5 cylinder TDI and VW LT

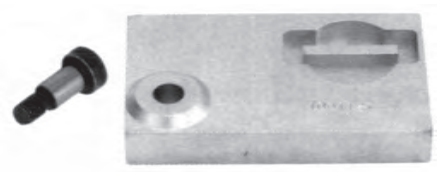

215 137

Attrezzo blocco alberi a camme motori VW-Seat-Skoda V6 TDI

Block camshaft tool for VW-Seat-Skoda V6 TDI motors



215 139 Kit Completo

Ricambi - Spare-parts

- 215 139 01 Particolare 1 - Coppia staffe
- 215 139 02 Particolare 2 - Perno blocco albero motore
- 215 139 03 Particolare 3 - Perno forato

Kit montaggio organi distribuzione composto da staffa bloccaggio doppio albero a camme e perno per rilevamento P.M.S.

Kit for camshaft regulation with tool for locking double camshaft and pin for checking T.D.C.



215 141

Perno utilizzabile anche per motori Diesel

215 142

215 140 Kit completo - Renault Mot. 1.4-1.6-1.8-2.0 16V

Ricambi - Spare-parts

- 215 141 Perno di ricambio - Renault Mot. 1.4-1.6-1.8-2.0 16V
- 215 142 Staffa di ricambio - Renault Mot. 1.4-1.6-1.8-2.0 16V

Perno per la messa in fase motori Renault DCI 1.5

Tool for deterring TDC Renault 1.5 DCI



215 141 01

Kit fasatura distribuzione motori Renault 2.0 F5R

Timing tool set for Renault 2.0 F5R Model



215 141 10

Allineamento puleggia alberi a canne

Tool for camshaft regulation



215 143 Motor/Engine Renault - 1.4 - 1.6 16 V

Attrezzo fasatura pompa iniezione motori Renault 1.9D

Kit check pumps injection motor Renault 1.9D



215 144 01

Attrezzo bloccaggio ruota dentata pompa iniezione motori Renault 1.9D

Kit block cogwheel it pumps injection motor Renault 1.9D



215 144 02

Chiave ritegno ingranaggio pompa olio motori Renault Scenic - Clio e megane 1.6 - 8 valvole



215 144 05

Attrezzo blocca pompa iniezione Renault 1.9 TDI

Tool for Renault 1.9 TDI



Clio - Megane - Laguna Kangoo

215 144 10 in blister

NOTE



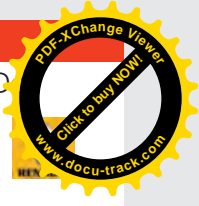

Kit messa in fase motori Renault 2.2 Dci e 2.5 Dci

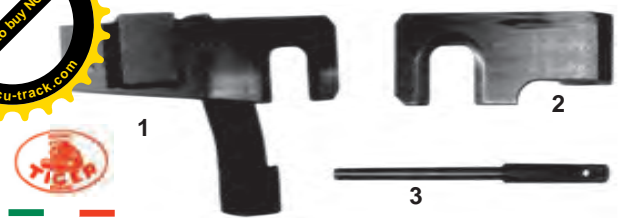

215 145 Kit Completo

Ricambi - Spare-parts

- 215 145 01 Staffa Blocco cam aspirazione 1
- 215 145 02 Staffa Blocco cam scarico 2
- 215 145 03 Perno blocco albero motore 3

Kit messa in fase motori Renault 2.2 Dci e 2.5 Dci

Kit for camshaft regulation Renault 2.2 Dci and 2.5



215 145 10

Piastra allineamento puleggia alberi a camme motori Renault DCI 1.5 - 1.9

Tool to lock driving pulley while setting



215 146

Kit messa in fase motori Renault

Timing tools Renault



215 146 10 in valigetta

Dati tecnici - Informative

- Twingo 1.2
- R19 + Express + Extra + Rapid 1.4
- Scenic 1.4/1-6/2-0 16V
- Laguna 1.6 16V - 1.8+2.0 - 1.8+2.0 16V - 2.2D/TD - 2.5D/Td
- Safrane 2.0 16V - 2.2 Td - 2.5 20V
- Clio 1.2/1.4 - Clio 1-4/1.6/1.8/ 16V - Clio sport 2-0 16V
- Master 2.5 D/Td
- Trafic 2.5D -
- Espace 2.0 - 2.0 16V - 2.2Td

Kit messa in fase alberi a camme 2.0 DCI

Tool to lock driving pulley while setting 2-0 DCI



215 147 in valigetta

Ricambi - Spare-parts

- 215 147 01 Perno blocco albero motore
- 215 147 02 Perno blocco ingranaggio in 2 pezzi albero a camme aspirazione
- 215 147 03 Piastra blocco puleggie distribuzione

Attrezzo estrazione pompa iniezione e mantenimento ingranaggio distribuzione motori Renault 2.2 e 2.5

Set for extraction and maintenance of distribution gear on engine Renault 2.2 & 2.5



215 148

Kit messa in fase motori GM ecotech 2.0

Engine timing tools Seat - VGA



215 149

Kit montaggio distribuzione OPEL 2.0 TD 16V

Assembling tool for crankshaft OPEL 2.0 TD 16V



215 150 Kit completo in valigetta

Ricambi - Spare-parts

- 215 151 Piastra bloccaggio camme
- 215 152 Perno bloccaggio albero motore
- 215 153 Perno bloccaggio pompa iniezione

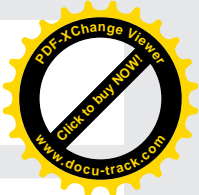
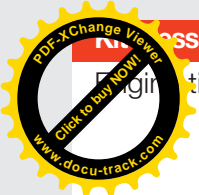

Stessa in fase motori Diesel 1.7 Opel & Isuzu

Engine timing tools set Diesel 1.7 Opel & Isuzu



215 154 in valigetta

Kit messa in fase motori Opel 1.0 - 1.2 16V - 1.4 16V

Kit test distribucion opel 1.0 - 1.2 16V - 1.4 16V motors



215 155 Kit Completo in valigetta

Ricambi - Spare-parts

- 215 155 01 Particolare 1 - staffa ruota fonica
- 215 155 02 Particolare 2 - perno blocco albero motore
- 215 155 03 Particolare 3 - Ø 2 mm - perno blocco tenditore
- 215 133 Particolare 4 - staffa blocco alberi a canne

Kit messa in fase motori 2.2 16V

Petrol 2.2 16V (chain) Timing + Water pump tool set



215 156 Opel Astra - Vectra - Zafira - VX 220 - Signum

Kit messa in fase albero motore FIAT EVO 2 - 8V

Engine timing tool set Fiat EVO 2 - 8V



215 158 00

motori
1.2 8V
1.4 8V
in valigetta

Ricambi - Spare-parts



215 158 01 Staffa blocco albero motore



215 158 02 Staffa messa in fase albero a camme



215 158 03 Piastra posizionamento coperchio testa cilindri



215 158 04 Staffa reazione puleggia distribuzione 1.4 8V



215 610 Attrezzo per rotazione tenditore cinghia distribuzione

Piastra bloccaggio albero distribuzione



215 161 Opel 1.6 Diesel - Corsa - Kadett - Vectra

Piastra messa in fase albero distribuzione



215 163 Opel astra 1.7 D - Da utilizzare con 214 226

Kit fase motori AUDI AJM 115-130-150 CV

Tool for setting crunkshaft AUDI AJM 115-130-150 CV



215 139 03



215 580



215 497



215 632 01

215 165 in valigetta

NOTE



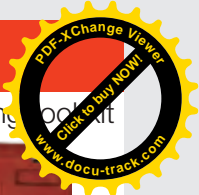
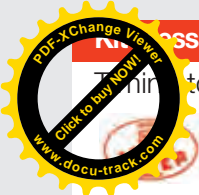

Kit messa in fase motori Audi / Skoda / Vw

Timing tool set for engine Audi / Skoda / Vw



215 166

Ricambi - Spare-parts



215 497 Staffa blocco albero motore 1.4 - 1.9 TDI



215 498 Staffa bolocco albero motore 2.0 TDI

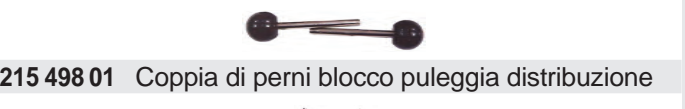

215 498 01 Coppia di perni blocco puleggia distribuzione

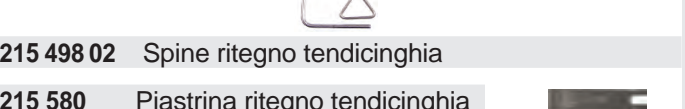

215 498 02 Spine ritegno tendicinghia

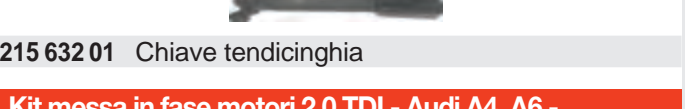

215 580 Piastrina ritegno tendicinghia



215 632 01 Chiave tendicinghia

Kit messa in fase motori 2.0 TDI - Audi A4, A6 - Skoda Octavia - Vw Golf, Golf Plus, Jetta e Touran

Timing tool set for VAG 2.0 TDI



215 167
Kit 6 Pz

Ricambi - Spare-parts



215 497 Staffa blocco albero motore Vw 1.4 - 3 Cil 1.9 D - AJM



215 498 Staffa bolocco albero motore 2.0 TDI

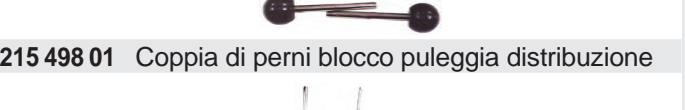

215 498 01 Coppia di perni blocco puleggia distribuzione

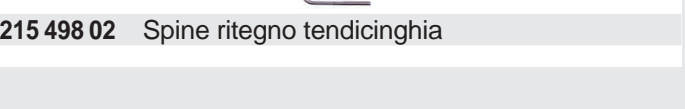

215 498 02 Spine ritegno tendicinghia

Kit messa in fase motori Audi - Volkswagen - Skoda - 1.4 - 1.6 FSI - TSI

Petrol engine twin camshaft setting / locking tool kit



215 168

Kit messa in fase catena nella testata, Audi e Vw 2.0 FSI / TFSI

Petrol engine twin camshaft setting tool kit



215 169
in valigetta

Audi: A3 2.0 FSI (03)
Audi: A4 2.0 TFSI (04)
Audi: A6 2.0 TFSI (06)
Vw: Golf, Touran 2.0 FSI (03), Passat 2.0 TFSI (05)

Kit fase VW VGA - 2.4D

Engine timing tools for Vw VGA - 2.4D



215 170

Dati tecnici - Informative

- Anno 02 / 1995 - 2003 Motori AAB - AJA

Kit messa in fase Land Rover - Jaguar

Land Rover / Jaguar engine timing tools kit



215 175
in valigetta - Pz 5

Dati tecnici - Informative

Rover discovery 2.7TD V6 - Range Rover Sport 2.7TD V6
Jaguar TD V6

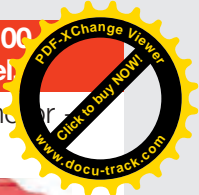
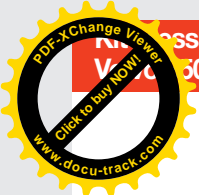

Messa in fase alberi a camme su motori VW 960-960-S40-S70-S90



215 180
In valigetta

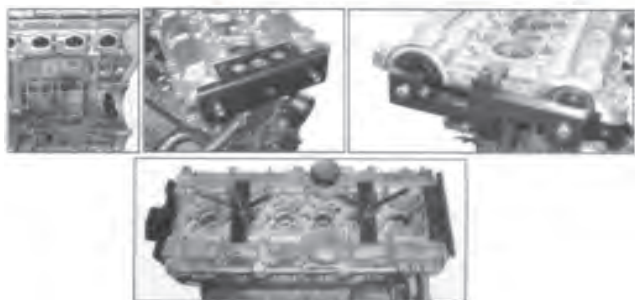

Kit messa in fase Vw - Audi - Seat 1.8

Volkswagen timing tool



215 200
in blister5

Dati tecnici - Informative

- Audi: A3 - S3 - A4 - A6 - TT
- Seat: Ibiza - Cordoba . Leon - Toledo - Alhambra
- Skoda: Octavia
- Vw: Golf - Bora - Bettle - Passat

Kit in valigetta fasatura distribuzione per una larga gamma di motori Mercedes sia diesel che benzina e motori Chrysler 2.2 CRD e 2.7 CRD

Timing tool set for Mercedes and Chrysler 2.2 / 2.7



215 470

Kit fasatura distribuzione per motori Audi 100 e A6 con motore Z15L TDI e VW Polo Diesel

Timing tool set for Audi 100 and A6 Z15L motor and VW Polo Diesel



215 474

Kit fasatura motori Bmw-Mini / Citroen / Peugeot

Petrol engine twin camshaft setting/locking tool



215 477
in valigetta

- BMW MINI - CITROEN - PEUGEOT (1.4 / 1.6 16V valvetronic)
- Bmw mini: R55 - R56 COOPER S
- Bmw mini: R55 - R56 COOPER
- Bmw mini: R56 MINI ONE
- Citroen: C4 - C4 Picasso
- Peugeot: 207 - 308
- Bmw: N12 (1.4 - 1.6)
- Bmw: N14 (1.6)
- PSA: EP3 - EP6 - EP6DT - DTS

Kit fasatura distribuzione per BMW Mini

EngineTiming Tool Kit for BMW Mini



Per motori:
8 Valvole

215 478 In valigetta

Dati tecnici - Informative

- Anno 2001-06 Mini cooper W10B16AA
- Anno 2001-06 Mini cooper S W10B16BA
- Anno 2002-06 W11B16AA

Kit fasatura distribuzione per BMW Mini One

EngineTiming Tool Kit for BMW Mini One



Per motori:
8 / 16 Valvole

215 479
in valigetta

Dati tecnici - Informative

- Anno 2001-06 Mini One W10B16AA
- Anno 2001-06 Mini cooper W10B16BA
- Anno 2002-06 Mini Cooper W11B16AA
- Motore N 14



Universale estrazione pulegge - Poly V

Universal pulley puller set



215 480

Blocca puleggia universal

2 Way universal timing belt locking tool

215 484 in valigetta



Attrezzo universale bloccaggio pulegge distribuzione con 4 settori dentati orientabili.

Universal tool for block camshaft wheel.

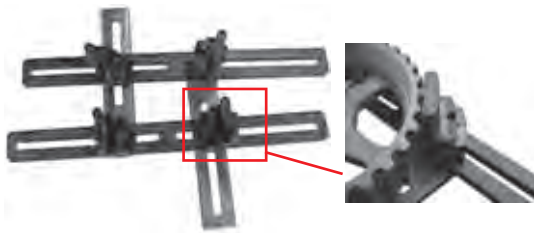

215 485 Kit composto da 4 staffe corte e 2 lunghe

Kit estrazione pulegge VW Audi

EngineTiming Tool Kit for BMW Mini



215 486 Per motori Audi - Vw - 4 e 6 cilindri

Estrattore pulegge con 8 fori a losanga per viti M8 & M10

Extractor pulleys with 8 holes for M8 & M10 screw



215 487 Ø100 - utilizzabile con 3, 4 o 6 viti Ford Fiesta

Estrattore puleggia albero motore Ford Focus

Extractor for Ford Focus camshaft pulley



215 488

Ø 80 - 4 piedini

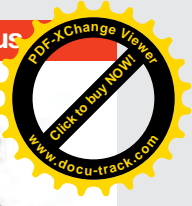

Attrezzo bloccaggio volano motore Ford

Block wheel for Ford



215 489

Kit attrezzi bloccaggio pulegge distribuzione motori

Driving pulley retainer tool kit

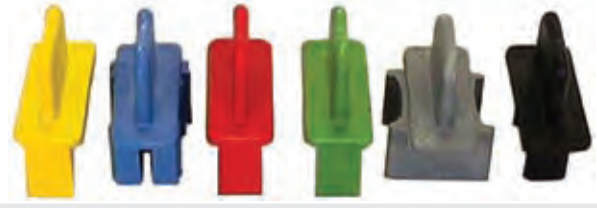

215 490 Kit completo

215 490 01 Giallo/Yellow/Amarillio - OPEL 16V 1800/2000

215 490 02 Blu - OPEL 16V 1400/1600

215 490 03 Verde/Green/Vierde - OPEL V6 2500/3000

215 490 04 Rosso/Red/Roco - OPEL V6 2500/3000

215 490 05 Grigio/Gray/Gris - SAAB - 900/900 0

215 490 06 Nero/Black/Negro - ROVER - Tipo K16

Attrezzo blocco pulegge alberi a camme - 1.8 - 16V



215 491

Con riferimento marcato al laser per facilitarne l'utilizzo

Kit attrezzi bloccaggio pulegge e volano su motori Opel - Saab - Rover - Isuzu - VW



215 492

in metallo

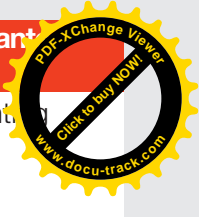

blocco albero motore VW 1.4 TDI - 1.9 TDI

block camshaft VW 1.4 TDI - 1.9 TDI



215 497

Vedi Kit 215 165 / 215 166 / 215 167

Staffa blocco albero motore 2.0 TDI



215 498

Coppia perni blocco tenditori cinghia distribuzione



215 498 02

Attrezzo per fermo puleggia albero motore

Tool for retaining crankshaft pulley



215 501 Alfa 164 2,5 TD

Attrezzo per fermo albero distribuzione durante smontaggio albero motore

Tool for retaining crankshaft during dismounting



215 502 Audi 5 cil. da usare/use with/con 215 520

Attrezzo per fermo albero distribuzione durante smontaggio albero motore

Tool for retaining crankshaft during dismounting



215 503 Audi 6 cil. da usare/use with/con 215 520

Attrezzo per fermo albero distribuzione durante smontaggio albero motore

Tool for retaining crankshaft during dismounting



215 504 Audi 6 cil.mot. WOS da usare conr/use with/ con 215 524

Chiave tensionamento puleggia organi ausiliari

Wrench for tensioning auxiliary



215 510 Marea-Marea week end 2400 D - 32 mm

Chiave smontaggio puleggia albero motore BMW con dump (antivibrazione)

BMW key crankshaft pulley removal with dump



215 515

mm 350



215 516

mm 345



| | A | B | C |
|---------|--------|--------|-------|
| | Ø est. | Ø int. | Dente |
| 215 515 | 63,5 | 57,3 | 15 |
| 215 516 | 68,5 | 57,5 | 15 |

Chiave dado fissaggio puleggia albero motore

Wrench for nut fixing pulley on crankshaft



- 215 520 Audi - 27 mm
- 215 521 Uno 60/70/turbo ie-Ritmo 60/ES/70/85-Regara 70/ES/-75/85 - 30 mm
- 215 522 Fiat 126-900T-Panda 30-Punto 1108/1242 SPI/ MPI - 32 mm
- 215 523 Fiat 124 Spider-125 - 34 mm
- 215 524 Audi mot. 6cil-127-Panda 45-131 D- Punto 1372 Turbo - 36 mm
- 215 525 127 - 1050 - 128 - Ritmo - 131B - 132B - Campagnola - Ritmo - D-Uno 60/70 Turbo ie Regata 70ES/75/85 - 38 mm

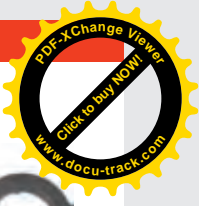

Chiave dado fissaggio puleggia albero motore

Wrench for nut fixing pulley on crankshaft



215 530 Alfa sud-Arna-33 - 27 mm

Chiave dado fissaggio puleggia albero motore

Wrench for nut fixing pulley on crankshaft



215 540 Kappa - 19 mm

Attrezzo per smontaggio pulegge multigola poliv

Pulley removing wrench



215 543 Zeca 719

Attrezzo bloccaggio puleggia trapezoidali

Tool locking pulley



215 544 Universale

Attrezzo bloccaggio puleggia distribuzione

Tool locking camshaft pulley



215 545 Alfa Sud-33

Attrezzo rotazione organi distribuzione motori con 4 perni riposizionabili



215 548

Kit completo per flange rotazione motori Fiat

Universal tool locking camshaft pulley



Supporto 215 549

mm 350

Flangia 215 550

Flangia 215 551

Flangia 215 552



Flangia 215 553

Flangia 215 554



215 555 Kit completo in valigetta

Ricambi - Spare-parts

215 549 Supporto

215 550 Flangia Lancia Kappa- 164 24 V - Multipla Bipower

215 551 Flangia Bravo - Brava - 145 - 146

215 552 Flangia Coupè - Barchetta - 146 2000 cc

215 553 Flangia Marea Week-end 1910-2400cc

215 554 Flangia rotazione puleggia distribuzione motori Multijet

Attrezzo rotazione organi distribuzione motori Ford

Key rotation distribution Ford Motor



215 558 con perni Ø 17 mm

Attrezzo rotazione organi distribuzione motori NISSAN - TOYOTA

Key rotation distribution NISSAN - TOYOTA Motor



215 560

Attrezzo rotazione organi distribuzione motori TOYOTA e LEXUS

Key rotation distribution LEXUS - TOYOTA Motor



215 562

Attrezzo per tensionamento cinghia dentata comando distribuzione

Devices for tension of toothed timing belt

perno filettato m 8x1,25



215 570 Bravo-Brava 1581 16v

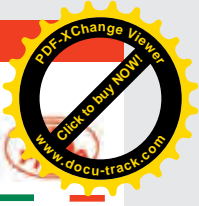
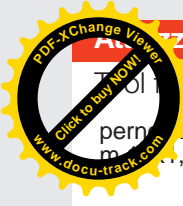

Attrezzo tendicinghia motori Fiat 1.6 16V



215 571 Fiat Multipla Bipower - Fiat Stilo

Perno filettato M10x1.25 per Multipla Bipower e Stilo



215 571 01 intercambiabile all'attrezzo art.215 570

Attrezzo tendicinghia femmina per motori Alfa Romeo

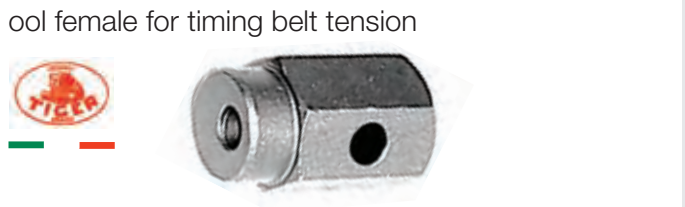

215 572 Alfa Romeo

Attrezzo tendicinghia maschio per motori Alfa Romeo



215 573 Alfa Romeo

Attrezzo tendicinghia motori Renault Megane



215 574 Renault Megane

Chiave tensionamento cinghia Renault



215 575 Benzina - quadro mm 8x180
215 576 Diesel - quadro mm 9x200

Piastrina ritegno tendicinghia motori VW AJM



215 580

Set chiavi smontaggio ventilatori VISCO



215 590 BMW - FORD - MERCEDES - OPEL

Chiavi smontaggio elettroventole BMW e AUDI

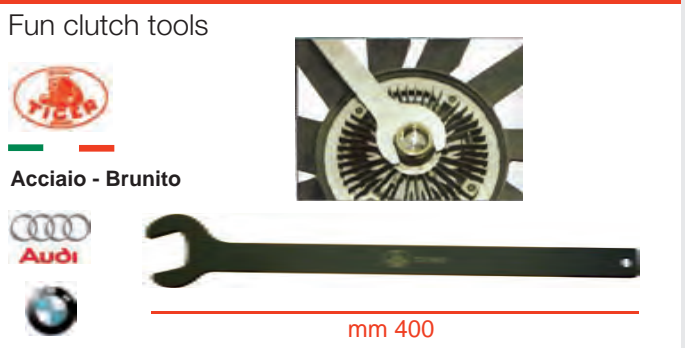

215 590 32 mm 32
215 590 36 mm 36

Attrezzo inserimento / rimozione cinghie elastiche



215 605 in valigetta
Dati tecnici - Informative
- Motori con pulegge elastiche: Alfa Romeo - Bmw - Chrysler - Volvo - Fiat - Ford - Mercedes - PSA - Seat - Skoda - Smart - Vw-Audi - etc

Chiave tendicinghia



215 609
Lunghezza mm 47 - Profondità mm 32,5
Dati tecnici - Informative

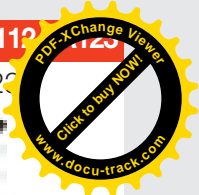
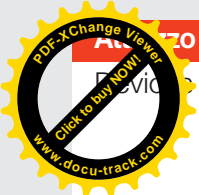

Attrezzo per rotazione tenditore cinghia distribuzione

Devices for tension of timing belt



215 610 Nuova Punto Lancia Y - Mot.Eng.1200 cc 16v

Attrezzo per tensionamento cinghia dentata comando distribuzione

Devices for tension of toothed timing belt



215 612
215 613
215 614

215 611 Uno 45-Fire-Tipo-Ritmo-Tempra-Regata-Croma - Thema ie/16 v Turbo-Punto -Alfa-155-164 Kit completo

Ricambi - Spare parts

215 611 Uno 45-Fire-Tipo-Ritmo-Tempra-Regata-Croma - Thema ie/16 v Turbo-Punto -Alfa-155-164

215 612 Staffa tonda / Round staff / Recambio redondo

215 613 Perno / Pin / Recambio - 6-6 mm

215 614 Perno / Pin / Recambio - 6-8 mm

Attrezzo per tensionamento cinghia dentata comando distribuzione

Devices for tension of toothed timing belt



215 616 Ritmo Diesel

Attrezzo per tensionamento cinghia

Devices for tension of toothed timing belt



215 617

Perno per tensionamento cinghia dentata comando distribuzione

Devices for tension of toothed timing belt



215 618 Fiat Ulisse

Attrezzo rotazione albero motore Mercedes A112

Flywheel rotation tool Mercedes A112 - A120



215 619 L= mm 700

Attrezzo fermo puleggia dentata organi ausiliari

Devices for locking service belt



215 621 127-Uno 60/70/Turbo-Ritmo 60/es/70/85-Regata 60/ - S/70/85

Attrezzo fermo puleggia dentata organi ausiliari

Devices for locking service belt



215 622 127 1050-Rustica-Ritmo 60

Attrezzo montaggio smontaggio tendicinghia

Devices for dismounting timing belt turnbuckle



215 624 Bravo 1998 20v-Kappa Motor Vis

Bussola femmina per vite puleggia albero motore Toyota 1ZZ-FE

1/2" 10S size: 1/2"DR X 10S, HEX21mm

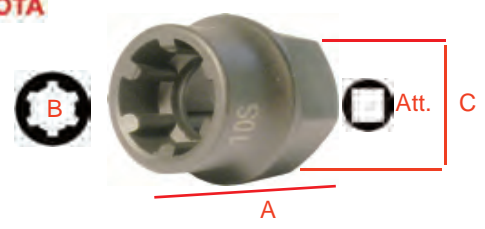

| | A | B | C | Att. |
|---------|----|-----|---------------|------|
| 215 625 | 32 | 10S | Esagono mm 21 | 1/2" |

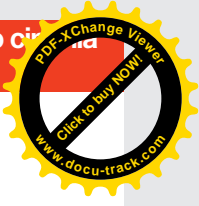

Chiave tendicinghia Motori Audi

Wrench for tension toothed belt



Acciaio - Brunito



mm 600

215 626 mm 46

Bussola femmina per viti testate e vite centrale puleggia albero motore Nissan

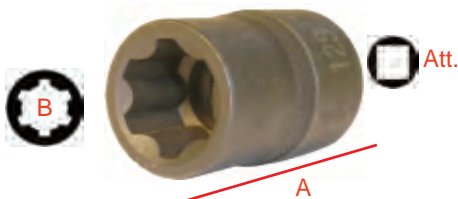

| | A | B | Att. |
|---------|----|-----|------|
| 215 627 | 38 | 12S | 1/2" |

Chiave tendicinghia Motori Ford

Wrench for tension toothed belt



Acciaio - Brunito

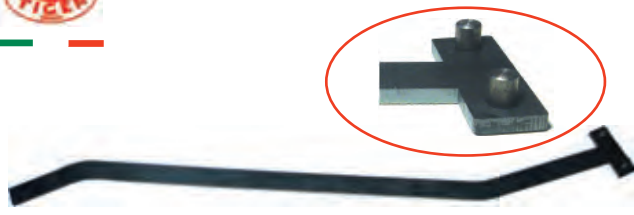

215 628

mm 840

Chiave per pulegge e organi ausiliari

Benz fan belt service wrench

215 629



Att. mm8 (5/16")



Att. 1/2"



mm 500

Dati tecnici - Informativi

Strumento universale ideato per Mercedes e Nissan. L'attacco maschio quadro 1/2" da un lato, l'esagono porta inserti da 8mm (5/16") dall'altro, disegnati su di una barra stretta, lunga, piatta e molto resistente permette di lavorare in più zone con accesso confinato

Chiave manovra semipuleggia tensionamento comando pompa acqua

Wrench for water pump belt



215 630 Cromo D/TD

Chiave manovra semipuleggia tensionamento cinghia comando compressore condizionamento

Wrench for air conditioned compressor belt



215 631 Cromo D/TD

Chiave tendicinghia

Wrench for tension toothed belt



215 632 Golf 1600- Golf TD

215 632 01 Lunga per motori AJM-115-130-150 CV

Set 5 Pz chiavi poligonali piatte, sottili, lunghe, per rotazione pulegge distribuzione, organi ausiliari e tendicinghia

5 Pcs polygonal wrench set, long and flat, for pulley and tension toothed



mm 560

215 634 mm 13 - 15 - 16 - 17 - 19

215 634 12 Non inclusa nel set - mm 12

215 634 13 mm 13

215 634 14 Non inclusa nel set - mm 14

215 634 15 mm 15

215 634 16 mm 16

215 634 17 mm 17

215 634 18 Non inclusa nel set - mm 18

215 634 19 mm 19

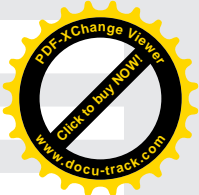
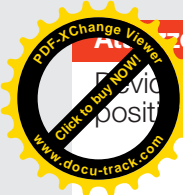

Attrezzo per posizionamento piastrina porta sensore

Device for little plate positioning side camshaft



215 635 Ritmo ES

Calibro controllo posizionamento tendicinghia distribuzione

Gauge control positioning of toothed timing belt turnbuckle



215 636 127 D

Attrezzo ritegno supporto centrale per smontaggio albero distribuzione

Tool retainment central engine support during replacement and installation of camshaft



215 637 127 D

Chiave serraggio tendicinghia Motori Renault Benzina

Wrench for tension toothed belt Renault engine gasoline



215 638

Set chiavi poligonali piatte - sottili - con occhiello rinforzato, per pulegge distribuzione, organi ausiliari e tendicinghia

5 pcs damper pulley puller set



215 639 mm 13 - 15 - 16 - 17 - 19 - Valigetta Pz 5

mm 470

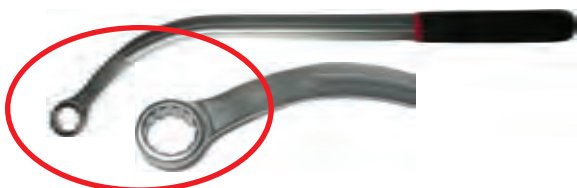

Ricambi - Spare-parts

- 215 639 13 Chiave singola mm13
- 215 639 15 Chiave singola mm15
- 215 639 16 Chiave singola mm16
- 215 639 17 Chiave singola mm17
- 215 639 19 Chiave singola mm19

Set chiavi poligonali lunghe piatte con anello alto e sottile, ideale in officina per pulegge ed organi di servizio

Extra long off set box poligonal wrench set

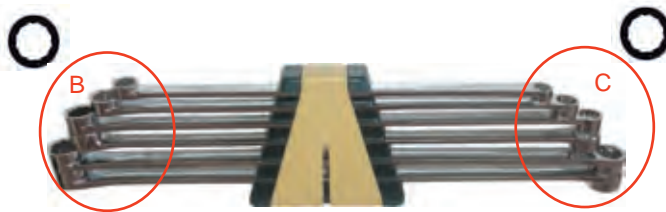

A

215 640 Kit 6 Pz

Ricambi - Spare-parts

| | A | B | C |
|------------|--------|-------|-------|
| 215 640 10 | mm 290 | mm 10 | mm 12 |
| 215 640 12 | mm 360 | mm 12 | mm 14 |
| 215 640 13 | mm 360 | mm 13 | mm 15 |
| 215 640 14 | mm 400 | mm 14 | mm 17 |
| 215 640 16 | mm 400 | mm 16 | mm 18 |
| 215 640 17 | mm 400 | mm 17 | mm 19 |

Adattatori opzionali - Optional adaptor

215 640 22 Non inclusa nel set mm 450 mm 22 mm 24

Set chiavi Torx piatte, sottili, con occhiello rinforzato, per tendicinghia e organi ausiliari

5 pcs damper pulley puller holder wrench set



215 641 E10 - E12 - E14 - E16 - E18

Attrezzo universale per il montaggio e lo smontaggio delle cinghie elastiche

Tacca sulla parte superiore per lo slittamento della cinghia



Guida per la puleggia sulla parte posteriore

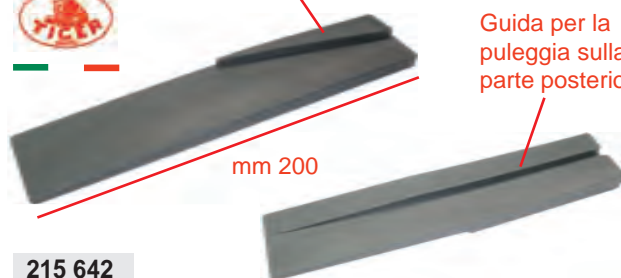

215 642

Vedi anche 215 605.

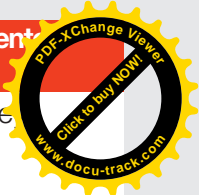

Chiave di smontaggio per pulegge albero motore

Hand wrench for crankshaft pulley



215 643 In valigetta

Dati tecnici - Informative

- Per Vw Audi 4 & 5 cilindri con e senza l'ammortizzatore armonico
- Ideale per la sostituzione cinghia di distribuzione
- Utilizzabile anche da un singolo meccanico

Chiave a battere da 1/2" per viti pulegge

Hand impact wrench for pulley 1/2"

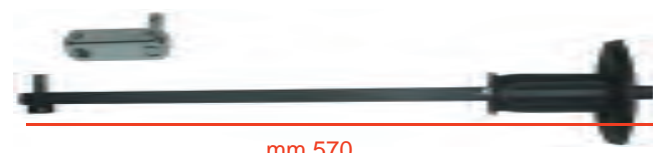

215 645 mm 570

Estrattore puleggia trascinamento albero distribuzione

Extractor for delivery driving pulley



215 650 Bravo-Brava-Punto-Tempra-145-146-Barchetta - Coupè-Lancia-Kappa-Ulisse

Estrattore registrabile per puleggia trascinamento pompa iniezione

Adjustable extractor for delivery driving pulley



215 651 2 zampe / 2 Legs / 2 patas - Ø 46-86 mm

Ricambi - Spare parts

215 653 zampa / Leg / pata

215 654 zampa / Leg / pata

Estrattore registrabile per pulegge trascinamento pompa iniezione

Adjustable extractor for delivery driving pulley



215 652 3 zampe / 3 Legs / 3 patas - Ø 46-86 mm

Ricambi - Spare parts

215 653 zampa / Leg / pata

215 654 zampa / Leg / pata

Estrattore puleggia trascinamento albero distribuzione

Extractor for delivery driving pulley



215 656 Peugeot-Passat

Estrattore estensibile per pulegge Poly V

Puller for ribbed pulleys

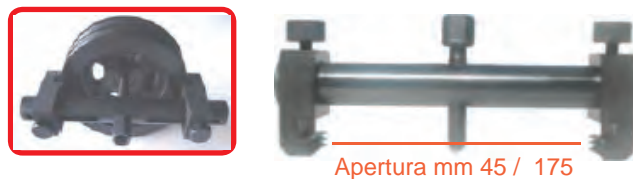

215 658

Apertura mm 45 / 175

Estrattore puleggia trascinamento albero distribuzione

Extractor for delivery driving pulley



215 660 Uno turbo D

Estrattore pulegge con zampe orientabili

Extractor pulleys with adjustable legs



215 664 FIAT - ALFA ROMEO - LANCIA





Chiave per puleggia trascinamento albero distribuzione

Wrench for delivery driving pulley



215 665 127 D

Estrattore pompa iniezione per posizionamento ingranaggio

Extractor for injection pump



215 671 Alfa 90 Bosch

Estrattore girante pompa iniezione

Extractor for turbine injection pump



215 673 Alfa 75-33 Bosch

Estrattore puleggia trascinamento elettro ventilatore

Extractor for fan coil driving pulley



215 675 Alfa 164 TD

Attrezzo per posizionamento girante pompa acqua

Devices for positioning water pump impel



215 677 Ritmo D

Introduttore corteco albero distribuzione lato aspirazione

Oli seal camshaft introducer



215 678 145-146-Spider Alfa-Bravo-Brava-Coupè

Chiave per smontaggio alternatori

Wrench for alternator disassembly

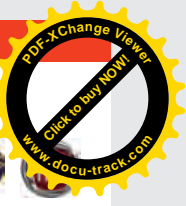

215 679 Alfa 159 - Fiat Nuova Croma

Attrezzo per sostituziune cinghie alternatore

Devicev for alternator pulley dismounting



215 680 Golf / Passat G 60

Chiave per lo smontaggio e montaggio alternatori

Alternator wrench



mm 90

215 681 Fiat Bravo. Grande Punto

Kit inserti per alternatore

Alternator bits



mm 120

215 682 Pz 5

Ricambi - Spare parts

| | | |
|------------|-----------------------------------|------------|
| 215 682 01 | Inserto esagonale per alternatore | 8 x 120 |
| 215 682 02 | Inserto esagonale per alternatore | 10 x 120 |
| 215 682 03 | Inserto XZN per alternatore | M 8 x 120 |
| 215 682 04 | Inserto XZN per alternatore | M 10 x 120 |
| 215 682 05 | Inserto Torx per alternatore | T50 x 120 |
| 415 661 41 | Innesto 14x18 | mm 41 |

Chiave per lo smontaggio puleggia alternatori

Alternator wrench



mm 110

215 683 Tx 50 Classe - A

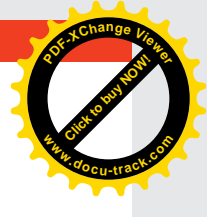
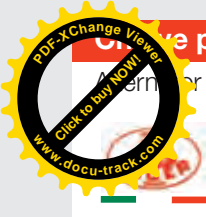

Chiave per lo smontaggio alternatori Valeo

Alternator wrench



mm 110

215 684 Chiave XZN M10 con esagono

Ricambi - Spare parts

215 6840 1 Solo esagono mm 28

Chiave per lo smontaggio alternatori Valeo

Alternator wrench - Valeo



mm 110

215 684 02 Renault

Chiave smonta alternatori VAG - MB - Bmw

Alternator wrench



215 684 03 XZN M10

Chiave multi denti per puleggia alternatore bosch

Tool for alternator pulley dismounting



215 685

215 686



mm 50

mm 30

215 685 Audi - Volkswagen

215 686 Fiat

Chiave per lo smontaggio alternatori

Alternator wrench



mm 100

215 686 01

Dati tecnici - Informative

*Nata per la Nuova Alfa Mito è indicata per tutti i motori Fiat - Alfa - Lancia, dal 2007 in poi.

Ricambi - Spare parts



215 686 11 Chiave alternatori Fiat - Alfa - Lancia dal 2007 in poi

Chiave multidententi per puleggia Mito

Alternator wrench for Mito



215 686 12

Kit per lo smontaggio della puleggia alternatori Bosch - Marelli



215 687 Pz 7

Ricambi - Spare parts

215 686 Chiave multidentata corta

215 689 Chiave a 4 denti per dado puleggia

411 756 Bussola porta inserti

215 682 01 Inserto esagonale per alternatore - 8 x 120

215 682 02 Inserto esagonale per alternatore - 10 x 120

215 682 03 Inserto XZN per alternatore - M 8 x 120

215 682 04 Inserto XZN per alternatore - M 10 x 120

Kit per lo smontaggio della puleggia alternatori Bosch - Marelli



215 688 Pz 8

Ricambi - Spare parts

215 686 Chiave multidentata corta

215 689 Chiave a 4 denti per dado puleggia

234 134 Chiave a bussola foro passante mm 22

411 756 Bussola porta inserti

215 682 01 Inserto esagonale per alternatore - 8 x 120

215 682 02 Inserto esagonale per alternatore - 10 x 120

215 682 03 Inserto XZN per alternatore - M 8 x 120

215 682 04 Inserto XZN per alternatore - M 10 x 120

NOTE



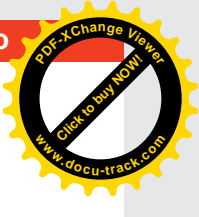
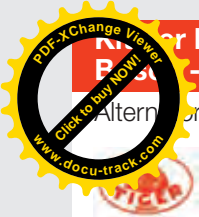

Kit per lo smontaggio della puleggia alternatori Bosch - Marelli



215 688 01 Pz 9

Ricambi - Spare parts

- 215 686 Chiave multidentata corta
- 215 689 Chiave a 4 denti per dado puleggia
- 234 134 Chiave a bussola foro passante mm 22
- 234 135 Chiave a bussola foro passante mm 24
- 411 756 Bussola porta inserti
- 215 682 01 Inserto esagonale per alternatore - 8 x 120
- 215 682 02 Inserto esagonale per alternatore - 10 x 120
- 215 682 03 Inserto XZN per alternatore - M 8 x 120
- 215 682 04 Inserto XZN per alternatore - M 10 x 120

Kit per lo smontaggio della puleggia alternatori Bosch - Marelli - Valeo



215 688 02 Pz 11

Ricambi - Spare parts

- 215 682 Kit 5 inserti
- 215 684 01 Solo esagono da mm 28 per puleggia
- 215 686 Chiave multidentata corta
- 215 689 Chiave a 4 denti per dado puleggia
- 234 134 Chiave a bussola foro passante mm 22
- 234 135 Chiave a bussola foro passante mm 24
- 411 756 Bussola porta inserti

Kit per alternatori Bosch, Marelli e Valeo



215 688 10 Kit in valigetta - 11 Pz

Ricambi - Spare parts

- 215 682 01 Inserto esagonale per alternatore 8 x 120
- 215 682 02 Inserto esagonale per alternatore 10 x 120
- 215 682 03 Inserto XZN per alternatore M 8 x 120
- 215 682 04 Inserto XZN per alternatore M 10 x 120
- 215 682 05 Inserto Torx per alternatore T50 x 120
- 215 684 01 Esagono mm 28 Valeo
- 215 686 Chiave multi denti Bosch
- 215 689 Chiave a 4 denti Marelli
- 234 134 Chiave a bussola con foro passante 22
- 234 135 Chiave a bussola con foro passante 24
- 411 756 Bussola porta inserti esagonale 10x1/2"

Kit per alternatori Bosch - Marelli - Valeo

16 Pcs V-belt pulley remover bit socket set



215 688 16 16Pz

Kit per alternatori Bosch - Marelli - Valeo

18 Pcs V-belt pulley remover bit socket set



215 688 18 18Pz

Kit per alternatori Bosch - Marelli - Valeo

22 Pcs V-belt pulley remover bit socket set



215 688 22 22Pz

Novità: Nel set è inclusa la nuova chiave a 3 denti per alternatori Toyota - Mini + la nuova chiave a 33 denti per Citroen - Peugeot

Kit smontaggio puleggia alternatori Bosch - Marelli - Valeo

23 pcs V-belt pulley remover bit socket set



215 688 23 Pz 23

- Nel set sono incluse le nuove chiavi per:
- Chiave per Opel Denso
 - Chiave a 3 denti per Toyota e Mini
 - Chiave a 33 denti per Citroen e Peugeot

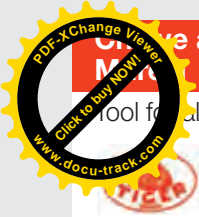

Chiave a 4 denti per dado puleggia alternatori

Tool for alternator pulley dismounting - Marelli



215 689

Leva tensionamento cinghia servizi quadro mm 7- 8

Tool for service belt



215 690 Lancia Z Td - Ulisse TD-peugeot 806 Citroen Evasion -160 mm

Adattatore per alternatori Opel / Denso

Alternator wrench Opel / Denso

Esagono femmina mm 10



Esagono maschio mm 10

mm 71

215 691

Chiave a 3 denti con esagono di manovra per lo smontaggio alternatori Nippodenso Toyota - Mini

Alternator wrench Nippodenso - Toyota - Rover



215 692

Chiave a 3 denti con manico di manovra per lo smontaggio alternatori Nippodenso Toyota - Mini

Alternator wrench Nippodenso - Toyota - Rover



Utilizzabile con bussola esagonale mm 10 - art.414 131 (non inclusa)

mm 190

215 692 01 Chiave singola

Chiave per lo smontaggio alternatori Opel - Denso

Alternator wrench -



215 693

Att. 1/2"

Pinza per acciaccatura cavi acceleratore

Wire crimping plier



215 800

Pinza fascette albero flessibile pieghevole con guaina



215 808 In blister

Pinza per fascette manicotti

Plier for manifold band



215 810

Ricambi - Spare parts

215 810 01



215 810 02



Pinza fascette manicotti bifilari piatte

Spring clip pliers



Cromate - Isolate

mm 215



mm 280

215 810 10 mm 215

215 810 11 mm 280

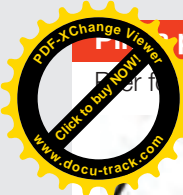

Pinza per fascette manicotti con albero flessibile

Plier for manifold band with articulation cable

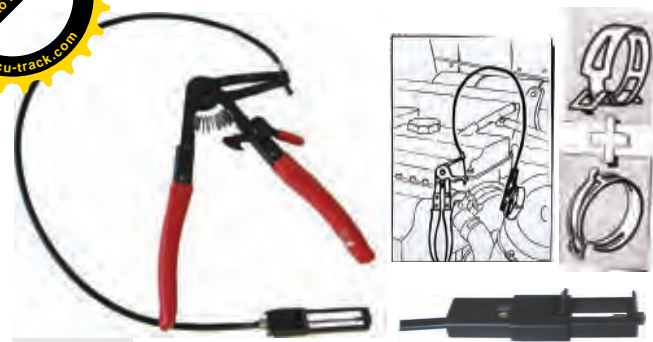

215 812

Pinza per fascette manicotti con albero flessibile

Plier for manifold band with articulation

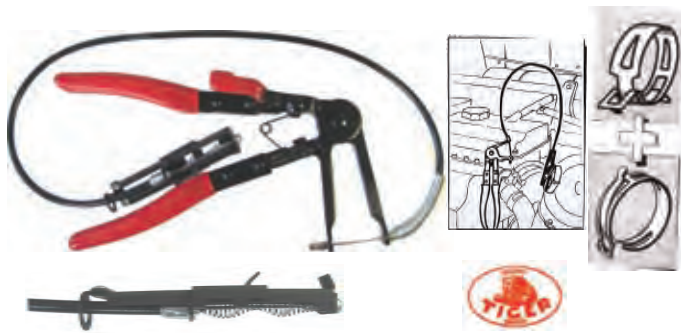

215 812 01

Filo di ricambio per 215 812 e 215 812 01

Spare steel cable for 215 812 & 215 812 01



215 812 02

Pinza per fascette EGR con albero flessibile

Plier for EGR band with articulation cable

Braccia corte per maggiore forza



215 812 03 In blister



Made in Italy

Cavo completo di pinza per ricambio

Complete spare steel cable

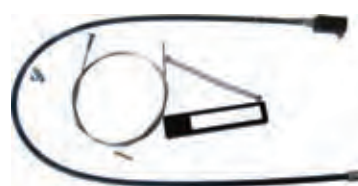

215 812 04 Ricambi per 215 812

215 812 05 Ricambi per 215 812 01

215 812 06 Ricambi per 215 812 03

Pinza per fascette manicotti a filo tondo

Plier for manifold band



215 813 mm 200

Pinza per fascette manicotti con banda piatta larga

Plier for manifold band



215 814 mm 200

Pinza per fascette manicotti con banda piatta

Plier for manifold band



215 815 mm 200

Pinza per fascette manicotto a banda larga

Plier for manifold band



215 816 Piegata 30°

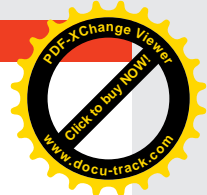

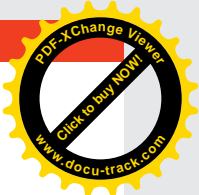

Pinza per lo smontaggio fascette manicotti dei 2.0 TDi VW - Audi

Plier for manifold band

Placca mm 16 con tacche di appoggio della fascetta mm 5



mm 235

Placca mm 20 con tacche di appoggio della fascetta mm 7



mm 300



Albero flessibile mm 700

mm 250

Placca mm 20 con tacche di appoggio della fascetta mm 7

- 215 817 Pinza mm 235
- 215 818 Pinza mm 300
- 215 819 Con albero flessibile - Pinza mm 250
- 215 819 01 Filo di ricambio

Pinza per fascette manicotti "Oeticher"

Plier for oeticher band



215 820

Pinza per fascette ad orecchio frontale

Plier for front band



215 822

Pinza per fascette manicotti extralunga

Plier extralong for manifold band



mm 356

215 823

Pinza per fascette ad orecchio laterale



215 823

Pinza per fascette tubi carburante VAG



215 830

Vw - Audi

195 mm

NOTE





www.afasupport.it

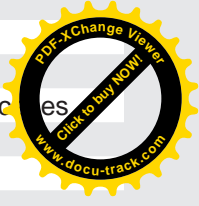
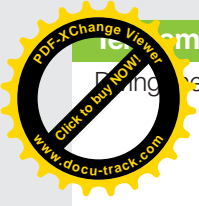

Termometro ad immersione



216 032 Diam. 5 mm - L. 200 mm - 0° - 160° C

Set provaradiatori universale

Universal set for radiator



216 033 In valigetta - Pz 18

Ricambi - Spare-parts



216 033 01 Pompa



216 033 02 Raccordo R-123 - R-124

216 033 03 Raccordo R-123 - R-125



216 033 04 GM Buick-Jeep-Mercedes Peugeot-Subaru-Mazda-Chrysler-Acura-Nissan - GM (Nova-Spectrum-Sprint)-

216 033 05 Mitsubishi-Mazda-Geo - Toyota-Suzuki-Infinity-Isuzu-Ford

216 033 06 Honda - Toyota - Suzuki-Mitsubishi-Chrysler-Acura

216 033 07 Mercedes ML-GM(Achiva-Skylark-Grand Am 1992/ 2002)

216 033 08 Volvo-Saab-Citroen-Renault-Fiat-Sterling-Alfa

216 033 09 Vw(Vento-T4-Passat 1996-Golf-Beetle-Sharan)

216 033 10 Audi(A4-A5-A6)-BMW345-Passat 1997/2002 - Porsche Cayenne

- 216 033 11 BMW
- 216 033 12 Audi - VW
- 216 033 13 Ford-Opel-Land Rover-Jaguar-Mercedes
- 216 033 14 Mercedes Classe C - E - S
- 216 033 15 Ford
- 216 033 16 Mazda M3



216 033 17 Termometro doppia scala °C - F

Set prova-radiatori Universale con attrezzo a depressione per il rapido riempimento dei radiatori

Radiator pressure tester & Vacuum type cooling system



216 034 in valigetta

Note: ideale per mettere in pressione, riempire e pulire.

NOTE



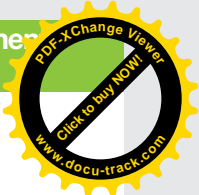
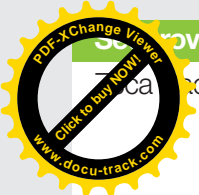

Prova-radiatori Zeca

Radiator tester



216 035 in valigetta - Pz. 18

Ricambi - Spare-parts



216 037 Tappo 416.10 per: Chevrolet - Ford - Opel - Saab - Vw group

216 041 Tappo 416.05 per: Fiat group - Nissan - Mini - Renault - Rover - PSA - Volvo

216 042 Tappo 416.45 Per: Mercedes 1

216 043 Tappo 416.35 per: Vw Group - Porsche

216 050 Tappo 416.40 per: Ford

216 051 Tappo 416.24 per: BMW 2

216 052 01 Tappo 416.85 per: BMW 1

216 052 02 Tappo 416.30 per: Fiat group-Opel-Saab

216 052 03 Tappo 416.65 per: Mercedes 2

216 052 04 Tappo 416.70 per: Fiat - Suzuki - Toyota - Mitsubishi

216 052 05 Tappo 416.80 per: Ford - Mazda - Volvo

216 052 06 Tappo 416.55 per: Smart



216 052 07 Gruppo pompa 416.20



216 044 Tappo 416.66 Ø 40

216 045 Tappo 416.73 Ø 30

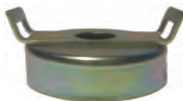

216 046 Tappo metallico Ø 41,5 - 416.75

216 047 Tappo metallico Ø 43,5 - 416.76



216 048 Attacco a baionetta 416.68

Attrezzo a depressione per il rapido riempimento dei radiatori ZECA 417

Cooling device for rapidly radiator filling ZECA 417



216 053

Termometro ad immersione a clip

Diving thermometer



216 055 Diam 25 mm - 250 ° F

Set per scollegare tubi carburante aria condizionata

Set for disconnect fuel and air conditioning pipe



216 058 Ford-Opel - 8 - 9 - 13 - 16 - 19 - 22 mm

Set scollegamento tubi carburante ed impianti di condizionamento

Set of wrench for conditioning and gasoline tubes



216 059 5/16" - 3/8" - 1/2" - 5/8" - 3/4" - 7/8" - 1/4"

Set 4 pz. scollegamento tubi carburante per raccordi angolari

Set of wrench for gasoline connectors



216 060 Alluminio anodizzato - 5/16" - 3/8" - 1/2" - 1/4"

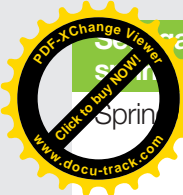

Sganciatori tubi climatizzatori con molle

Spring lock

Spring lock set



216 061 in valigetta

Composizione / Composition

- 4 sganciatori springlock Rosso-Blu-Nero-Bianco
- 4 sganciatori a pinza Rosso-Blu-Nero-Bianco
- 40 springlock (10x) G6 - G8 - G10 - G12

Serie chiavi aperte per dadi impianti condizionamento

Set of wrench for conditioning



216 062 4 pz - 22-24-26-28 mm

216 063 6 pz - 20-22-24-26-28-30 mm

Set universale per impianti di condizionamento

Fuel & air conditioning line disconnect set



216 065 Pz 22

Chiave poligonale aperta per dadi radiatori

Wrench for radiator



216 070 29 mm

Estrattore puleggia climatizzatore Fiat - Alfa - Lancia

Extractor for conditioning pulley Fiat - Alfa - Lancia



216 072 22x1.5

Kit estrazione climatizzatore SANDEN

Kit for clima SANDEN



216 080

Kit per installare e rimuovere climatizzatori

For installation and removing air conditioned

Acciaio Cr. V.



216 081 Valigetta Pz 4

Dati tecnici - Informative

- Bussola con inserto intagliato mm 2.2 Att.1/4"
- Bussola con inserto intagliato mm 3.2 Att.1/4"
- Bussola SW 12 Att.1/4"
- Bussola SW 15 Att.1/4"

Attrezzo universale per valvola ricarica climatizzatori R12 & R134A

Valve core removers and installer R12 & R134A



mm 135

216 082

Blocca perdite totale

Complete leak stop



216 084

Dati tecnici - Informative

- Ideale per risolvere i problemi di perdite sugli evaporatori, condensatori, tubi o-ring e in altri componenti sia in metallo che in gomma. Facile da usare, si inserisce anche a impianto carico
- * Non occlude orifici e valvole d'espansione
- * Non danneggia l'impianto A/C

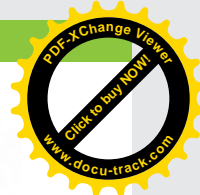

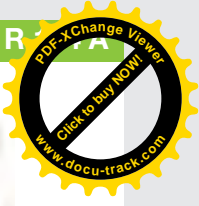

Lampada ricaricabile a raggi UV per la rilevazione delle piccole falle dell'impianto aria condizionata, più 3 potenti led bianchi



216 085

Dati tecnici - Informativi

Tempo di ricarica: 3.5 ore - Autonomia di luce: 3 ore
 Scocca in gomma antiurto e antiolio - Protezione IP 65
 2 caricatori: da muro 220V e accendisigari 12V

Liquido tracciante fluorescente per A/C

Line UV detector dye



216 086 (per 32 dosi) ml 237

216 086 75 (monodose) ml 7,5

Dati tecnici - Informativi

Ideale per rilevare piccole falle dell'impianto aria condizionata degli autoveicoli
 Utilizzato sia nelle stazioni di ricarica sia con iniettore manuale

Olio lubrificante impianti A/C auto

Ester lubricant



216 087 Olio ISO 100 / 1 Lt.

Olio Pag sintetico al 100% specifico per R

PAG oil



216 088 01 Oil ISO 46 - 1Lt

216 088 02 Oil ISO 100 - 1Lt

218 088 03 Oil ISO 150 - 1Lt

Dati tecnici - Informativi

Speciale formula che riduce la corrosione interna e l'usura del compressore.

Chiave ritegno puleggia compressore Denso climatizzatori Fiat Punto

Anti freezer gravity tester



216 090

Tubi in linea con rubinetto e depressore da 1/4" per stazioni di ricarica

1/4" Flexible hoses

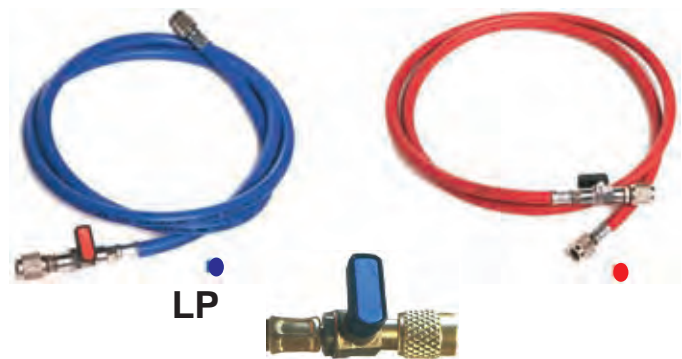

216 092 01 ● Alta pressione - Lungh. 1800 mm

216 092 02 ● Bassa pressione - Lungh. 1800 mm

Attacco rapido con volantino connessione 1/4" SAE

Quick coupler fitted with 1/4" SAE. M connection



216 094 01 ● Rosso - Alta pressione

216 094 02 ● Blu - Bassa pressione

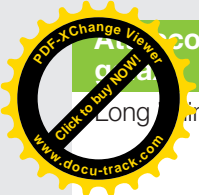

Collegamento rapido lungo per BMW, Volvo, Ford

Long line connection for BMW, Volvo, Ford galaxy



216 094 03 Alta pressione

Demineralizzatore con cartuccia in resina per produrre fino a 100 Lt di acqua



216 150 Demineralizzatore

216 151 Cartuccia in resina

Dati tecnici - Informative

Pressione di alimento: Max 3 bar
Temperatura di alimento: Min.1° - Max 50°C

Densimetro per antigelo con termometro e scala di lettura compensata "Zeca"

Anti freezer gravity tester



216 101 Universale

Densimetro per antigelo

Anti freezer gravity tester



216 102 Universale

Densimetro per antigelo ECOPARAGEL

Anti freezer gravity tester



216 105 Universale

Set chiavi filtro olio - Pz 9

Oil filter wrench set - Pcs 9

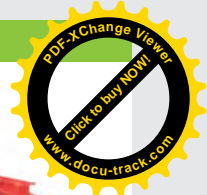

217 000

Composizione - Composition

- 1° Attacco 3/8" Lati 14 Misura mm 64,5 Tacche 3**
utilizzo: Allion, Auris, Corolla axio / fielder / Rumion, Isis, Its, Noha, Premio, Prius, Voxy, Wish
- 2° Attacco 3/8" Lati 14 Misura mm 74,2**
utilizzo: Audi, Bmw, Ford, Mazda, Toyota, Volkswagen, Porsche, Mercedes (tutti i modelli V6 - V8)
- 3° Attacco 3/8" Misura mm 63 / 83**
utilizzo: Chiave filtro olio universale
- 4° Attacco 3/8" Lati 16 Misura mm 86,6**
utilizzo: 335i - 3.0 / 535i - 3.0 / bmw 3 serie (E 90) / X6 - 3.0 / Volvo (1999 - 2006) exc (2005 serie 40 & 50)
- 5° Attacco 3/8" Lati 14 Misura mm 64,5 Tacche 1**
utilizzo: Toyota 2006 (universale) / 2007 & 2008 V6 / Lexus: 2007 ES 350 - GS 350 - GS 450h - LS 460 - RX 350 / Lexus: 2008 LS 600h L
- 6° Attacco 3/8" Lati 15 Misura mm 88,8**
utilizzo: Hyundai / Kia
- 7° Attacco 3/8" Lati 6 Misura mm 27**
utilizzo: Mercedes & Smart
- 8° Attacco 3/8" Lati 6 Misura mm 32**
utilizzo: Opel vauxhall 4 cilindri / GM, 2,2L ecotech X10XE - X12XE - Y17DT - Y17DTL / Mercedes HGV'S e.g - OM 364 - OM 366
- 9° Attacco 3/8" Lati 6 Misura mm 36**
utilizzo: Mercedes OM 604 - OM 605 - OM 606 - Bmw M52 - 6cil. - M60 - 8cil. - M70 - 12cil. - Mini One - Cooper - Coopers - Ford 6Lt. Diesel VW VR6 (maggioranza Pickup)

Chiave filtri olio a fascia

Band wrench for oil filter cartridge



- 217 001 Universale - 80 mm
- 217 002 Universale - 90 mm
- 217 003 Universale - 100 mm
- 217 004 Universale - 110 mm

Chiave filtri olio a fascia

Band wrench for oil filter



- 217 005 Offerta fino esaurimento scorte mm 75 - 80
- 217 006 Offerta fino esaurimento scorte mm 80 - 90
- 217 007 Offerta fino esaurimento scorte mm 90 - 95

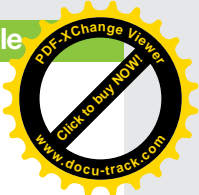
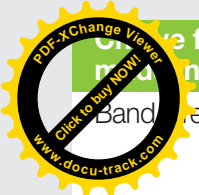

Chiave filtri olio a fascia con manico snodato

Band wrench for oil filter cartridge



- 217 016 Universale - 57-73 mm
- 217 017 Universale - 65-83 mm
- 217 018 Universale - 75-95 mm
- 217 019 Universale - 92-111mm

Chiave filtro olio a fascia con manico snodato

Band wrench for oil filter cartridge



- 217 020 12 Ø 100 - 120
- 217 02014 Per essicatori - Ø 120 - 146

Chiave filtri olio a fascia leggera con manico snodato

Band wrench for oil filter cartridge



- 217 021 Universale - 73-83 mm
- 217 022 Universale - 87-95 mm

Chiave filtri olio a fascia regolabile

Band wrench for oil filter cartridge



- 217 030 Universale - 65-110 mm
- 217 031 Fascia ricambio

Chiave filtri olio ed essicatori a fascia regolabile

Band wrench for oil filter cartridge and truck dry cartridge



- 217 032 Universale - 100-150 mm
- 217 033 Fascia ricambio

Chiave filtri olio a fascia fibra telata regolabile

Band wrench for oil filter cartridge



- 217 037 Universale - 70-110 mm
- 217 038 Fascia ricambio

Chiave filtri olio a fascia regolabile

Band wrench for oil filter cartridge



- 217 039 Universale - 60-190 mm

Chiave filtro olio a fascia alta, universale, ideale per macchine da lavoro

1/2" Strap wrench



- 217 040

Dati tecnici - Informative

Per filtri fino a mm 180
Attacco quadro di manovra 1/2"

Chiave filtro olio dentata con cinghia in cuoio

Band wrench for oil filter cartridge

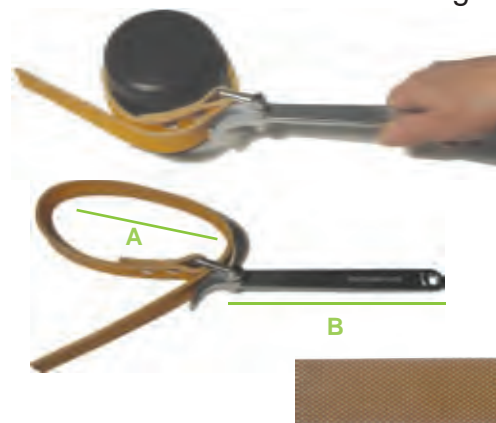

| | A | B | C |
|---------|------------|--------|-------|
| 217 041 | Ø 40 - 160 | mm 180 | mm 20 |
| 217 042 | Ø 40 - 240 | mm 240 | mm 25 |

Ricambi - Spare-parts

- 217 041 01 Cinghia in cuoio per 217 041
- 217 042 01 Cinghia in cuoio per 217 042

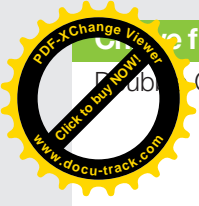

filtri olio a doppia catena sottile

Chain wrench for oil filter cartridge



- 217 051 Universale - 1/4" - 60-120 mm
- 217 052 Catena di ricambio

Chiave filtri olio a doppia catena sottile

Double Chain wrench for oil filter cartridge



- 217 053 Universale - catena da 1/4" - 60-120 mm
- 217 053 01 Universale - catena da 1/4" - 60-160 mm

Ricambi - Spare-parts

- 217 054 Catena per 217 053
- 217 054 01 Catena per 217 053 01

Chiave a catena doppia sottile per filtri olio

Oil filter wrench with double chain

Att. 1/2"



- 217 053 10 Ø 60 - 120
- 217 053 11 Ø 60 - 160

Chiave filtri olio a doppia catena

Double Chain wrench for oil filter cartridge



- 217 055 Universale - 3/8" - 60-120 mm

Ricambi - Spare-parts

- 217 056 Catena di ricambio 58 passi

Chiave filtri olio a catena regolabile

Chain wrench for oil filter cartridge



- 217 057 Universale - 1/2 - 60-120 mm

Chiave filtro a catena doppia

Double chain wrench for oil filter



- 217 058 mm 60 - 160

Ricambi - Spare-parts

- 217 059 Catena di ricambio 88 passi

Chiave filtri olio a banda e catena

Band and Chain wrench for oil filter cartridge



- 217 061 Universale - 80-110 mm

Ricambi - Spare-parts

- 217 061 01 Catena con fascia di ricambio
- 217 061 02 Fascia ricambio senza catena
- 217 062 Catena di ricambio senza fascia

Chiave filtri olio a banda e catena con ingranaggio

Band and Chain wrench for oil filter cartridge with gear



- 217 063 Universale - 1/2" - 80-110 mm

Ricambi - Spare-parts

- 217 064 Catena di ricambio

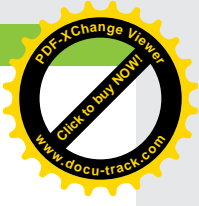

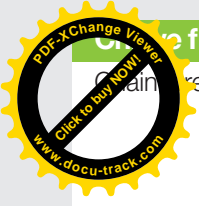

filtri olio a catena con ingranaggio

Chain wrench for oil filter cartridge with gear



- 217 065 Universale - 1/2" - 60-110 mm
- 217 066 Catena di ricambio
- 217 067 Universale - 1/2" - 60-140 mm
- 217 068 Catena di ricambio

Chiave filtri olio a catena regolabile

Chain wrench for oil filter cartridge



- 217 069 Universale - 60-110 mm

Ricambi - Spare-parts

- 217 070 Catena di ricambio

Chiave filtri olio a catena regolabile

Chain wrench for oil filter cartridge



- 217 071 Universale - 60-110 mm

Ricambi - Spare-parts

- 217 072 Catena di ricambio

Chiave filtri olio a doppia catena

Double Chain wrench for oil filter cartridge



- 217 073 Universale - 3/8" - 60-110 mm
- 217 07301 Universale - 3/8" - 60-140 mm

Ricambi - Spare-parts

- 217 074 Cat. ricambio 217 073
- 217 074 01 Cat. ricambio 217 073 01

Chiave a fascia alta resistenza per filtri olio-aria



- 217 078 Ø 105 - 120 Att. 1/2"
- 217 079 Ø 115 - 135 Att. 1/2"
- 217 080 Ø 130 - 145 Att. 1/2"

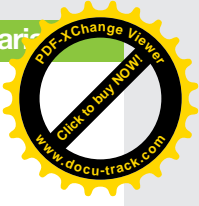

Chiave filtri olio a leva registrabile

Lever wrench for oil filter cartridge



- 217 085 Universale - 75-92 mm

Chiave filtri olio a pinza

Plier wrench for oil filter cartridge



- 217 087 Universale registrabile - 60-90 mm
- 217 088 Universale registrabile - 85-115 mm

Chiave autoserrante reversibile per filtri olio

Reversible filter wrench



- 217 090 Ø 66 - 83

Chiave filtri olio registrabile

wrench for oil filter cartridge



- 217 092 Universale - 85-100 mm

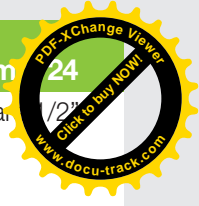
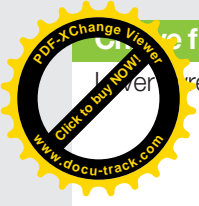

filtri olio registrabile

wrench for oil filter cartridge



217 093 Universale - 80-105 mm

Chiave filtri olio autoserrante

wrench for oil filter cartridge



217 094 Universale - 60-100 mm

Serie chiavi filtri olio registrabili

Set wrenches auto locking for oil cartridge



217 095 Universale - 60-125 mm - Pz. 3

Ricambi - Spare-parts

217 096 Universale - 60-80 mm

217 097 Universale - 80-100 mm

217 098 Universale - 100-125 mm

Chiave a tre zampe bassa per filtri olio

Three low legs key for oil filter



217 099 Ø 60/99



Chiave filtri olio in lamiera di acciaio ad alta resistenza con quadro 1/2" ed esagono da m

Wrench for oil filter cartridge sheet steel with square 1/2" and exagon 24 mm



217 100 Nissan-Opel-Isuzu-Mazda-Mitsubischi - 14 lati - 64 mm

217 102 Mitsubishi - 14 lati - 67 mm

217 104 Fiat - 8 lati - 74 mm

217 106 Mercedes-Bmw - 14 lati - 75 mm

217 107 Fiat Nuova Croma - 16 lati - 75 mm

217 108 Opel - 15 lati - 76 mm

217 110 15 lati - 80 mm

217 112 Fiat - 10 lati - 93 mm

217 116 Fiat - 15 lati - 106 mm

217 118 Fiat -PALIO EXTRASOTTILE - 15 lati - 106 mm

Chiave filtri olio in lamiera di acciaio ad alta resistenza con quadro 1/2" ed esagono da mm 24

Wrench for oil filter cartridge sheet steel with square 1/2" and exagon 24 mm



217 120 Twingo-Opel 1500 D - 6 tacche - 66 mm

217 122 Megane - 12 tacche - 76 mm

217 124 Laguna - 18 tacche - 86 mm

217 126 Peugeot - 45 tacche - 92 mm

217 128 Laguna D - 18 tacche - 96 mm

Serie di chiavi filtri olio in acciaio FIAT- JAPAN

Set of wrenches for oil filter cartridge on steel



217 130 Pz 5

Contenuto - contains

217 100 Nissan-Opel-Isuzu-Mazda-Mitsubischi - Nuova punto - 14 lati - 64 mm

217 102 Mitsubishi - 14 lati - 67 mm

217 104 Fiat - 8 lati - 74 mm

217 112 Fiat Bravo Brava Marea - 10 lati - 93 mm

217 116 Fiat Diesel Iveco - 15 lati - 106 mm



Chiavi filtri olio in acciaio EUROPEE

Wrenches for oil filter cartridge on steel



217 132 Pz 5

Contenuto - contains

- 217 106 Mercedes - 14 lati - 75 mm
- 217 108 Opel - 15 lati - 76 mm
- 217 120 Nuova Twingo- Clio Nouvelle - Opel 1.5D
6 tacche - 66 mm
- 217 122 Megane - Clio - 12 tacche - 76 mm
- 217 124 VAG Tdi - Laguna D - 18 tacche - 86 mm

Chiave filtro olio a tazza lamiera acciaio con attacco 3/8"

Lati



Tacche



- 217 135 Mitsubishi - 14 lati - 65-67 mm
- 217 135 01 14 Lati - 68 mm
- 217 135 02 14 Lati - 73 mm
- 217 135 03 Doppio diametro - 15 Lati - 74 / 76 mm
- 217 135 04 14 Lati - 76 mm
- 217 136 30 Tacche - 76 mm
- 217 136 01 Doppio diametro - 15 Lati - 75 / 77 mm
- 217 136 02 Attacco 3/8" - Lati 15 - mm 78
- 217 137 Mitsubishi-Nissan-Suzuky-Toyota ect
15 lati - 80 mm
- 217 138 Opel - 15 lati - 82 mm
- 217 138 01 Attacco 3/8" - Lati 15 - mm 80 - 82
- 217 138 02 Attacco 3/8" - Lati 16 - mm 86
- 217 139 Fiat - 15 lati - 90 mm
- 217 139 01 36 Tacche - 93 mm
- 217 140 Isuzu - 15 lati - 100 mm
- 217 141 15 lati - 93 mm
- 217 142 15 lati - 108 mm
- 217 143 18 lati - 108 mm

Chiave filtro olio a tazza per MAN

Oil filter key



In lega di Alluminio

Esagono mm 27

Quadro 3/8"



217 144 18 Lati - mm 135

Set 15 pz. chiavi filtro olio a tazza

Set of wrenches for oil filter



217 145 in valigetta

- 14Lati Ø65 Dayatsu - Toyota
- 14Lati Ø68 Mazda - Subaru
- 14Lati Ø73 Toyota
- 15Lati Ø74/76 Fram
- 14Lati Ø76 Mercedes - BMW
- 15Lati Ø80 Nissan - Honda
- 15Lati Ø93 VW - Renault
- 36Tacche Ø93 Motorcraft
- 14Lati Ø65/67 USA - CANADA
- 15Lati Ø80/82 Honda - Mazda
- 15Lati Ø90 Isuzu - Mitsubishi
- 15Lati Ø75/77 GM - Ford
- 30Tacche Ø76 Motorcraft
- 15Lati Ø100 Isuzu - Vix - Holder - M3/8 - F1/2

Set chiavi filtro olio a tazza

Set Oil filter cap wrench



217 146 Att. 3/8" & 1/2" - Valigetta Pz 30

Composizione - Composition

| mm | N° lati | mm | N° lati | mm | N° lati |
|-------|---------|-------|---------|-----|---------|
| 66 | 6 | 76 | 30 | 93 | 36 |
| 65 | 14 | 76 | 8 | 93 | 45 |
| 66-67 | 14 | 78 | 15 | 95 | 15 |
| 68 | 14 | 80 | 15 | 96 | 18 |
| 73 | 14 | 80-82 | 15 | 100 | 15 |
| 74 | 15 | 86 | 16 | 106 | 15 |
| 74-76 | 15 | 86 | 18 | 108 | 15 |
| 75-77 | 15 | 90 | 15 | 108 | 18 |
| 76 | 12 | 92 | 10 | | |
| 76 | 14 | 93 | 15 | | |

Adattatore 3/8" - 1/2"

Ragno mm 65-120

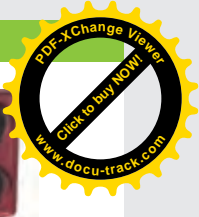

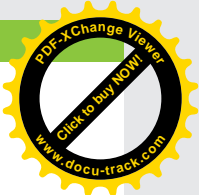
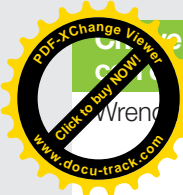

filtri olio in lega leggera PURFLUX cono di manovra da mm. 24

Wrench for oil filter cartridge aluminium with exagon 24 mm



| | | |
|---------|-------------------------------|-------|
| 217 150 | Twingo-Opel 1500 D - 6 tacche | 66 mm |
| 217 152 | Megane - 12 tacche | 76 mm |
| 217 154 | Laguna - 18 tacche | 86 mm |
| 217 156 | Laguna D - 18 tacche | 96 mm |

Chiave filtro gasolio Peugeot - Citroen HD. 2 - 2.2

Fuel filter socket



mm 27

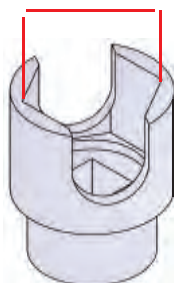

217 167 mm 27

Set chiavi in acciaio per filtri olio ad immersione

Steel set Oil filter cap wrench



217 168 Att. 3/8" - mm: da 24 alla 38 - Pz 7

Composizione - Composition

Att. 3/8" mm 24 - 27 - 29 - 30 - 32 - 36 - 38

Set chiavi per filtri olio ad immersione

Set Oil filter cap wrench



217 170 Att. 3/8" - Pz 3 - in valigetta

Ricambi - Spare

| | |
|------------|-------------------|
| 217 170 01 | Att. 3/8" - mm 27 |
| 217 170 02 | Att. 3/8" - mm 32 |
| 217 170 03 | Att. 3/8" - mm 36 |

Chiavi per filtri olio ad immersione

Set Oil filter cap wrench



| | | |
|------------|-----------|-------|
| 217 170 24 | Att. 3/8" | mm 24 |
| 217 170 27 | Att. 3/8" | mm 27 |
| 217 170 30 | Att. 3/8" | mm 30 |
| 217 170 32 | Att. 3/8" | mm 32 |
| 217 170 36 | Att. 3/8" | mm 36 |
| 217 170 38 | Att. 3/8" | mm 38 |

Chiave filtro olio ricavata da tondo pieno

Acciaio
Cromato



| | | |
|---------|-----------------|----------|
| 217 172 | Fiat - 8 lati | - 74 mm |
| 217 176 | Fiat - 10 Lati | - 92 mm |
| 217 178 | TRUCK - 15 Lati | - 106 mm |

Chiave filtro olio in acciaio saldato con quadro 1 / 2" ed esagono di manovra mm 24

Oil filter wrench solder steel - 1 / 2"



Zincate



| | | |
|------------|-----------------------------|-------------------|
| 217 180 | 14 Lati | - mm 64 |
| 217 184 | Fiat - 08 Lati | - mm 74 |
| 217 185 | 10 Lati | - mm 74 |
| 217 186 | Mercedes-Bmw - 14 Lati | - mm 75 |
| 217 186 01 | Multijet 1.9 - 16 Lati | - mm 75 |
| 217 187 | Opel - 15 Lati | - mm 76 |
| 217 187 06 | 14 Lati | - mm 80 |
| 217 188 | Mitsu...-Niss...-Suz...-Toy | - 15 Lati - mm 80 |
| 217 188 00 | 16 Lati | - mm 87 |
| 217 188 01 | 12 Lati | - mm 88 |
| 217 188 02 | 16 Lati | - mm 90 |
| 217 188 03 | 16 Lati | - mm 92 |
| 217 188 05 | 10 Lati | - mm 90 |
| 217 188 08 | 15 Lati | - mm 90 |
| 217 188 14 | 14 Lati | - mm 84 |
| 217 189 | Fiat Marea TD - 10 Lati | - mm 93 |
| 217 190 | Volvo - 15 Lati | - mm 93 |
| 217 190 05 | 15 Lati | - mm 98 - |
| 217 191 | Iveco - 15 Lati | - mm 106 |
| 217 192 | Isuzu - 16 Lati | - mm 118 |
| 217 193 | 18 Lati | - mm 136 |
| 217 196 | 9 Tacche | mm 92 |
| 217 197 | 9 Tacche | mm 95 |

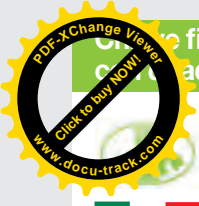

Chiave filtro olio "MODELLO ALTO" in acciaio saldato quadro 1/2" ed esagono di manovra mm 24



217 189 01 10 Lati - 93 mm

Chiave filtro olio in acciaio saldato

Oil filter wrench solder steel



Zincate



217 194 Iveco - Eurocargo

Dati tecnici - Informative

Lati 15 - mm 112,5
Attacco quadro di manovra 1/2"
Esagono di manovra mm 24

Chiave filtri olio a fascia

Band wrench for oil filter cartridge



217 200 Universale - 75 mm

217 201 Universale - 80 mm

217 202 Universale - 98 mm

217 203 Universale - 110mm

217 204 Universale - 140mm

Chiave filtri olio in acciaio

Steel wrench for oil filter cartridge



217 210 Renault Laguna TD - 18 tacche - 108 mm

Chiave filtri olio a tacca con quadro 1/2"

Wrench for oil filter cartridge



217 215

Chiave filtro olio VESPA PIAGGIO 50 CC

Band wrench for oil filter cartridge VESPA PIAGGIO 50 CC



217 220 Quadro manovra 1/2"

Chiave filtri olio TDCI Ford - HDI Citroen - Peugeot

Oil filter wrench on TDCI Ford - HDI Citroen - Peugeot



217 240 Att.1/2" Poligono mm. 27

Dati tecnici - Informative

Chiave per smontare e rimontare il filtro dell'olio montati sui motori 2.0 Duratorq TDCI (HDI DW10C) e 2.2 TDCI Duratorq TDCI (HDI DW 12C) su veicoli Ford - Jaguar - Land rover e motori HDI Citroen - Peugeot.

Set 3 Pezzi per lo smontaggio in morsa del filtro gasolio multijet Fiat e Opel

Set for disassembly multijet filter Fiat & Opel



217 245 Ghiera + Attrezzo Fiat - Kit 2 Pz

217 245 10 Ghiera + Attrezzo Fiat + Attrezzo Opel - kit 3 Pz

Ricambi - Spare

217 245 01 Ghiera di manovra

217 244 Attrezzo filtro gasolio Opel Multijet

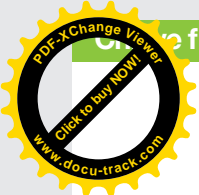

filtra gasolio vetture Peugeot HDI



217 246

Chiave smontaggio filtri olio e gasolio alta in lega di alluminio pressofusa



217 249 Ø 74 - 14 Lati

Chiave aperta per filtro gasolio strumentato

Key for fuel filters



217 250 H=120mm 14 lati - mm75

Chiave filtro a campana pesante



| | Attacco | Lati | mm | Altezza |
|---------|---------|------|-----|---------|
| 217 251 | 1/2" | 15 | 141 | 50 |

Chiave filtro olio alta per Toyota

Alluminio



217 252 14 Lati con 1 tacca mm 64,5

Dati tecnici - Informativa

-Toyota: 207 - 2008 3.5L V6
-Lexus: GS300 (2006), IS250 (2006), IS350 /2006), ES350 (2007) GS350 (2007), GS450 (2007), LS460 (2007), RX350 (2007) LS600h L(2000)

Chiave filtro olio a tazza in alluminio

Wrench for oil filter cup type



217 253 14 Lati con 3 tacche + 3 tacche mm 64,5 Att.3/8"

Toyota 2007 - 2008 V6 / Dal 2006 tutte le Lexus / Dal 2007 ES350 - GS350 - GS450h - LS460 - RX350 / Dal 2008 LS600h

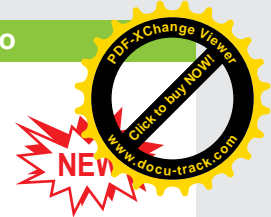

Chiave filtro olio a tazza in alluminio per HYUNDAI & KIA

Wrench for oil filter cup type
100 mm

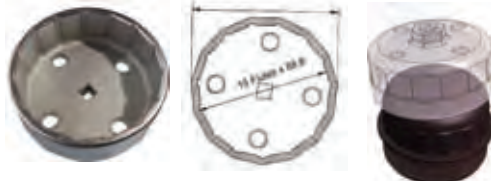

217 254 15 Lati mm 88,8 Att.3/8"

Chiave per manovra bulbo acqua

Wrench for water bulb removal



217 391 29 mm

Chiave ghiera fissaggio filtro olio

Wrench for oil filter nut fixing



217 392 Alfa 155-164 6 denti 34x24x3.5 4 denti 34x26x5

Chiave ghiera fissaggio filtro olio

Wrench for oil filter nut fixing



217 393 Alfa 164 - Polig 22 mm

Chiave ghiera fissaggio filtro olio

Wrench for oil filter nut fixing



217 394 Audi-Polo - 38,5 x 18 x 7

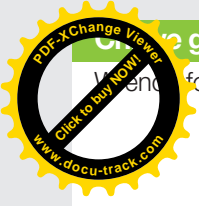

Chiave fissaggio filtro olio

Oil filter nut fixing



217 395 164 TD

Kit riparazione filetto tappo coppe olio

Kit repairing oil filter cups



217 400 12 Tappi con rondelle

Ricambi - Spare

| | Esagono | Esagono femmina | Filetto | Pz |
|------------|---------|-----------------|----------|----|
| 217 400 01 | 17 | ----- | 13 x 1,5 | 1 |
| 217 400 03 | 19 | ----- | 15 x 1,5 | 1 |
| 217 400 05 | --- | 8 | 17 x 1,5 | 1 |
| 217 400 07 | --- | 10 | 20 x 1,5 | 1 |

Kit in astuccio riparazione filetto tappo coppe olio

Kit repairing oil filter cups



- 217 400 13 1 maschio + 12 rondelle + 6 tappi - 13 x 1.5
- 217 400 15 1 maschio + 12 rondelle + 6 tappi - 15 x 1.5
- 217 400 17 1 maschio + 12 rondelle + 6 tappi - 17 x 1.5
- 217 400 20 1 maschio + 12 rondelle + 6 tappi - 20 x 1.5
- 217 400 22 1 maschio + 12 rondelle + 6 tappi - 22 x 1.5

Kit universale riparazione filetto tappo coppe olio

Oil pan repair master set



217 401

Composizione - Composition

| | |
|-----------------------------------|----------|
| 1 maschio + 10 rondelle + 5 tappi | 13 x 1.5 |
| 1 maschio + 10 rondelle + 5 tappi | 15 x 1.5 |
| 1 maschio + 10 rondelle + 5 tappi | 17 x 1.5 |
| 1 maschio + 10 rondelle + 5 tappi | 20 x 1.5 |

Chiave tappo olio monolitica per Audi

Oil cup socket hole XZN
Acc. Cr Mo.
Cromato

Att. 1/2"

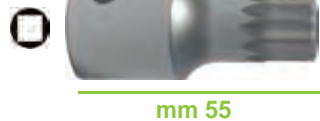

mm 55



217 404 XZN 16 Forata

Bussola con inserto xzn forato per dadi coppa olio

Socket with bit hole xzn for oil cup



217 405 Audi - 16 x 55

217 406 Audi - 16 x 100

Chiave dadi tappo olio

Wrench for oil draining plug



217 412 Fiat - 12 mm

Chiave dadi tappo olio

Wrench for oil draining plug



217 413 Fiat - 12 mm

Chiave quadra dadi tappo olio

Wrench square for oil draining plug



217 415 Ford - 11-12 mm

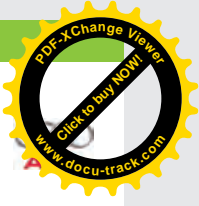

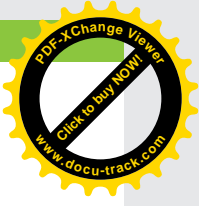
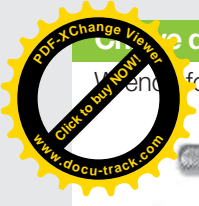

Chiave dadi tappo olio

Wrench for oil draining plug



- 217 416 Quadro 8 mm
- 217 416 01 Quadro 9 mm
- 217 417 Quadro 10 mm

Chiave dadi tappo olio sezione triangolare

Wrench for threangle oil draining plug



- 217 418 Triangolare 10 mm

Chiave dadi tappo olio con doppio quadro

Double wrench for oil draining plug



- 217 420 Quadro 8-9 mm
- 217 421 Quadro 8-10 mm

Chiave dadi tappo olio con doppio esagono

Double wrench for oil draining plug



- 217 423 Audi-Volkswagen 14-17 mm

Chiave doppia dadi tappo olio e cambio

Twin wrench for oil draining plug and gear



- 217 425 M 10 mm - F 10 mm
- 217 426 M 8 mm - F 6 mm

Set chiavi tappo olio

Set of oil draining plug wrenches



- 217 430 Quadro 8-3/8"-10-11-13
Esagono 5/16"-8-10-3/8"-12-14

Set chiavi tappi olio

Set oil draining plug wrenches



- 217 431 Att 1/2" - Pz 21

Composizione - Composition

- mm6 - 7 - 8 - 10 - 11 - 12 - 13 - 14 - 5/16 - 3/8"
- mm 8 - 9 - 10 - 12 - 13 - 14 - 17
- Tx10 - Tx45 mm16
- Quadro femmina mm10 - 1 asta con quadro 1/2"

Chiave quadra dadi tappo olio

Tank opener



- 217 440 Universale

Imbuti per travaso olio motore Fire (compatibili con prolunga)

Wrench for lambda sensor (mm 22)



- 217 441 Imbuto circolare corto per taniche da 1 litro
- 217 442 Imbuto quadrato corto per taniche da 4 litri
- 217 441 01 Imbuto circolare lungo per taniche da 1 litro
- 217 442 01 Imbuto quadrato lungo per taniche da 4 litri

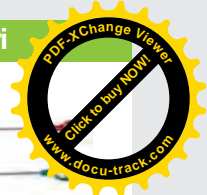
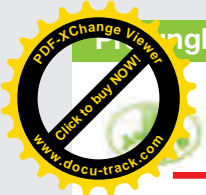

linghe filettate (compatibili con prolunga)



- 217 443 Prolunga filettata per imbuti Fire
- 217 444 Prolunga filettata per imbuti Fire su vetture Multijet
- 217 447 Prolunga filettata per Multiair e EVO 2

Prolunga flessibile per imbuti travaso olio motore Fire da utilizzare su furgoni e vetture Multijet con tappo olio in profondità



217 446 Lunghezza mm 470

Prolunga flessibile + Prolunga filettata per motori Multiair



217 447 01 Lunghezza mm 510

Imbuto olio lt. 2.2 con sistema anti-reflusso

Made in Germany



217 445 Motori Audi - Seat - Skoda - Vw - Etc

Kit astine controllo olio trasmissione motori

Mercedes transmission oil dipstick set



217 454 Pz 4

Ricambi - Spare-parts

- 217 450 Per cambi tipo: 722.6 - mm 1220
- 217 451 Per cambi tipo: 722.7 / 716.5 - mm 920
Per cambi tipo: 103-943 / 984 / 985-104-111-119-120-137-603-913 / 963 / 97-604-605-606-611-612-613-626 - mm 930
- 217 452 Per cambi tipo: 112-113-646-647-648 - mm 930

Asta rilevamento livello olio Audi A4 & A5

Audi transmission oil dipstick Audi A4 & A5

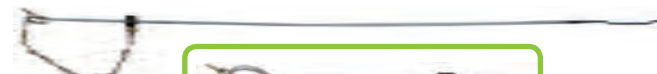

217 459 NB: La misurazione deve essere effettuata con una temperatura dell'olio di circa 60°

Astina controllo olio cambio Audi 100

Audi 100 oil dipstick



217 460 L= mm 520

Chiave per lo smontaggio sonda temperatura su motori Freemont 2.0 - 140cv Mg



217 485

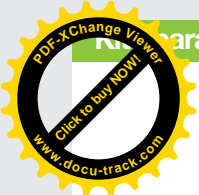

Parazione filetti sonda lamda



217 490 M18x1.5

Chiave per sonda lambda

Wrench for lambda sensor



Att: 1/2"

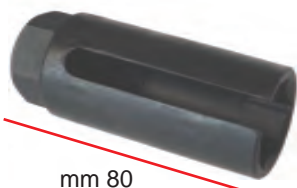

Esagono mm 29

1/2"

217 493 Esagono mm 29

Chiave bussola snodata, aperta, doppia impronta, con impugnatura piegata

Angled socket 22 mm hex



Impronta Poligonale mm 22

Impronta Esagonale mm 22

217 495 Per sonda lambda - mm 22 x 250

Chiave sonda lambda pesante con doppio quadro di manovra



217 496 1/2" - 22 mm

Kit bussole per sonda lambda (mm 22)

Wrench for lambda sensor (mm 22)



217 497 Pz 5

Composizione - Composition

| | Attacco quadro | Lunghezza | Esagono |
|----|----------------------------|-----------|---------|
| 1° | 1/2" | mm 150 | mm 22 |
| 2° | 1/2" | mm 80 | mm 22 |
| 3° | 1/2" | mm 48 | mm 22 |
| 4° | 3/8" | mm 30 | mm 22 |
| 5° | Ravviva Filetti M 18 x 1,5 | | |

Chiave manovra sonda lambda con doppio quadro

Wrench for dismantling Lambda sensor



217 498 1/2" - 22 mm

217 503 3/8" - 22 mm

Chiave poligonale manovra sonda Lambda

Wrench for dismantling Lambda sensor



217 499 Corta 1/2" - 20x78 mm

Chiave manovra sonda Lambda

Wrench for dismantling Lambda sensor



217 500 Corta 3/8" - 22x80 mm

217 501 Corta 1/2" - 22x80 mm

217 502 Lunga 1/2" - 22x120 mm

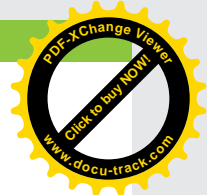

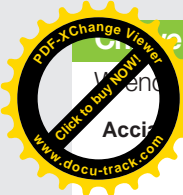

Chiave per sonda lambda extralunga - Impact

Wrench for dismantling lambda sensor - Impact

Acciaio Cr. M



Att. 1/2"

217 502 15

mm 150

Chiave manovra sonda lambda con doppio quadro

Wrench for dismantling Lambda sensor



217 498 1/2" - 22 mm

217 503 3/8 - 22 mm

Chiave poligonale manovra sonda Lambda

Wrench for dismantling Lambda sensor



217 504 20 mm

Attrezzo per smontaggio molle ritegno tubo di scarico

Tool for removing spring of manifold and muffler pipe



217 505 Golf-Passat

Tagliamarmitte regolabile per tubi di scarico

Cutter for muffler pipe
in esaurimento



217 507 Universale - 19-76 mm

Ricambi - Spare parts

217 508 Catena

Utensile allargatubi marmitte catalitiche

Tool for pipe muffler opening

Utilizzare avvertore per espansi



217 509 Universale - 41-62 mm

Utensile allargatubi marmitte

Tool for pipe muffler opening



217 511 Universale - 22-40 mm

217 513 Universale - 38-62 mm

217 515 Universale - 54-84 mm

Ricambi - Spare parts

217 512 Segmento - 217 511

217 514 Segmento - 217 513

217 516 Segmento - 217 515

217 517 Perno completo - 217 511

217 518 Perno completo - 217 513

217 519 Perno completo - 217 515

Attrezzo per lo stacco dei tubi di scarico

Tool off pipes

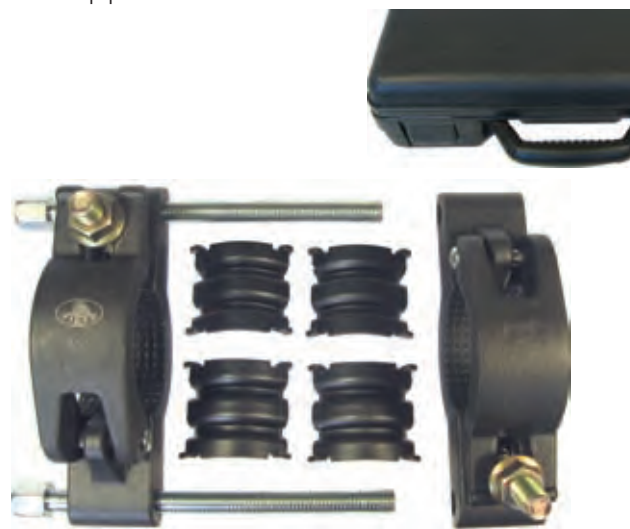

217 525 in valigetta

Chiave a gancio per gommini sostegno tubi scappamento

Wrench for holding muffler pipe rubbers



217 529 Volkswagen-Audi-Mercedes-Nissan-Fiat-Opel

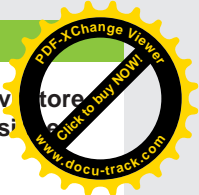

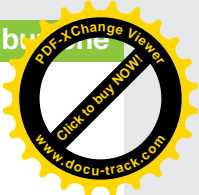
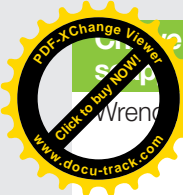

Chiave a gancio corta per gommini sostegno tubi scappamento

Wrench for holding muffler pipe rubbers



217 530 Volkswagen-Audi-Mercedes-Nissan-Fiat-Opel

Chiave a gancio corta per gommini sostegno tubi scappamento

Wrench for holding muffler pipe rubbers



217 531 Ford-Bmw

Kit per smontaggio / montaggio catene

Chain cutter & riveting tool suitable

Smontaggio Montaggio



218 000

Dati tecnici - Informative

*Il kit è indicato lo smontaggio / montaggio catene delle moto, ma si rende praticamente adatto a tutti i tipi di catene essendo dotato di 3 perni intercambiabili di diverso diametro



Ø 3,5 - Ø 5 - Ø 6

Attrezzo smonta / monta catene

Disassembling / assembling chains tool



700 180

Dati tecnici - Informative

Con viti a puntale e viti a punta conica per allargare il piolo forato
Il set è composto di punzone rivettatore per catene RIF: 415 - 420
- 428 - 520 - 525 - 530 - 532

Attrezzo smonta / monta catene di distrib

Disassembling / assembling chains tool



700 185

Attrezzo centrafrizione universale

Universal tool for centering clutch



221 001 Universale

Attrezzo centrafrizione universale

Universal tool for centering clutch



221 005 Universale

Ricambi - Spare parts

221 006 Perno Piccolo

221 007 Perno Medio

221 008 Perno Grande

Attrezzo centrafrizione universale

Universal tool for centering clutch



221 010 Universale

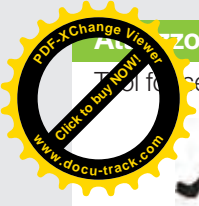

Strumento per il montaggio seeger reggispinta frizione

Tool for seeger clutch



221 031 VALEO

Estrattore volano frizione

Puller for clutch



221 032 Innocenti Mini

Molle per montaggio gruppo frizione

Springs for refitting clutch



221 040 Opel Kadett-Astra

Chiave poligonale per dado fissaggio albero primario cambio Ford Transit

Key for trasmission gearbox Ford transit

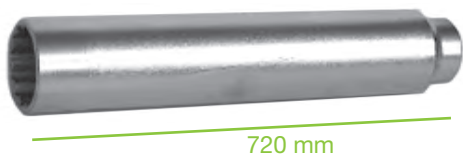

720 mm

221 045 Att. 3/4 - 46 mm

Set montaggio frizione Luck e Sac

Self adjusting clutch tool set (3 hole pitch)



221 048 in scatola
Completo di 3 serie di perni per renderlo adatto a quasi tutti i veicoli;
Audi-Bmw-Mercedes-Opel-Renault-Volvo- Vw- ecc...

Ricambi - Spare parts

221 04901
Ø6



221 04902
Ø7



221 04903
Ø8



221 049 01 Set 3 perni Ø6
221 049 02 Set 3 perni Ø7
221 049 03 Set 3 perni Ø8

Set montaggio frizione Luck e Sac

Self adjusting clutch tool set (3 hole pitch)



221 04901
Ø6



221 04902
Ø7



221 04903
Ø8



221 049 Completo di 3 serie di perni per renderlo adatto a quasi tutti i veicoli; Audi-Bmw-Mercedes-Opel-Renault-Volvo- Vw- ecc...

Ricambi - Spare parts

221 049 01 Set 3 perni Ø6
221 049 02 Set 3 perni Ø7
221 049 03 Set 3 perni Ø8

Kit per montaggio frizioni Sac - Luk (3 / 4 fori)

Self adjustin cluth tool set (3 And 4 hole pitch)



221 050 Kit in valigetta
Adatto a quasi tutti i veicoli; Audi-Bmw-Mercedes-Opel-Renault-Volvo-Vw ecc... Per alcuni veicoli che montano frizioni a 4 fori tipo Mercedes classe A, il kit comprende anche l'attrezzo a 4 staffe con i suoi relativi perni.



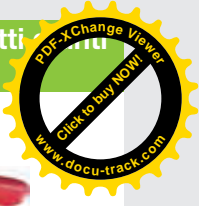
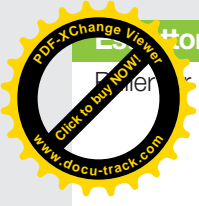

221 051 Peugeot

clutch



221 051 Peugeot

Estrattore volano frizione

Puller for clutch



221 052 Peugeot 404

Minipinza per seeger senza fori per accessi difficili

Mini-plier for seeger without holes



221 054 50 mm

Pinza anelli elastici senza fori su cuscinetti giunti omocinetiche e cambio beccuccio piegato

Plier for ring without hole



221 055 Fiat-Iveco Fuller

Pinza anelli elastici senza fori montati su giunti omocinetiche e cuscinetti cambio. Becchi diritti

NUOVO MODELLO



mm 215

221 055 01 Fiat-Iveco Fuller

Pinza anelli elastici senza fori su cuscinetti omocinetiche e cambio beccuccio diritto



221 056 Fiat - Iveco fuller

Pinza anelli elastici senza fori su cuscinetti giunti omocinetiche e cambio beccuccio piegato



221 057 Fiat - Iveco fuller

Pinza per anelli elastici senza fori in acciaio forgiato manici plastificati

Plier for elastic rings without holes



221 058 Punta rette - 220 mm

Pinza per anelli elastici senza fori in acciaio forgiato manici plastificati

Plier for elastic rings without holes



221 059 Punta angolate - 220 mm

Estrattore perno frizione DUCATO 2.8 JTD

Joint clutch puller for DUCATO 2.8 JTD



221 060 L=120mm

Attrezzo estrazione cuscinetto spingidisco per frizione Ducato

Joint clutch puller - Ducato



221 070

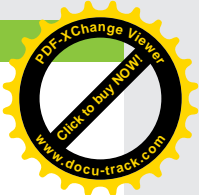
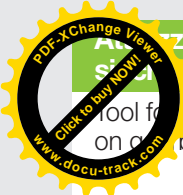

Attrezzo per montaggio anelli elastici di ritegno sincronizzatori albero secondario

Tool for compressing washers for replacing circlips
on gearbox mainshaft



- 222 001 Fiat 131-Aregnta-Campagnola
- 222 002 Fiat 128-Ritmo-127 1050-Delta

Attrezzo per montaggio anelli elastici di ritegno sincronizzatori albero secondario

Tool for compressing washers for replacing circlips
on gearbox mainshaft



- 222 003 Fiat 127-Uno 45/55
- 222 004 Fiat 131-132-Campagnola
- 222 005 Fiat Panda 45

Estrattore leva comando marce

Gearbox lever



- 222 006 Alfa Sud-33-33 4x4

Attrezzo ritegno innesto 2° velocità durante la misurazione pignone corona

Tool for stopping 2° gear for measuring



- 222 010 N 500

Spessore registro posizione leva comando cambio di velocità

Tool for adjusting position of gear lever



- 222 011 N 500

Chiave per registro marce

Wrench for adjusting gear march



- 222 012 Golf

Calibro per leva cambio

Caliper for gear lever



- 222 013 Golf 5 Marce

Chiave ghiera alberi cambio

Wrench for gear shaft nut



- 222 014 Ulisse - Ducato - Scudo - 44x41x5

Chiave ghiera fissaggio albero cambio

Wrench for gear shaft nut



- 222 015 Ducato

Chiave ghiera fissaggio albero cambio

Wrench for gear shaft nut



- 222 017 Daily - diam. 40 mm
- 222 018 Daily - diam. 44 mm
- 222 019 Daily - 48 x 42 x 5

Chiave per dado albero primario

Wrench for gear main shaft nut



- 222 020 Alfetta - 30 mm

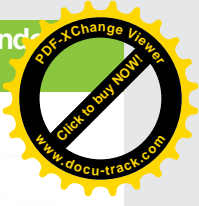
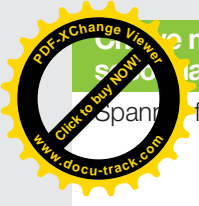

Manovra dado pignone conico albero secondario

Spanner for bevel pinion layshaft retaining nut



222 021 Fiat 242 - 36 mm

Chiave ghiera cuscinetto semiscatola albero secondario

Wrench for half gearbox bearing nut



222 022 Fiat 242

Chiave ghiera cuscinetto semicalotta esterna riduttore

Wrench for auxiliary bearing nut



222 023 Fiat 242

Chiave ghiera albero riduttore

Wrench for low Pto ring nut



222 024 Fiat 242 - 44 mm

Estrattore ingranaggio del cambio 5° marcia su motori Ford

5° Gear extractor Ford engine



222 030

Coppia attrezzo smontaggio boccole comando cambio

Wrench for auxiliary bearing nut



222 200 Alfa - Citroen - Fiat - Lancia - Peugeot - Toyota

Attrezzo ad espansione per smontare anello di ritengo assale

Tool for dismounting retaining axle ring



223 001 GM-FWD-Daily

Battitoio montaggio cuscinetto stagno su semialbero

Device for refitting bear ring on half shaft



223 002 N 500

Chiave a ghiera per smontaggio differenziale della Fiat Panda 4 x 4

Wrench for dismounting Fiat Panda differential



Att. 1/2"

| | Ø Est | Ø Int | Dente | Att. |
|-----------|-------|-------|------------------|------|
| 223 003 | 51 | 45 | h7 x 5 x spess.3 | 1/2" |
| 223 00301 | 55 | 47 | h7 x 5 x spess.4 | 1/2" |

Battitoio montaggio cuscinetto stagno su semialbero

Device for refitting bear ring on half shaft



223 004



223 005



223 004 Diam. Est. 34 mm - Diam. Int. 30 mm

223 005 Diam. Est. 34 mm - Diam. Int. 28 mm

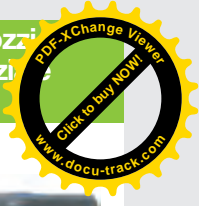
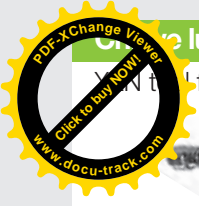

Chiave lunga per differenziale VW - AUDI

for shuft nut



- 223 006 01 XZN mm 08x800
- 223 007 XZN mm 10x500
- 223 007 01 XZN mm 10x800

Chiave esagonale maschio

Wrench male for nuts



- 223 011 8x500 mm

Set chiavi XZN Corte e Lunghe con innovativo attacco

Duo-Drive

- M 18 x 40
- M 16 x 40
- M 14 x 40



Att. 1/2"



Hex mm 24

- M 18 x 60
- M 16 x 60
- M 14 x 60

- 223 013 01 Valigetta Pz 6

Set chiavi XZN Corte e Lunghe con innovativo attacco

Duo-Drive

Made in Germany

- M 12 x 60
- M 14 x 60
- M 16 x 60
- M 18 x 60



- M 12 x 40
- M 14 x 40
- M 16 x 40
- M 18 x 40



Att. hex mm 24



Att. 1/2"

- 223 014 Valigetta Pz 8

Chiave a bussola con maschio XZN per mozzi VW e Audi, e per coperchio scatola differenziale Audi A3 - Vw Touran

XZN tool for shuft nut



Att. 1/2"

Acciaio Cr. Molibdeno



mm 78

- 223 015 Att. 1/2" tipo impact - M 18x78
- 223 016 Att. 1/2" tipo impact - M 16x75

Chiave a bussola con maschio XZN per mozzi VW e Audi, e per coperchio scatola differenziale Audi A3 - Vw Touran

XZN tool for shuft nut



Acciaio Cr. Molibdeno



Att. 3/4"



M18

mm 70

- 223 015 02 Att. 3/4" - Tipo impact - M 18 x 70

Chiave per ghiera a 4 denti rimozione ghiera flangia albero trasmissione Mercedes e AR



- 223 018 Att. 1/2" - 40x35x7,5

Chiave ghiera bloccaggio mozzo giunto differenziale

Spanner to lock inboard constant velocity pinion flange ring nut



- 223 019 Panda 4x4 interna 42x35x55
- 223 020 Lancia Beta - 44 x 35 x 6

Chiave ghiera flangia cambio al pignone

Wrench for shaft nut to pinion



- 223 021 Mercedes transporter - 43 x 36 x 8
- 223 022 Mercedes - 43 x 36 x 5
- 223 024 Mercedes - 34 x 25 x 8

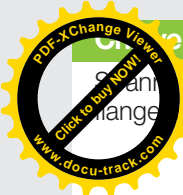

Chiave ghiera bloccaggio mozzo giunto differenziale

Spanner to lock inboard constant velocity pinion retaining nut



223 029 R4-R5

Chiave ghiera bloccaggio mozzo giunto differenziale

Spanner to lock inboard constant velocity pinion flange ring nut



223 030 R 12-R16-R17-R18-Fuego-R5 Alpine

Chiave ghiera bloccaggio flangia di trascinamento giunto omocinetico

Spanner to lock inboard constant velocity



223 031 Beta-Gamma - 63 x 45 x 8

Chiave ghiera bloccaggio flangia sede giunto scorrevole lato propulsore

Spanner for coupling flangering nut, engine side



223 032 Lancia Flavia-Fulvia - 61 x 51 x 7

Chiave ghiera registrazione cuscinetto differenziale

Spanner for adjusting differential nut



223 033 Fiat 126

223 034 Panda 30

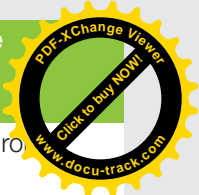

Attrezzo trascinamento corona differenziale per controllo coppia di rotolamento e gioco di accoppiamento pignone corona

Tool for drag differential gear for checking bearing rotation torque and clearance between pinion and gear



223 036 Panda 30

Chiave ghiera ritegno cuscinetti scatola esterna differenziale

Wrench for extern ball bearing box retaining nut



223 037 Panda 30 Nuova 500 - 54 mm

Chiave ghiera cuscinetti semiassie intermedio

Wrench for internal axle differential



223 042 ALFA 155 - 43 x 35 x 6.

Fermo dado pignone differenziale

Tool retaining nut differential pinion



223 045 Alfa Giulia

Chiave per ghiera cuscinetto e ingranaggio contachilometri albero differenziale

Puller of speedometer pinion and nut



223 047 Alfa Sud

Estrattore introduttore albero giunto omocinetico

Introducer for half shaft constant velocity joint



223 051 Alfa 33-155

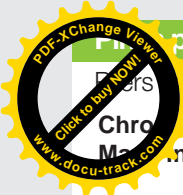

Pinze per seeger senza fori giunti omocineticici

Pliers for seeger omocinetic joint

Chrom Vanadium
Made in Germany

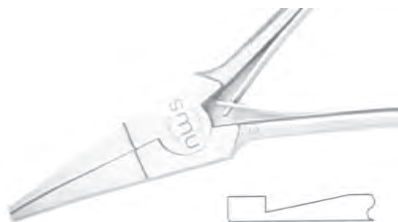

223 052 01 mm 170

Set 3 pinze anelli senza foro su giunto omocineticico

Set 3 plier for circlips without hole for half shaft



Becco dritto

Becco 30°

Becco 60°



223 052 10 Pz 3

Pinza fascette cuffie giunti omocineticineticico

Plier for circlips joint



223 053 Fiat 127-127-Ritmo 65/70-Uno

223 054 Alfa 164

223 055 Uno-Turbo-Regata 100s-Croma-Punto

223 056 Thema

Forcella a leva per estrazione semiassi

Rubber for axle



223 058 Nuova Punto

223 060 Ducato

Cono per introduzione cuffie su semiassie

Installer for rubber on axle



223 061 Citroen AX-Visa - 56 mm

223 062 Renault-Citroen - 58 mm

223 063 Twingo-R9-R11-R5 Super - 67 mm

223 064 R21-R25-Trafic - 70 mm

223 065 Peugeot 205 - 79 mm

223 066 Citroen BX-CX-405-505 - 92 mm

Cono per introduzione cuffie su semiassie

Installer for rubber on axle



223 070 Citroen AX-Visa-Citroen-Renault 23 - 102 mm

Attrezzo pneumatico universale per montaggio cuffie

Universal pneumatic tool for mounting rubber seals

BOOTSLIDER



223 090 Press. max 8 bar per cuffie orig. "BOOGE" 2.5 Kg

Cono per inserimento cuffie elastiche

Cone for mounting rubber on axle



223 103 Universale

Cuffia universale per giunti omocineticici con kit di montaggio

Universal kit seal with cone



223 104 **Composizione:** 1 Cono - 1 Cuffia - 2 fascette - 1 Grasso

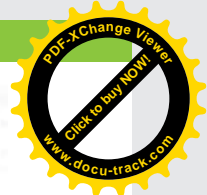

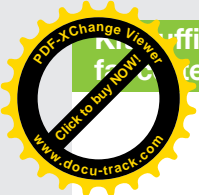

Cuffia elastica universale con grasso e



223 105 con fascette e grasso

Attrezzo serraggio fascette a nastro



223 109 Per fascette mm 5 e mm 8

Attrezzo per fascette a nastro

Tool for circlips



223 110

Attrezzo per fascette a nastro

Tool for circlips



223 111

Rotolo fascette per serraggio cuffie. Custodia in plastica-fermagli

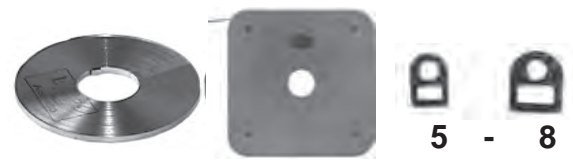

- 223 112 01 Rotolo con custodia - mm 5x50 mt
- 223 113 01 Rotolo con custodia - mm 8x25 mt
- 223 114 01 Custodia vuota - Per 223 112 e 223 113
- 223 115 Sacchetto Fermagli - mm 5 100 pz.
- 223 116 Sacchetto Fermagli - mm 8 100 pz.

Kit fascette a rotolo per giunti omocinetic

Set band for transmission



- 223 120 1 Rotolo fascetta mm 5 x mt 50 in astuccio + 100 Fermagli mm 5 + 1 Pinza
- 223 121 1 Rotolo fascetta mm 8 x mt 25 in astuccio + 100 fermagli mm 5 + 100 fermagli mm 8 + 1 Pinza + 1 Rotolo fascetta mm 5 x mt 50 in astuccio

Ricambi - Spare-parts

- 223 111 Pinza per fascette a nastro
- 223 112 01 Rotolo con astuccio mm 5 x mt 50
- 223 113 01 Rotolo con astuccio mm 8 x mt 25
- 223 114 01 Astuccio vuoto x rotoli mm 5 / mm 8
- 223 115 Confezione 100 fermagli mm 5
- 223 116 Confezione 100 fermagli mm 8

Avendo rinnovata la linea di produzione dei rotoli fascette per serraggio cuffie giunti omocinetic, a partire dai futuri ordini i rotoli fascette saranno forniti esclusivamente con la relativa custodia. Questo agevolerà il lavoro degli operatori, i quali non avranno più problemi di srotolamento della fascetta a operazione conclusa. NB: Al primo uso la protezione posta sulla custodia andrà tolta, per la successiva operazione basterà piegare il terminale del rotolo.

- Prezzi inalterati
- Vogliate gentilmente rilevare la nuova codifica

Attrezzo inserimento corteco differenziale cambio F17 su nuova Cromo e Alfa 159

Tool for differential clutch F17 on Cromo & Alfa 159



223 125

Chiave ghiera differenziale cambio F17 su nuova Cromo e Alfa 159

Wrench for differential clutch F17 on Cromo & Alfa 159



223 130

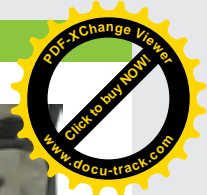

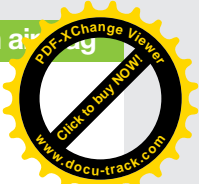
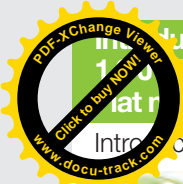

**Estrattore cuscinetto differenziale per Alfa 159
8V/16V, motore Alfa 1858 bz e 2.2 DDI,
Fiat nuova Croma 8V/16V JTD**

Introduttore per bearing differential



223 135

Coppia perni stacco gruppo airbag su volante Fiat

Doblò - Fiorino - Nuova Punto - Qcubo - Idea



230 000

Set estrattore Air bag Vw

Air-bag removal tool Vw



231 000

Per: Polo - Lupo / New Beetle / Seat / Skoda Fabia
- Octavia - Bora AB Bj 1999 / Golf 4 Bj 1998-2004
/ Passat B5 - Passat Ab Bj 1997-2000 / Bmw -
Mercedes (Nuovi modelli)

Estrattore volante di guida

Steering wheel puller



231 001 Opel

Estrattore volante di guida

Steering wheel puller



231 002 Alfa universale - 8x1.25 6x1

Kit 2 estrattori corto e lungo per volante con airbag



231 004 In valigetta

**Chiave a bussola con inserto Torx Forato per Airbag
VW - Audi**

Wrench socket Torx with hole for Air-bag



mm 300

231 004 30 30 x 300 - Att. 1/2"

Estrattore volante di guida

Steering wheel puller



231 006 Suzuki SJ410-Carry

Estrattore volante di guida

Steering wheel puller



231 007 Mini Minor

NOTE



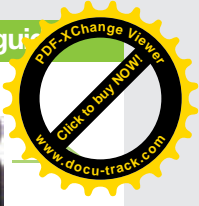
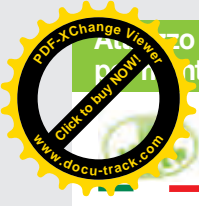

**Strumenti a rulli autoserranti interni di nuova esecuzione
Montaggio / smontaggio braccetti sterzo**

Acciaio

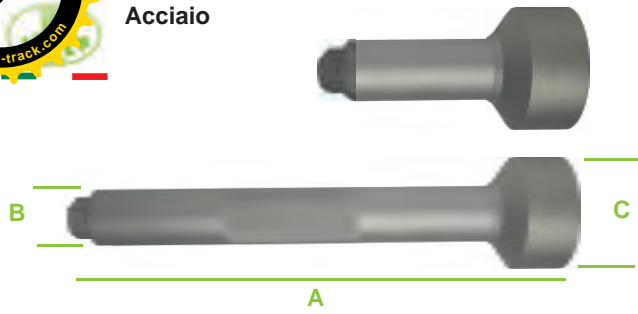

“Universale”

| | Serraggio | A | B | C |
|------------|-----------|--------|------|------|
| 231 008 | Ø 35 - 45 | mm 400 | Ø 45 | Ø 90 |
| 231 008 01 | Ø 35 - 45 | mm 195 | Ø 45 | Ø 90 |
| 231 008 05 | Ø 28 - 35 | mm 400 | Ø 45 | Ø 72 |
| 231 008 06 | Ø 45 - 50 | mm 400 | Ø 40 | Ø 88 |

231 008 08 Specifico per Daily New

Attrezzo rimozione braccetto sterzo

Puller for steering arms



231 009 Foro Ø 20 - Manovra 1/2"

Chiave ghiera servosterzo

Wrench steering slave nut



231 010 Mercedes 190 - 60x54x8

Chiave per tensionare cinghia servosterzo

Wrench for nut pulley of steering slave



231 011 Alfa Romeo - 13 mm

Livella telescopica per regolazione volante guida

Extension level for steering wheel regulation



231 015

Chiave 10 punti femmina per rimozione viti di fissaggio bracci posteriori su Honda CR-V

10 Point impact socket-20mm size: 1/2"DR

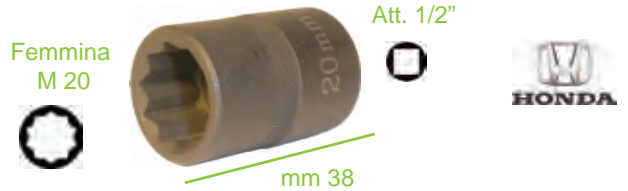

231 020 L = mm 38 - M20

Attrezzo rotazione alberi

Tool for rotation steering arms



231 100 3/8 - 36 mm

231 101 3/8 - 41 mm

Chiave rotazione alberi

Excentric clamp for turning/fixing ball joint

Made in Germany



231 102 Inserimento (A) mm 50

Chiave rotazione alberi

Multi-purpose inner tie rod tool

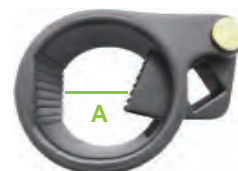

231 103 Apertura Max (A) mm 42

231 107 Apertura Max (A) mm 40 - 47

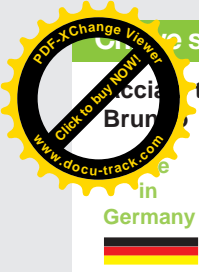

Smontaggio-serraggio braccetti mozzi

temprato -



| | A | B | Att. | |
|---------|----|----|------|------|
| 231 113 | 90 | 13 | 1/2" | Vw |
| 231 114 | 90 | 14 | 1/2" | Audi |
| 231 117 | 90 | 17 | 1/2" | Opel |

Chiave smontaggio-serraggio braccetti mozzi

Made in Germany



| | | | |
|---------|----------|---------|----------|
| 231 120 | mm 12-13 | 231 122 | mm 21-22 |
| 231 121 | mm 19-20 | | |

Estrattore introduttore cuscinetto mozzo posteriore

Introducer ball bearing rear puller



232 004 Alfetta-164

Battitoio smontaggio mozzo anteriore

Introducer of front hubs



232 005 127-128-Ritmo-Panda A112

Perni per estrazione mozzo per art. 221 032

Pins for hubs for item 221 012



232 007 IM3.

Battitoio smontaggio mozzo anteriore

Puller of front hubs



232 008 Alfa sud

Battitoio montaggio mozzo anteriore

Introducer of front hubs



232 009 Alfa sud

Estrattore universale per mozzi auto e furgoni con interasse viti o prigionieri max Ø120 mm



Nuova prolunga per vite inclusa

232 010 Vite con filetto a sezione trapezoidale

Vite idraulica



232 010 11 8 Ton

Note: vite idraulica di grande portata utilizzabile su nostro articolo codice 232 010 solo su richiesta.



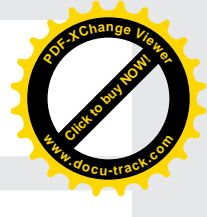

Strattore universale per furgoni in pratica metallica

Universal tool for hubs



232 010 50 Piastra - Vite - 3 serie di colonnette M/F Pz17

*Il Kit viene fornito con 3 serie di colonnette:

232 01055 Maschio Ø 16 x 1.5 / Femmina Ø 14 x 1.5 Pz 5

232 01056 Maschio Ø 16 x 1.5 / Femmina Ø 16 x 1.5 Pz 5

232 01057 Maschio Ø 16 x 1.5 / Femmina Ø 18 x 1.5 Pz 5

in alternativa e senza sovrapprezzo possiamo fornirlo con le tre serie di colonnette Maschio - Maschio su vostra indicazione

Ricambi - Spare-parts



232 010 51 Piastra



232 010 52 Vite



232 010 55 M Ø 16 x 1.5 / F Ø 14 x 1.5 - Pz 5

232 010 56 M Ø 16 x 1.5 / F Ø 16 x 1.5 - Pz 5

232 010 57 M Ø 16 x 1.5 / F Ø 18 x 1.5 - Pz 5

Adattatori opzionali - Optional adaptor



232 010 54 M Ø 16 x 1.5 / F Ø 12 x 1.5 - Pz 5

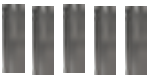

232 010 60 F Ø 16 x 1.5 / F Ø 14 x 1.5 - Pz 5

232 010 61 F Ø 16 x 1.5 / F Ø 16 x 1.5 - Pz 5

232 010 62 F Ø 16 x 1.5 / F Ø 18 x 1.5 - Pz 5



232 010 63 M Ø 16 x 1.5 / M Ø 12 x 1.25 - Pz 5

232 010 64 M Ø 16 x 1.5 / M Ø 12 x 1.75 - Pz 5

232 010 65 M Ø 16 x 1.5 / M Ø 14 x 1.5 - Pz 5

232 010 66 M Ø 16 x 1.5 / M Ø 16 x 1.5 - Pz 5

232 010 67 M Ø 16 x 1.5 / M Ø 18 x 1.5 - Pz 5



232 01070 Maschio / Maschio per: Ford transit - Pz 5

NOTE

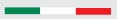

Blank area for notes with horizontal lines.

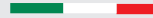

Made in Italy

www.afasupport.it



**Spina per estrazione flangia montante Ford
oda valigetta metallica**



Ford Transit



232 010 80 Piastra + 3 colonnette + 5 Perni + 5 Perni - Pz14

Utilizzabile solo in abbinamento con nostro Kit 232 010 50

Ricambi - Spare-parts

F14 x 2 M16 x 1.5

232 010 81 Pz 3

M16x2

232 010 82 Pz 5

Spina Ø8 M 10 x 1,5

232 010 83 Pz 5

Adattatori opzionali - Optional adaptor

Spina Ø9 M16 x 2

232 010 84 Pz 5

Utilizzo - Using

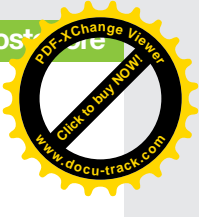
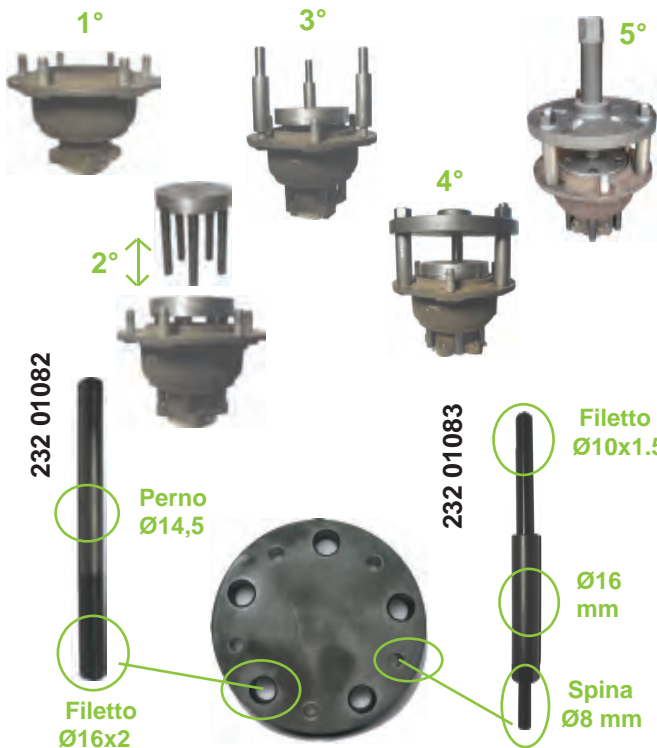

Estrattore smontaggio mozzo anteriore e post

Puller of front hubs



232 011 Citroen GS - ant. - 84x1,5

232 012 Citroen GS - Post. - 75x1.5

Estrattore smontaggio mozzo posteriore

Puller of front hubs



232 013 Citroen Diane-GS-Ami.

Estrattore smontaggio mozzo posteriore

Puller of front hubs



232 014 Citroen Diane-2Cv

Estrattore smontaggio mozzo posteriore

Puller of front hubs



232 016 Alfetta Giulia - Da usare 235 102

Chiave per ghiera regolazione cuscinetto mozzo posteriore vetture Fiat Idea & Lancia Musa

Tool bag on fiber



Att. 1/2"



Poligono



1/2"

232 018 Att. 1/2" - Poligonale mm 31

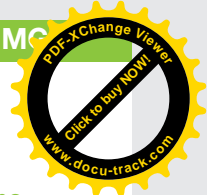
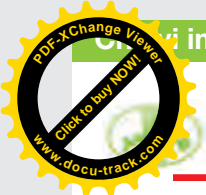

Chiave impact per ghiera mozzi



3/4"

Chiave impact per ghiera mozzo posteriore
vetture Fiat Idea & Lancia Musa

232 018 31 Att. 3/4" Poligonale mm 31

Chiave conica per ghiera mozzi anteriori

232 019 Att. 3/4" Poligonale mm 36

Chiave per ghiera mozzo posteriore

232 027 Att. 3/4" Poligonale mm 44

Chiave impact per mozzo Volkswagen

232 033 Att. 3/4" Poligonale mm 33

Chiave impact per mozzo Volkswagen

232 037 Att. 3/4" Poligonale mm 37

Chiave impact per mozzo Volkswagen

232 039P Att. 3/4" Poligonale mm 39

Chiave per mozzi Ducato

232 045P Att. 3/4" Poligonale mm 45

Chiave per mozzi Ducato (nuovi modelli)

232 055P Att. 3/4" Poligonale mm 55

Chiavi coniche impact per ghiera mozzi



3/4"

Chiave conica per ghiera mozzo anteriore

232 020 Att. 3/4" Esagono mm 36

Chiave conica per ghiera mozzo fiat Ducato

232 024 Att. 3/4" Esagono mm 41

Chiave conica per ghiera mozzo anteriore Daily

232 025 Att. 3/4" Esagono mm 42

Chiave conica per ghiera mozzo Ducato 2.4

232 028 Att. 3/4" Esagono mm 46

Estrattore per mozzi posteriori con ruote gemellate Iveco Daily



232 023 Vite 36 x 2 x 200 per ozzi da 8 e 9 fori

Chiave conica impact per ghiera mozzo Mercedes

Tool bag on fiber



3/4"

232 026 Att. 3/4" - Ottagono mm 50

Set 5 pz. chiavi per ghiera mozzi e differenziali

5 pcs. drive tooth socket



232 030 Att. 1/2"

Ricambi - Spare parts

232 030 01 Ghiera Mercedes Ø42x35 - 4 denti da 6mm

232 030 02 Ghiera Mercedes Ø42x35 - 4 denti da 8mm

232 030 03 Ghiera Mercedes Ø43x35 - 4 denti conici da 6mm

232 03004 Ghiera Mercedes Ø46x38 - 4 denti conici da 6mm

232 070 Ghiera Mercedes Ø55x50 - Perno Ø27 - 4 denti da 8mm

Chiave per ghiera mozzi "4 denti"

Drive 4 tooth socket



Att. 1/2"

| | Att. | Dente | A interno | B esterno |
|----------------|------|-------|-----------|-----------|
| 232 031 | 1/2" | mm 6 | mm 30 | mm 35 |

Chiave ghiera mozzo posteriore ruota singola

Wrench for rear hubs nut single wheel



232 035 Transit - 64 x 50 x 6

Chiave ghiera mozzo posteriore ruote gemellari

Wrench for rear hubs nut twin wheels



232 036 Transit - 67 x 57 x 6

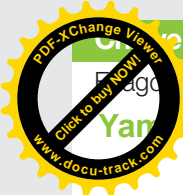

Chiave a bussola esagonale per mozzi Scooter

Wrench for scooter hubs



232 039 mm 39 - Att. 3/4"

Chiave ghiera mozzo anteriore

Wrench for front hubs nut

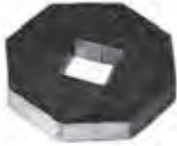

| | | |
|---------|-----------------------------|----------|
| 232 040 | 127 DAN-Fiorino-Uno Diesel | 48 mm |
| 232 041 | 127 1050-128- | 45-52 mm |
| 232 042 | 127 1050-128- | 52 mm |
| 232 043 | Alfa 33 u.t. | 65 mm |
| 232 044 | Alfa 33 u.t. economica | 65 mm |
| 232 045 | Alfa 33 -arna-164 | 68 mm |
| 232 046 | Alfa 33 -arna-164 economica | 68 mm |

Chiave ghiera mozzo anteriore

Wrench for front hubs nut



232 050 Nissan Vanette

Chiave ghiera mozzo anteriore

Wrench for front hubs nut



232 051 Alfa sud - 55 mm

Chiave ghiera mozzo anteriore e posteriore

Wrench for front and rear hubs nut



232 055 Lancia Beta - 65 x 58 x 8
 232 056 Lancia Gamma - 81 x 72 x 8

Chiave ghiera mozzo anteriore

Wrench for front hubs nut



232 059 Lancia Flavia-Fulvia u.t. - 50x40x8

Chiave ghiera mozzo anteriore

Wrench for front hubs nut



232 060 Lancia Flavia-Fulvia u.t. - 94 x 82 x 8

Chiave ghiera mozzo anteriore

Wrench for front hubs nut



232 063 Lancia Flavia-Fulvia - 53 x 44 x 6

Chiave ghiera esterna mozzo posteriore

Wrench for external rear hubs nut



232 065 62 x 53 x 12

Chiave a ghiera a 6 denti per Porter Piaggio

Wrench for Piaggio Porter

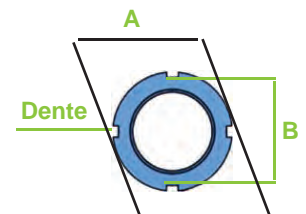

| | Att. | A-esterno | B-interno | Dente |
|------------|------|-----------|-----------|-------|
| 232 065 01 | 1/2" | mm 62 | mm 57 | mm 7 |

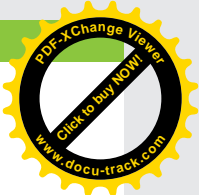

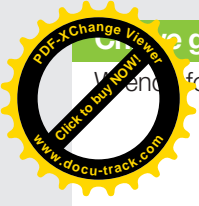

Chiave ghiera interna mozzo posteriore

Wrench for internal rear hubs nut



232 066 Lancia Flavia-Fulvia u.t. - 62 x 56 x 7

Chiave ghiera esterna mozzo posteriore

Wrench for external rear hubs nut



232 067 Lancia Flavia-Fulvia u.t. - 71 x 62 x 7

Chiave ghiera interna mozzo posteriore

Wrench for internal rear hubs nut



232 068 Lancia Flavia-Fulvia - 71 x 68 x 7

Chiave ghiera esterna mozzo posteriore

Wrench for external rear hubs nut



232 069 Lancia Flavia-Fulvia - 82 x 73 x 7

Chiave ghiera per mozzi posteriori Mercedes Benz mod. 107-114-115-116-126

Wrench for posterior hubs



232 070 Att. 1/2" - 4 Denti - Ø55x50x8 - Perno Ø 22

Chiave ghiera mozzo posteriore

Wrench for rear hubs nut



232 072 Alfa 75-164 - 70 x 61 x 7

Chiave ghiera mozzo posteriore

Wrench for external rear hubs nut



232 074 Alfetta - 66 x 59 x 7

Chiave ghiera mozzo posteriore

Wrench for external rear hubs nut



232 075 Regata-Duna weekend - 64 x 56 x 8

Chiave ghiera mozzo posteriore

Wrench for external rear hubs nut



232 078 Tipo - 18 mm

232 079 Tempra - 19 mm

Chiave ghiera mozzo posteriore

Wrench for external rear hubs nut



232 080 Polo-Golf - 1/2" - P 30 mm

Chiave dado mozzo posteriore

Wrench for rear hubs nut



232 082 Tipo - 32 mm

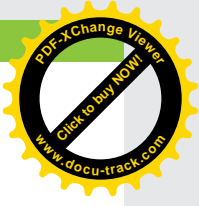

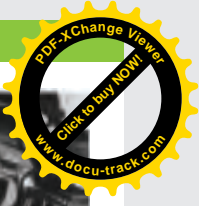
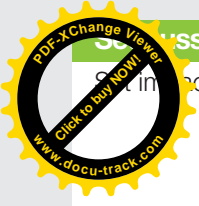

Bussola e maschi impact per ghiera e mozzi

Impact wrench for hubs nut



232 083 Pz 8 - Att. 1/2"

Composizione - Composition

- 414 529 30** Bussola poligonale lunga - mm 30 x 85 - Att 1/2"
- 414 529 32** Bussola poligonale lunga - mm 32 x 85 - Att. 1/2"
- 414 529 34** Bussola poligonale lunga - mm 34 x 85 - Att. 1/2"
- 414 529 35** Bussola poligonale lunga - mm 35 x 85 - Att. 1/2"
- 414 529 36** Bussola poligonale lunga - mm 36 x 85 - Att. 1/2" -
- Maschi esagonali Pz 3 - mm 14 - 17 - 19 - Att. 1/2"

Chiave ghiera semiassi

Wrench for internal axle



232 084 Simca 1100-1307-1308 - 67 x 61 x 8

Chiave ghiera mozzo posteriore

Wrench for and front hubs nut



232 086 Citroen GS - 83 x 70 x 7

Set pad pulizia incrostazioni da mozzi e cerchi

Wheel hub grinder

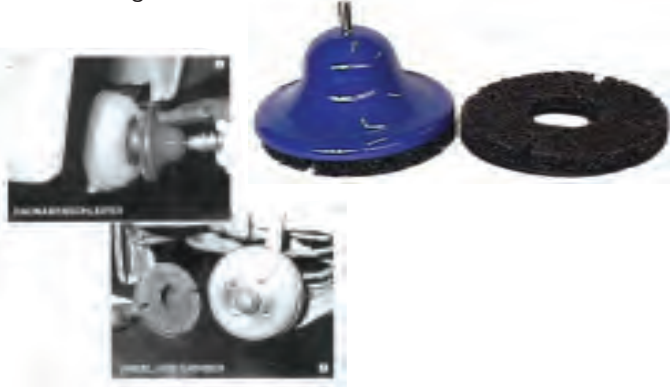

232 090 Campana Ø 150 + 3 Pad

Ricambi - Spare-parts

232 091 Pad singolo

Set pulizia base prigionieri su mozzi ruote

Wheel hub grinder

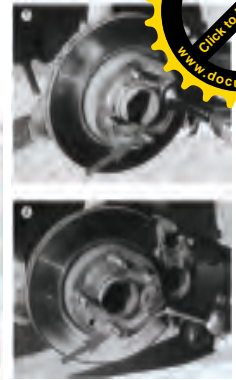

232 092 Campana Ø45 + 6 Pad / Campana Ø55 - 6 Pad

Ricambi - Spare-parts

232 093 Pad Ricambio Ø55

232 094 Pad Ricambio Ø45

Set pulizia base prigionieri su mozzi ruote

Wheel hub grinder

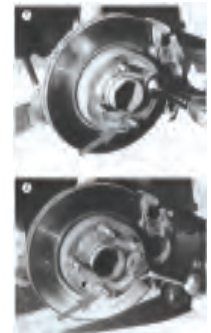

232 092 00

Composizione - Composition

- 1 Campana Ø 45 con 6 pad
- 1 Campana Ø 55 con 6 pad
- 1 Adattatore att. 1/2"

Ricambi - Spare-parts

232 093 Pad Ø55 (singolo)

232 094 Pad Ø45 (singolo)

Set pad di pulizia mozzi per furgoni RPM 1000max

Wheel hub grinder



232 096 1 Campana + 2 Pad Ø200

Ricambi - Spare-parts

232 097 Pad Ricambio - Ø200

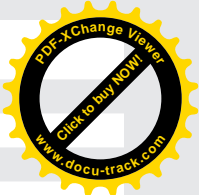
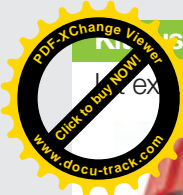

Bussole estrazione prigionieri ruote veicoli

Extraction imprisoned car wheels

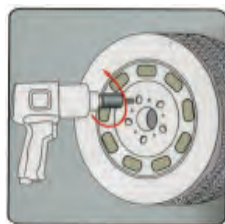

232 100 Valigetta completa - Pz. 6

Ricambi - Spare-parts

- 232 100 00 Bussola 10 mm
- 232 100 01 Bussola 12 mm
- 232 100 02 Bussola 14 mm
- 232 100 03 Bussola 17 mm
- 232 100 04 Bussola 19 mm
- 232 100 05 Bussola 21 mm.

Kit bussole con filetto passo sinistro per estrazione prigionieri rovinati ruote veicoli

Damaged nuts remover kit



232 101 Att 1/2" - Pz 7

Ricambi - Spare-parts

- 232 101 01 Bussola 1/2" - mm 17
- 232 101 02 Bussola 1/2" - mm 18,5
- 232 101 03 Bussola 1/2" - mm 20
- 232 101 04 Bussola 1/2" - mm 21,5
- 232 101 05 Bussola 1/2" - mm 23
- 232 101 06 Bussola 1/2" - mm 24,5
- 232 101 07 Bussola 1/2" - mm 26

Kit estrazione dadi rovinati

Damaged nuts remover kit



Dis. elicoidale



1/4"

1/2"

232 104 In valigetta Pz.15

Composizione - Composition

- Attacco 1/4" - mm 6, 8, 10, 11, 12
- Attacco 1/2" - mm 13, 14, 15, 17, 19, 21, 24, 27
- Asta Ø 6 lunga mm 70
- Asta Ø 12 lunga mm 80

Ricambi - Spare-parts

- 232 104 17 Bussola 1/2" mm 17
- 232 104 19 Bussola 1/2" mm 19
- 232 104 21 Bussola 1/2" mm 21
- 232 104 24 Bussola 1/2" mm 24
- 232 104 27 Bussola 1/2" mm 27

Set 9 pz. bussole svita dadi rovinati



232 105 mm 10-11-12-13-14-15-16-17-19 - Att 1/2"

Kit bussole lunghe con espulsore per dadi rovinati

Twist socket set

Acciaio Cr.
Molibdeno
Brunito



mm 150

232 106 Pz 3 - mm 17-19-21 - Att 1/2"

Set 7 Pz. distanziali per estrazione cuscinetti mozzi utilizzabili con pressa

Set 7 Pcs outdistance them for extraction usable cut-off pads with press



232 110 Valigetta completa - 7 pz.

Ricambi - Spare-parts

- 232 110 01 Dist. per cusc. Renault
- 232 110 02 Dist. per cusc. Peugeot 106
- 232 110 03 Dist. per cusc. Fiat-WV Golf-Opel Corsa/Astra
- 232 110 04 Dist. per cusc. Citroen
- 232 110 05 Dist. per cusc. Peugeot 205
- 232 110 06 Dist. per mozzo Fiat-WV-Opel-Peug-Alfa-Lancia
- 232 110 07 Dist. per mozzo Ford-Peugeot-Fuoristrada
- 232 110 08 Dist. per Mozzo. Renault Traffic
- 232 110 09 Dist. per cusc. Renault Traffic.

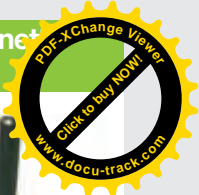

Pz. distanziali per estrazione cuscinetti mozzi moili con pressa

Set 3 es. outdistance them for extraction usable cut-off
pack with press



232 112 Valigetta completa

Ricambi - Spare-parts

232 112 01 Dist. per cusc. Renault Laguna

232 112 02 Dist. per cusc. Peugeot 206

232 112 03 Dist. per cusc. VW Golf IV-Audi A3

Set Perno con rondelle per estrazione ed inserimento cuscinetti mozzo

Kit for hubs nut



232 114

Kit estrazione mozzi guida Bmw

Puller for drive shafts

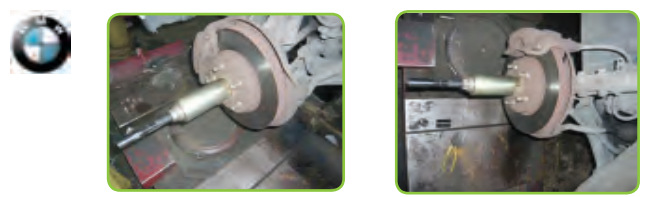

232 115

Composizione - Composition

- M 16 x 1,5 - per Subaru
- M 20 x 1,5 - per Vw Beetle - Touareg - Porsche Cayenne
- M 22 x 1,5 - per Bmw E 30 - E 46
- M 24 x 1,5 - per Bmw E36 - Mercedes W203
- M 27 x 1,5 - per Bmw E32 - E34 - E38 - E39 - X5
- M 30 x 1,5 - per Bmw E32 - E34 - E36

Attrezzo universale per estrazione dei cuscinetti mozzi con l'utilizzo della pressa



Brevetto depositato



Per vederne l'utilizzo tramite
filmato clicca:
WWW.AFASUPPORT.IT
CLICCA: AGGIUNTA 2007
CLICCA: 232 120

232 120 Attrezzo in Alluminio lucido (in valigetta)

232 120 20 Attrezzo in alluminio Anodizzato (in valigetta)

Ricambi - Spare-parts

232 120 01 Perno corto per piastra traslante

232 120 02 Coppia perni corti + rondelle + bulloni per prigionieri

232 120 03 Coppia perni medi + rondelle + bulloni per prigionieri

232 120 04 Bullone con rondella per blocco piastra traslante

Attrezzo universale per estrazione dei cuscinetti mozzi dei veicoli commerciali con l'utilizzo della pressa

Tool bag on fiber



Brevetto depositato

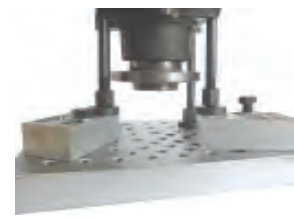

232 120 50 Attrezzo in Alluminio lucido (in valigetta)

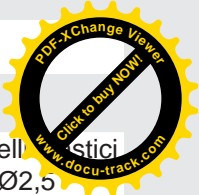
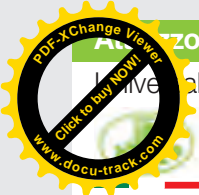

Mozzo estrazione piste cuscinetti

Universal tool for extraction ruller and ball bearing



Brevetto depositato

Per vederne l'utilizzo
tramite filmato clicca:
WWW.AFASUPPORT.IT
Clicca: Novità
Clicca: Simo 232 121

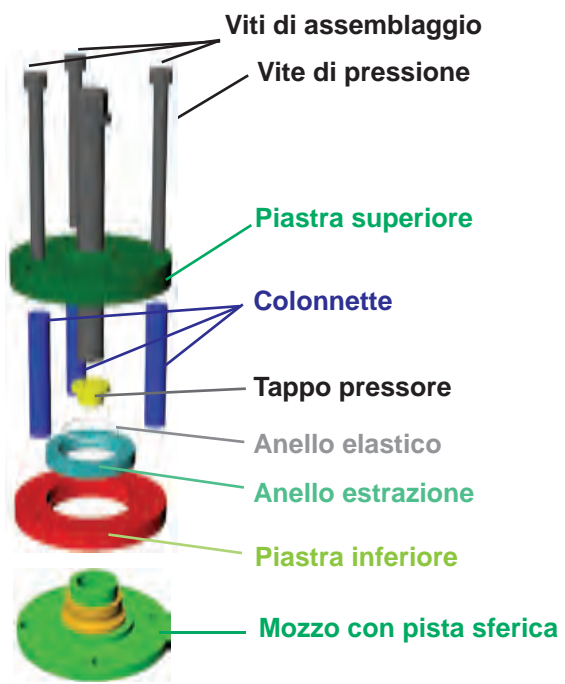

Attrezzo per estrarre in pochi minuti ed in sicurezza, tutte le piste dei cuscinetti:

- A sfere (con o senza cava di schermatura)
- A rulli conici

Grazie alla dotazione di 7 anelli di estrazione di diverso diametro, ognuno dotato di 3 anelli elastici di uguale diametro ma di spessori corda diversi: Ø1,5 - 2 - 2,5 - Simo oltre che di semplice utilizzo, si rende Universale

Risolve un problema annoso per interventi di sostituzione dei cuscinetti sui mozzi

232 121 Kit in comoda valigetta termosoffiata.
Attrezzo + 1 Tappo pressore + 9 anelli di estrazione + 24 anelli elastici

Anello estrattore

| | Ø Esterno | Ø Interno | Spessore |
|------------|-----------|-----------|---|
| 232 121 01 | mm 70 | mm 38 | mm 11 + N° 3 anelli elastici Ø1,5 / Ø2 / Ø2,5 |
| 232 121 02 | mm 70 | mm 42 | mm 11 + N° 3 anelli elastici Ø1,5 / Ø2 / Ø2,5 |
| 232 121 03 | mm 70 | mm 45 | mm 11 + N° 3 anelli elastici Ø1,5 / Ø2 / Ø2,5 |
| 232 121 04 | mm 70 | mm 47 | mm 11 + N° 3 anelli elastici Ø1,5 / Ø2 / Ø2,5 |
| 232 121 05 | mm 70 | mm 49 | mm 11 + N° 3 anelli elastici Ø1,5 / Ø2 / Ø2,5 |
| 232 121 06 | mm 70 | mm 52 | mm 11 + N° 3 anelli elastici Ø1,5 / Ø2 / Ø2,5 |
| 232 121 07 | mm 70 | mm 54 | mm 11 + N° 3 anelli elastici Ø1,5 / Ø2 / Ø2,5 |
| 232 121 08 | mm 70 | mm 57 | mm 11 + N° 3 anelli elastici Ø1,5 / Ø2 / Ø2,5 |
| 232 121 10 | | | Per mozzo Vw Golf IV serie con ruota fonica + N° 3 anelli elastici Ø1,5 / Ø2 / Ø2,5 |

Cuffia riparo per montanti ruota

Per lavorare senza sporcarsi e senza respirare polveri tossiche



232 125

Attrezzo universale per estrazione giunti omocinetic dai semiassi



232 130 In Valigetta

Attrezzo divaricatore per testine sterzo e supporti ammortizzatori, dotato di due cunei separatori intercambiabili

Universal steering knuckle spreader tool

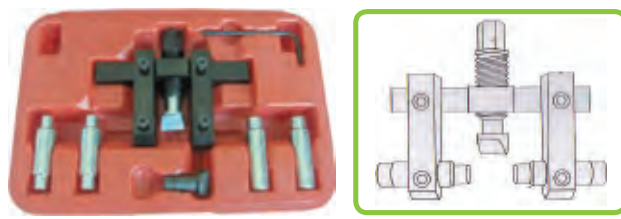

232 135

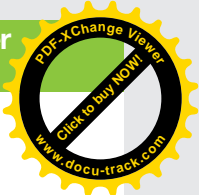
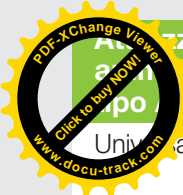

**Setto divaricatore per supporti
artizzatori e giunti sferici singoli o doppi
di Audi e Volkswagen**

Universal steering knuckle spreader tool



Utilizzo con doppio perno



Utilizzo con singolo perno

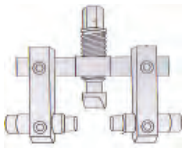

232 136 In valigetta

Chiave dado fissaggio ruota a croce

Wrench for weels nuts



233 011 17-19-21-22 mm

233 012 17-19-22 mm 1/2"

Chiave a croce per ruote autocarri leggeri

Cross key for wheels trucks



233 015 24 x 27x 30 x 3/4

Set chiavi plastificate per bulloni cerchi in lega

Key set plasticized for bolts rims in league



233 019 17-19-21-13/16

**Set 3pz. chiavi con protezione in plastica per
cerchioni ruote in lega**

Plastified wrenches for weels nuts



233 020 17 - 19 - 21

233 021 17 - 19 - 22

Chiave plastificata per cerchi in lega

Key plasticized for you look for in league

233 022 mm 17

233 023 mm 19

233 024 mm 21

233 025 mm 22

233 026 mm 23

233 027 mm 14

233 029 13/16"



**Set 3 bussole lunghe per bulloni ruote in lega dei
fuoristrda**

Tool bag on fiber



233 030 l mm 150 mm 17 - 19 - 21

Set 3 pezzi chiavi dinamometriche a bussola

Set 3 Pcs dinamometric wrench

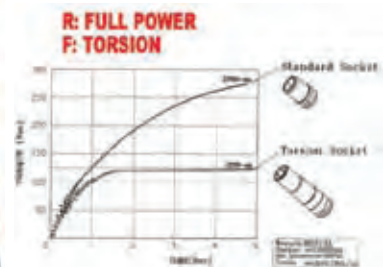

233 032 serraggio max 10 Kgm - mm 17-19-21

Da utilizzare con avvitatore, per il serraggio rapido dei dadi ruote senza correre il rischio di uno strappo finale. E' consigliabile un controllo finale con chiave dinamometrica

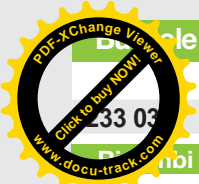

Chiave dinamometriche

233 03

Set 5 pz.

U.S.A.

Chiavi - Spare-parts

- 233 036 Kgm 11 mm 17
- 233 037 Kgm 9 mm 19
- 233 038 Kgm 11 mm 19
- 233 039 Kgm 11 mm 21
- 233 040 Kgm 7,5 mm 19



Set chiavi dinamometriche dado fissaggio ruota con quadro maschio 1/2" per bussole a macchina

Dinamometric wrenches for weels nuts



233 050 9-10-11-12-13.5-15-16-17.5-19-20 Kg.m - 1/2"

Chiave dinamometrica dado fissaggio ruota con quadro maschio da 1/2"

Dinamometric wrench for weels nuts

1/2"



| | Colore | Kg.m |
|---------|---------|------|
| 233 051 | Verde | 9.0 |
| 233 052 | Nero | 10 |
| 233 053 | Giallo | 11 |
| 233 054 | Rosso | 12 |
| 233 055 | Blu | 13 |
| 233 056 | Arancio | 15 |

Chiave dinamometrica impact per Truck

Impact dynamometric wrench for truck



Acciaio Cr. Molibdeno -
Brunito

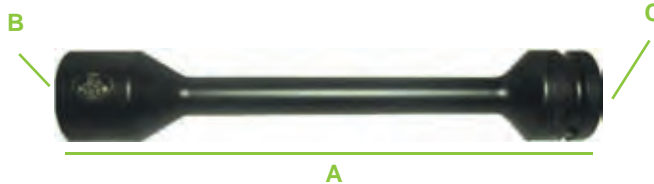

| | A | B | C |
|---------|----------------|--------|--------|
| 233 070 | mm 305 x mm 27 | Att.1" | Kgm 45 |
| 233 071 | mm 305 x mm 30 | Att.1" | Kgm 55 |
| 233 072 | mm 305 x mm 32 | Att.1" | Kgm 60 |
| 233 073 | mm 305 x mm 33 | Att.1" | Kgm 65 |
| 233 074 | mm 305 x mm 34 | Att.1" | Kgm 65 |
| 233 075 | mm 315 x mm 36 | Att.1" | Kgm 65 |

Pinza per contrappesi cerchi ruota auto

Wheel weight balance plier



233 090

Pinza per piombi ruote con molla

Wheel weight balance plier



mm 230



233 092

Attrezzo per la posa e la rimozione dei pesi a molla separata

Clip fitting tool



233 094 Apertura: 15,5mm e 19mm

Attrezzo speciale per la posa sicura e veloce dei pesi a molla separata

The compression tool



233 095 Apertura max: 335mm

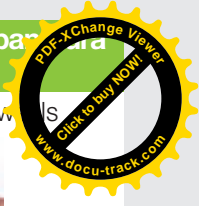
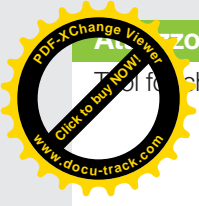

Attrezzo misurazione inclinazione ruote ant. auto

Tool for checking wheel inclination



233 100 Universale - mm 500

233 101 Fuoristrada SUV - mm 800

Attrezzo misurazione convergenza ruote ant.

Tool for checking wheel convergens



233 102 Universale

Livella magnetica rilevazione angolo campanatura; range $\pm 5^\circ$ con incrementi di 0.5°



233 110

Livella magnetica con testa snodata rilevazione angolo campanatura; range $\pm 5^\circ$ con incrementi di 0.5°



233 111

Set 2 pz livella fissa e snodata rilevazione angolo campanatura; range $\pm 5^\circ$ con incrementi di 0.5°



233 112

Divaricatore per regolazione angolo di campanatura con due corpi esagonali

Double tool for registration of incidence of front wheels



233 210 VW Golf Polo

Contrappesi in Zinco plasticati per equilibratura ruote vetture

Zinco



| | | | |
|---------|----------|---------|--------|
| 233 300 | Standard | pz. 100 | gr. 05 |
| 233 301 | Standard | pz. 100 | gr. 10 |
| 233 302 | Standard | pz. 100 | gr. 15 |
| 233 303 | Standard | pz. 100 | gr. 20 |
| 233 304 | Standard | pz. 100 | gr. 25 |
| 233 305 | Standard | pz. 100 | gr. 30 |
| 233 306 | Standard | pz. 50 | gr. 35 |
| 233 307 | Standard | pz. 50 | gr. 40 |
| 233 308 | Standard | pz. 50 | gr. 45 |
| 233 309 | Standard | pz. 50 | gr. 50 |

Contrappesi in Zinco plasticati per equilibratura ruote vetture

Zinco



| | | | |
|---------|----------------|---------|--------|
| 233 320 | Cerchi in lega | pz. 100 | gr. 05 |
| 233 321 | Cerchi in lega | pz. 100 | gr. 10 |
| 233 322 | Cerchi in lega | pz. 100 | gr. 15 |
| 233 323 | Cerchi in lega | pz. 100 | gr. 20 |
| 233 324 | Cerchi in lega | pz. 100 | gr. 25 |
| 233 325 | Cerchi in lega | pz. 100 | gr. 30 |
| 233 326 | Cerchi in lega | pz. 50 | gr. 35 |
| 233 327 | Cerchi in lega | pz. 50 | gr. 40 |
| 233 328 | Cerchi in lega | pz. 50 | gr. 45 |
| 233 329 | Cerchi in lega | pz. 50 | gr. 50 |

NOTE

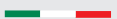

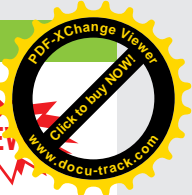
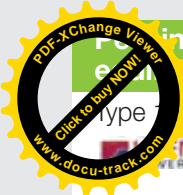

Pesi in Zinco modello "HOFMANN Type 161" per equilibratura cerchi in ferro

Type 161 with integral clip



| | | |
|---------|--------|---------|
| 233 350 | Gr. 5 | 100 pz. |
| 233 351 | Gr. 10 | 100 pz. |
| 233 352 | Gr. 15 | 100 pz. |
| 233 353 | Gr. 20 | 100 pz. |
| 233 354 | Gr. 25 | 100 pz. |
| 233 355 | Gr. 30 | 100 pz. |
| 233 356 | Gr. 35 | 50 pz. |
| 233 357 | Gr. 40 | 50 pz. |
| 233 358 | Gr. 45 | 50 pz. |
| 233 359 | Gr. 50 | 50 pz. |
| 233 360 | Gr. 55 | 50 pz. |
| 233 361 | Gr. 60 | 50 pz. |

Pesi in Zinco modello "HOFMANN Type 666" per equilibratura cerchi in lega

Type 666 with integral clip



| | | |
|---------|--------|---------|
| 233 370 | Gr. 5 | 100 pz. |
| 233 371 | Gr. 10 | 100 pz. |
| 233 372 | Gr. 15 | 100 pz. |
| 233 373 | Gr. 20 | 100 pz. |
| 233 374 | Gr. 25 | 100 pz. |
| 233 375 | Gr. 30 | 100 pz. |
| 233 376 | Gr. 35 | 50 pz. |
| 233 377 | Gr. 40 | 50 pz. |
| 233 378 | Gr. 45 | 50 pz. |
| 233 379 | Gr. 50 | 50 pz. |
| 233 380 | Gr. 55 | 50 pz. |
| 233 381 | Gr. 60 | 50 pz. |

Contrappesi adesivi tipo "Slim" in Ferro

Ferro

12x5



4x5 - 4x10



| | | | |
|------------|----------------|--------|--------|
| 233 396 | 12 x 5 | Gr. 60 | Pz 100 |
| 233 396 01 | 4 x 5 - 4 x 10 | Gr. 60 | Pz 100 |

Rotolo contrappesi in ferro per auto



233 398 1.000 segmenti da 5 gr. - (5 kg)

Dati tecnici - Informative

Applicazioni su tutti i cerchi in lega leggera
Facile da staccare e da applicare
Larghezza: 19mm x Altezza: 3,5mm (incl.nastro adesivo)

Adattatori opzionali - Optional adaptor



233 399 Porta-rotolo (Venduto vuoto)

Multifunzionale per il montaggio al banco oppure alla parete.
Pratico metro sul lato esterno con dispositivo di taglio integrato per poter operare in modo rapido e pratico

"Speedliner Hofmann" Contrappesi slim

Type 380 Zinc adhesive weight for cars

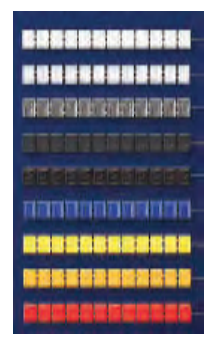

1 striscia = 12pesi da 5gr.



| | | |
|---------|-----------|------------|
| 233 400 | Grigio | 25 strisce |
| 233 401 | Nero | 25 strisce |
| 233 402 | Cromato | 25 strisce |
| 233 403 | Antracite | 6 strisce |
| 233 404 | Bianco | 6 strisce |
| 233 405 | Blu | 6 strisce |
| 233 406 | Giallo | 6 strisce |
| 233 407 | Arancio | 6 strisce |
| 233 408 | Rosso | 6 strisce |

Dati tecnici - Informative

H3,8mm x 19mm
Innovativo nastro adesivo brevettato, oltre che essere più forte e veloce da applicare è comodissimo da rimuovere poichè non lascia traccia / residui del suo passaggio.
Inoltre le barrette sono legate tra di loro per seguire meglio la curvatura di qualsiasi cerchio
Forte resistenza alla corrosione

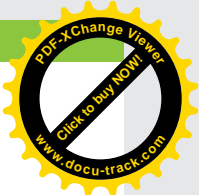
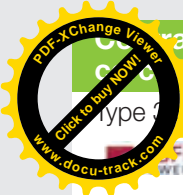

Appesi adesivi "Hofmann" in zinco per in lega

Zinc adhesive weight for cars



| | | |
|---------|--------|---------|
| 233 410 | Gr. 5 | 100 pz. |
| 233 411 | Gr. 10 | 100 pz. |
| 233 412 | Gr. 15 | 100 pz. |
| 233 413 | Gr. 20 | 100 pz. |
| 233 414 | Gr. 25 | 100 pz. |
| 233 415 | Gr. 30 | 100 pz. |
| 233 416 | Gr. 35 | 50 pz. |
| 233 417 | Gr. 40 | 50 pz. |
| 233 418 | Gr. 45 | 50 pz. |
| 233 419 | Gr. 50 | 50 pz. |
| 233 420 | Gr. 55 | 50 pz. |
| 233 421 | Gr. 60 | 50 pz. |

Tutte le altre tipologie di pesi "Hofmann" sono disponibili solo a richiesta



Valvole tubless SHRADER

Tubless valve

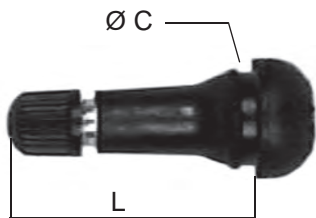

| | TR | L | C | pz. |
|---------|--------|----|----|-----|
| 233 601 | TR412 | 33 | 15 | 100 |
| 233 602 | TR413 | 35 | 15 | 100 |
| 233 603 | TR414 | 41 | 15 | 100 |
| 233 605 | TR414L | 48 | 15 | 100 |
| 233 607 | TR418 | 54 | 15 | 100 |

Valvole tubless snap-in ad alta pressione, indicata per mezzi furgonati: IvecoDaily - Fiat Ducato

High pressure tubeless snap-in valve

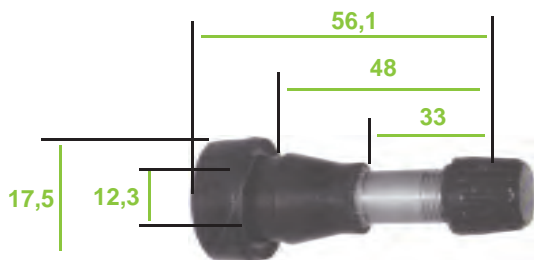

233 609 TR 600 - Pz 50

Pressione massima di gonfiaggio a freddo 5,5 BAR

Tappo valvole

Valve plug



233 610 In plastica - Pz 100

233 611 In metallo - Pz 100

Introduttore valvole con percussore

Percussion valve introducer



233 620

mm 280

Valvola interna per valvole pneumatici

Inside valve for valves pneumatic



233 630 Valvola corta . Pz. 100

Pezze riparazioni camere d'aria SHRADER

Tube repair patches SHRADER

| | | |
|---------|-------|--------|
| 233 811 | Ø 30 | Pz 100 |
| 233 812 | Ø 37 | Pz 30 |
| 233 813 | Ø 45 | Pz 30 |
| 233 814 | Ø 54 | Pz 30 |
| 233 815 | Ø 75 | Pz 30 |
| 233 817 | Ø 116 | Pz 30 |



Pezze riparazioni camere d'aria SHRADER

Tube repair patches SHRADER

233 825 Ø35 Pz 100

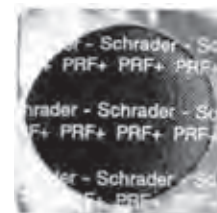

Pezze riparazioni camere d'aria SHRADER

Tube repair patches SHRADER



| | | |
|---------|---------|-------|
| 233 835 | 45 x 45 | Pz 50 |
| 233 836 | 60 x 60 | Pz 50 |

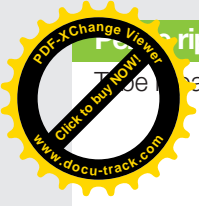

riparazioni camere d'aria SHRADER

air patches SHRADER



| | | |
|---------|---------|-------|
| 233 841 | 55x75 | 20 Pz |
| 233 842 | 70x115 | 10 Pz |
| 233 843 | 85x130 | 10 Pz |
| 233 844 | 90x75 | 20 Pz |
| 233 845 | 115x125 | 10 Pz |
| 233 846 | 100x195 | 10 Pz |

Fungo riparazione tubless SHRADER

Tools tubless repair



| | | |
|---------|----------|-------|
| 233 866 | Stelo Ø3 | 40 Pz |
| 233 867 | Stelo Ø6 | 24 Pz |

Stringhe riparazione pneumatici

Laces reparation pneumatic

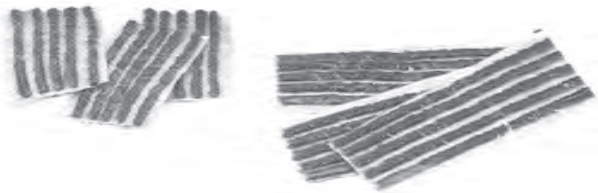

| | |
|---------|--------------------------------|
| 233 880 | Stringa per vettura - Pz. 30 |
| 233 881 | Stringa per autocarro - Pz. 30 |

Attrezzo riparazione pneumatici

Kit reparation pneumatic

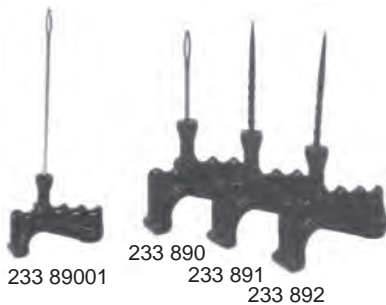

| | |
|------------|----------------------------------|
| 233 890 | Attrezzo ad ago universale |
| 233 890 01 | Attrezzo ad ago universale lungo |
| 233 891 | Attrezzo soluzionato. |
| 233 892 | Raspetta per vettura e Truck |

Set riparazione pneumatici

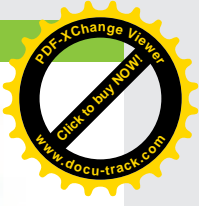

| | |
|---------|-------------|
| 233 893 | Per vettura |
| 233 894 | Per Truck |

Ricambi - Spare parts

| | |
|-----------|-------------------------------|
| 233 880 | Stringhe per vetture |
| 233 881 | Stringhe per truck |
| 233 890 | Attrezzo ad ago |
| 233 892 | Raspetta |
| 233 89301 | Valigetta vuota |
| 233 895 | Soluzione vulcanizzante 200cc |

Soluzione autovulcanizzante per riparazione pneumatici

Solution autovulcanizer for reparation pneumatic



| | |
|---------|--------|
| 233 895 | 200 cc |
|---------|--------|

Soluzione autovulcanizzante SCHRADER con pennello per riparazione pneumatici

Solution autovulcanizer SCHRADER for reparation pneumatic



| | |
|---------|---|
| 233 896 | Per camere d'aria - 250 cc - con pennello |
| 233 897 | Per pneumatici - 250 cc - con pennello |
| 233 899 | Pennello |

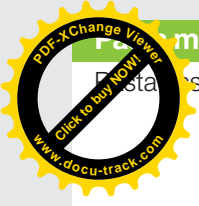

Montaggio pneumatici

Pasta pneumatici



- 233 898 Pasta per vetture - Kg 4
- 233 898 01 Pasta per autocarri - Kg 4

Rigatore elettrico per pneumatici

Electric cutter for pneumatic



- 233 900 SENZA LAME - 220 V

Lame ricambio per rigatore elettrico

Square blades for electric cutter



- 233 901 01 Lame - R1-3 20 Pz
- 233 901 02 Lame - R2-5 20 Pz
- 233 901 03 Lame - R3-6 20 Pz
- 233 901 04 Lame/ - R4-8 20 Pz
- 233 901 05 Lame - R5-10 20 Pz
- 233 902 01 Lame - W1-3 20 Pz
- 233 902 02 Lame - W2-5 20 Pz
- 233 902 03 Lame - W3-7 20 Pz
- 233 902 04 Lame - W4-9 20 Pz
- 233 902 05 Lame - W5-11 20 Pz

Misuratore battistrada°

Tread gauge



- 233 910

Calibro per il controllo del battistrada pneumatico

Acciaio Inox



- | | Range mm | Base mm | |
|---------|----------|---------|-----------|
| 233 911 | 0 - 50 | 70 | In fodera |

Smonta ammortizzatori pneumatico universale potenziato per tutti gli ammortizzatori di tipo McPerson conici ed inclinati

Universal pneumatic device for assembly and disassembly all type McPerson shock absorbers



- 234 000

Dati Tecnici:
 Press.Esercizio Atm. Min. 6 Max 10
 Spinta Max Kg. 735 (Atm 6) Kg. 980 (Atm 8)
 Ingombro: 140x65x40 cm Kg. 72
 Adatta per ammortizzatori decentrati e conici con trave autolivellante - Pratico cassetto porta attrezzi.
 Dotazione: artt.234 00001 - 00002
 Optionals: artt.234 00003 - 00005 - 00006 - 00007

Staffe per smonta ammortizzatori 234 000

Brachet for device 234 000



- 234 000 01 Inclusa nell'art. 234 000 - Per molle Ø 78 - 130 mm
- 234 000 02 Inclusa nell'art. 234 000 - Per molle Ø 125 - 205 mm
- 234 000 03 Per molle Ø 105 -182 mm



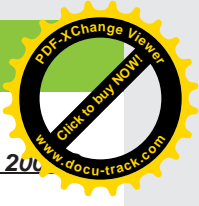
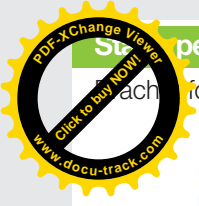

Staffe per smonta ammortizzatori 234 000

Brachet for device 234 000



- 234 000 05 Staffa superiore per Mercedes Classe A e C
- 234 000 06 Staffa superiore per Mercedes Classe E
- 234 000 07 Kit staffe per Mercedes Classe A-C-E

Staffe per smonta ammortizzatori 234 000

Brachet for device 234 000



- 234 000 08 Staffa superiore per Porsche Cayenne e Tuareg

Morsa bloccaggio ammortizzatori per art. 234 000

Blocking vice for shock absorbers



- 234 000 09 Opzionale

Smonta-ammortizzatori pneumatico a muro per tutti i tipi di ammortizzatori Mc Pearson

Wall Machine for disarm and reassemble all Mc Pearson system

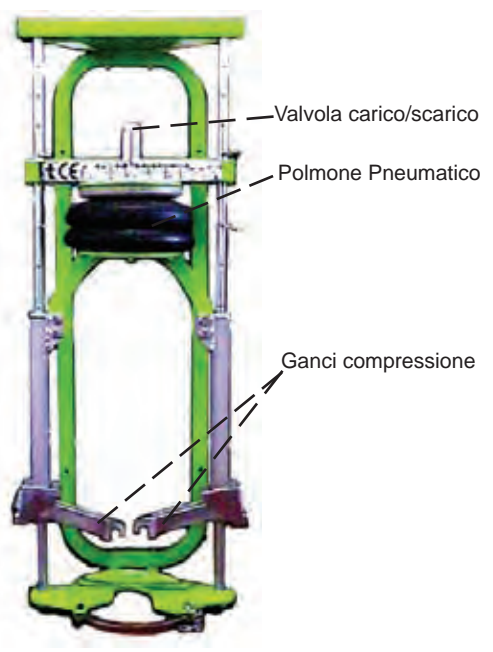

- 234 009 Normal Press. 1,5 - 2,5 Bar - Max - Press. 04 Bar - Corsa Soffietto 200 mm

Attrezzo pneumatico Brevettato per molloni ammortizzatori

Pneumatic tools "Patented" for soft dampers

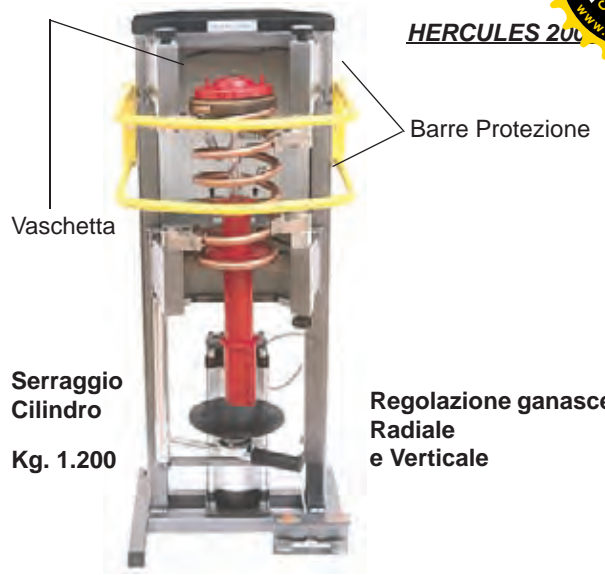

- 234 016 Dim. 46x45x115

Compressore per molle sospensione, perno a vite, spalla quadra, telescopico

Coil spring compressor



- 234 017 Mercedes

Attrezzo compressione molle sospensione anteriore

Front coil spring compressor



- 234 024 Renault Master

Attrezzo compressione molle sospensione anteriore

Front coil spring compressor



- 234 028 Giulia



Compressione coni in gomma sospensione

Tool for rubber bush suspensions



234 031 Mini-innocenti - 1/2" 20 fil - 14x2

Attrezzo con ganasce variabili per compressione molle ammortizzatori Mc-Pherson

Spring compressor Mc-Pherson



mm 470

234 033

Attrezzo con 3 coppie intercambiabili di ganasce per compressione molle ammortizzatori

Interchangeable fork spring compressor and removal tool



Range 80 - 115



mm 125

Range 110 - 150

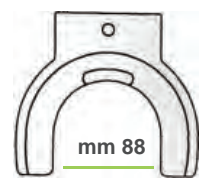

mm 160

Range 140 - 195



mm 212

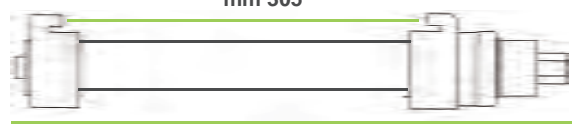

mm 453

234 035

234 035 01 Vite di ricambio

Compressore molle sospensioni

Coil spring compressor



234 040 Universale

Compressore molle sospensioni con doppio filetto destro e sinistro ed esagono centrale di manovra

Coil spring compressor



234 048 Universale - Apertura - 230 mm

Coppia compressori molle sospensioni con filetto destro/sinistro a sezione quadra e ganasce forgiate

Coil spring compressor



234 049 Max 800 Kgm - Viti mm 320

Coppia compressori molle per auto e furgoni, filetto a sezione quadra - ganasce in acciaio forgiato



234 050 Standard - Viti da mm 330

234 050 01 Coppia Viti Ricambio - Su richiesta - mm 260

234 050 02 Coppia Viti Ricambio - mm 320

Coppia compressori molle sospensioni con filetto destro/sinistro



234 052 Max 800 Kgm - Viti mm 270/320

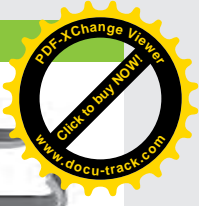

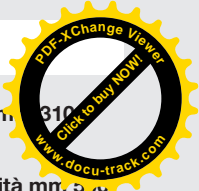

**Pressa bicilindrica smontamolle ammortizzatori
a corsa orientabile per tutti gli ammortizzatori
Mec Pherson**



234 060

Pressione di esercizio - Min. 6 bar Max 12 bar
Capacità di spinta - 6 bar Kg 800 - 8 bar Kg 1120
10 bar Kg 1400 - 12 bar Kg 1680
Diametro molle - Min. mm 80 Max mm 230
Dimensioni - mm 600x580x1240
Peso - Kg. 68

Pressa smonta ammortizzatori pneumatica

Pneumatic tools



Leva sblocco protezione

Schermo di protezione

Viti regolazione altezza
ganci superiore



234 065

Pedaliera azionamento
pressa

Presi molle su
tre punti

volantino di regolazione
larghezza ganci

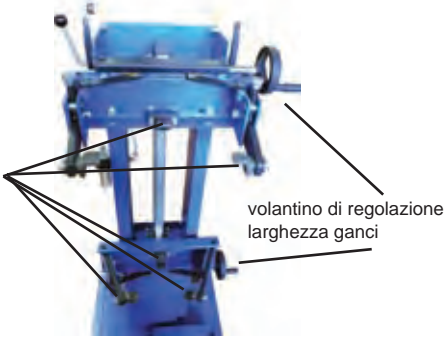

Dati tecnici - Informative

Dati tecnici:
Min diametro molla: mm 80 - Max diametro molla: mm 230
Corsa: mm 440
Diametro pistone di spinta: mm145
Misure: Altezza mm1400 - Larghezza mm580 - Profondità mm. 580
Peso: Kg 68
Pressa dotata di uno schermo protettivo antifortunistico collegato ad un limitatore di pressione che a schermo alzato limita la pressione a 1.5 bar dando la possibilità all'operatore di posizionare la molla in sicurezza

**Smonta-ammortizzatori manuale per molloni
Mec Pherson**

Manual tools Mac pherson Mechanism



Supporto
optional

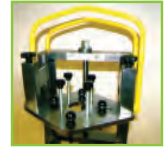

Piastra
optional



Base optional



Sono predisposti 4 fori per il
posizionamento a terra, consigliabile
anche se non necessario

234 070

Adattatori opzionali - Optional adaptor



234 070 10 Piastra universale per ammortizzatori sportivi
utilizzabile con i modelli: 234 016 "Hercules" - 234 070



234 070 11 Supporto regolabile



234 07012 Base supplementare mm 300

Dati tecnici - Informative

- Capacità di compressione: 1800 Kg
- Larghezza: 45 Cm
- Profondità: 40 Cm
- Altezza: 118 Cm
- Peso: 47 Kg

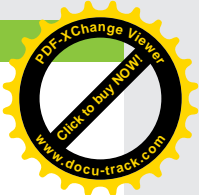
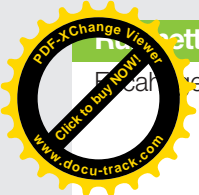

Chiave di carica

Charging tap



234 100 Innocenti-Rover

Chiave dado ritegno bracci oscillanti

Wrench for rear hubs ring nut



234 120 242 Diesel

Set di chiavi smontaggio dado ammortizzatori a bussola foro passante e cricchetto a frizione continua

Set of shock absorber wrenches with ratket



234 130 17-19-21-22-24 mm

Bussole ricambio / Sockets

234 131 17 mm

234 132 19 mm

234 133 21 mm

234 134 22 mm

234 135 24 mm

Chiave ghiera ritegno ammortizzatore

Spanner for hold shock absorber stem



234 145 Golf-Audi - 25 x 15 x 4

234 146 Polo - 25 x 12 x 4

234 147 Passat - 25 x 15 x 5

234 148 Rover - 25 x 12 x 3,5

Chiave smontaggio dado ammortizzatori

Wrench for shock absorber



234 150 Tipo-Punto - 18 mm

234 151 Passat-Audi 100-Marea - 19 mm

234 152 Golf - 21 mm

234 153 Audi 80-100-Kappa - 22 mm

Chiave smontaggio dado ammortizzatori

Wrench for shock absorber



234 165 Tipo-Punto - 18 mm

234 166 Passat-Audi 100-Marea - 19 mm

234 168 Audi 80-100-Kappa - 22 mm

Chiave supporto motore lato distribuzione Citroen

Key timing side engine mount Citroen



234 160

Chiave ritegno stelo ammortizzatori

Wrench for retaining shock absorber



234 170 Ritmo-Regata

Chiave smontaggio dado ammortizzatori

Wrench for shock absorber



234 171 Fiat 126-Nuova 500 - Int femmina 6 mm - 17 mm

234 172 Fiat Uno - Int femmina 7 mm - 19 mm

234 173 Peugeot-Renault R14 - Int a lama 10 mm - 21 mm

234 174 Alfa 164 - Int brugola 7 mm - 22 mm

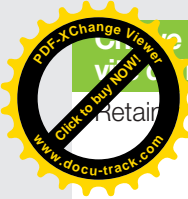

234 178 Anello fissaggio ammortizzatori per manovra

Wrench for shock absorber



234 178 Tipo-Punto

234 179 Alfa 155-Tempra-Dedra-Brava

Chiave ghiera fissaggio ammortizzatori

Wrench for locking nut shock absorber



234 181 Golf-Polo

234 182 Audi 80-90-100 - 24 mm

Attrezzo rotazione barra di torsione

Tool for rotating twisting axle

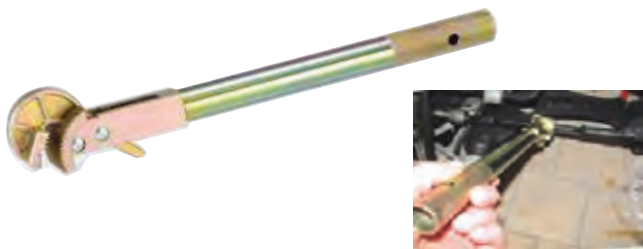

234 201 Universale Ø 14-23

234 201 40 Universale Ø 40-45

Estrattore Silent block per Vw polo



234 202 Completo

Ricambi - Spare-parts



234 202 10 Anello Ø 61 x 10



234 202 11 Anello Ø 73,8 x 10



234 202 12 Anello Ø 79 x 42



234 202 13 Barra filettata con dadi e rondelle



234 203 01 Anello Ø 85 x 74

Estrattore silent block per ponti Fiat Punto

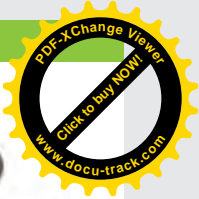

234 203 Completo

Ricambi - Spare-parts

234 203 01 Anello Ø 85 / 74 mm

234 203 02 Anello Ø 77 / 67 mm

234 203 03 Anello Ø 59 / 44 mm

234 203 04 Anello Ø 73 Sagomato

234 203 05 Anello Ø 62 / 55 mm Alto

234 203 06 Anello Ø 62 / 55 mm Basso

234 203 07 Ranella di pressione

234 203 08 Barra filettata con dadi e ranelle

NOTE

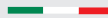

Blank area for notes



www.afasupport.it

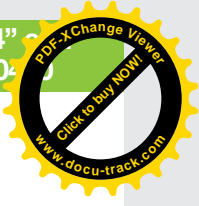
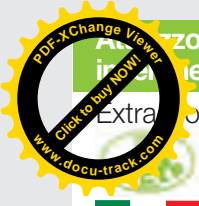

Attrezzo con pistone idraulico per estrazione ed aumento boccole Silentblock su ponti posteriori

Extraction / Introducer tool silentblock

Per vederne l'utilizzo tramite filmato clicca:
WWW.AFASUPPORT.IT
 CLICCA: 234 204 silent blc

“Per Fiat STILO e Nuova BRAVO”



- 234 204** solo attrezzo con 2 pressori e 1 guida
- 234 204 01** Attrezzo con 2 pressori e 1 guida + Pompa idraulica manuale
- 234 204 02** Attrezzo con 2 pressori e 1 guida + Pompa idraulica pneumatica

Ricambi - Spare-parts

-  **234 204 03** Pistone idraulico
-  **234 204 04** Coppia di tiranti
-  **234 204 05** Pressore con 3 perni per inserimento
-  **234 204 06** Pressore a tazza per estrazione
-  **234 204 07** Piastra filettata superiore
-  **234 204 08** Piastra di contrasto inferiore
-  **234 204 09** Pompa idraulica manuale - 450 bar - 17 Ton
-  **234 204 10** Pompa idraulica pneumatica - 700 bar - 20 Ton
-  **234 204 40** guida introduttrice

Valvola a innesto rapido con maschio da 1/4" ritenuta per pompe idrauliche 234 20409 / 20410



234 204 11

Riduzioni / Aumentatori da applicare ai pistoni dei pistoni crick da fossa utilizzabili con nostri articoli: 234 204 35 e 520 610 10



| Riduzioni | A | B |
|-------------------|----------|----------------|
| 234 204 22 | ØEst. 35 | x pistoni Ø 22 |
| 234 204 25 | ØEst. 35 | x pistoni Ø 25 |
| 234 204 30 | ØEst. 35 | x pistoni Ø 30 |



| Aumentatori | A | B |
|-------------------|----------|----------------|
| 234 204 40 | ØInt. 45 | x pistoni Ø 40 |
| 234 204 45 | ØInt. 45 | x pistoni Ø 45 |



Adattatore orientabile con blocco perno a sfera per nostro 234 204 (estrattore silent block)



| | C | D |
|-------------------|------|------|
| 234 204 35 | Ø 35 | Ø 45 |

L'adattatore monta di serie un innesto per il pistone del crick di Ø35, mentre i per pistoni di Ø22, Ø25, Ø30, Ø40, Ø 45 come optional - a richiesta sono disponibili 5 adattatori



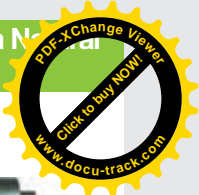
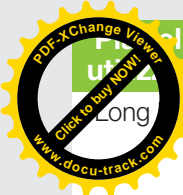

**Plattone in ferro con tampone "Long life" e
pila su crick da fossa con pistone Ø 35**

Long life rubber block for crick



| | C | D |
|------------|------|------|
| 520 610 10 | Ø 35 | Ø 45 |

Il piattello monta di serie un innesto per il pistone del crick di Ø35, mentre i per pistoni di Ø22, Ø25, Ø30, Ø40, Ø 45 come optional a richiesta sono disponibili 5 adattatori



Estrattore economico a vite per silent block ponte posteriore Fiat Stilo e nuova Bravo

Extraction silent block Fiat Stilo & Bravo new

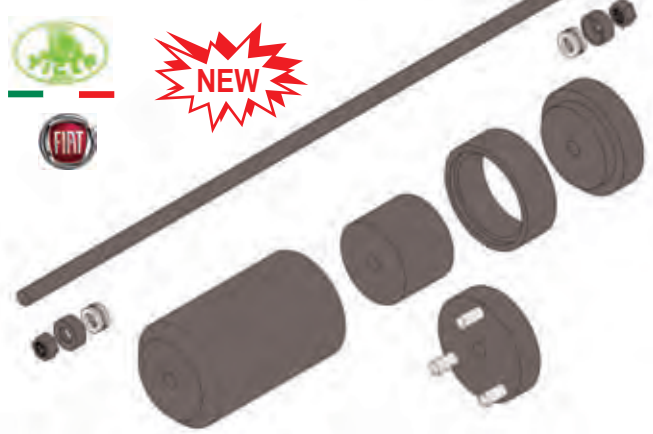

234 204 50 New kit completo

Ricambi - Spare-parts

- 234 204 51 Anello tubo a ø85x68x140
- 234 204 52 Anello tubo b ø85x67x30
- 234 204 53 Anello pieno c ø57,3x50
- 234 204 54 Anello pieno d ø85x30
- 234 204 55 Anello pieno e ø85 3perni
- 234 204 56 Barra filett.acc.b7 m12x350
- 234 204 57 Cusc.reg/spinta cad.
- 234 204 58 Bicchiere x cusc.r/spinta
- 234 059 Tondo guida

**Estrattore / Introduttore Silentblock su Panda N
power Metano 4 x 4**

Extraction silent block Fiat Stilo & Bravo new



Introduttore



Estrattore



234 204 70 Kit A.F.A

Attrezzo montaggio boccole elastiche bracci oscillanti sospensione anteriore

Tool rear suspension swinging arm bushing



- 234 205 127-A112-128-500-Uno-Regata
- 234 206 127-A112

Attrezzo montaggio boccole elastiche barra stabilizzatrice posteriore

Tool stabilizer bar bushing



234 207 Croma

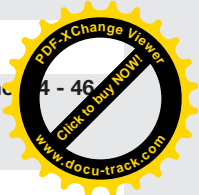
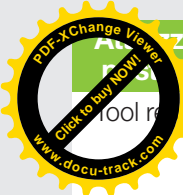

Attrezzo montaggio boccole elastiche ponte

ore

suspension swinging arm bushing



234 210 Volvo 240

Attrezzo montaggio boccole elastiche sospensione anteriore

Tool front suspension swinging arm bushing



234 211 Daily-Grinta

Chiave ghiera boccole elastiche sospensione anteriore

Wrench nutl front suspension swinging arm bushing



234 212 Daily-Grinta - 32 x 28 x 4

Chiave ghiera cuscinetto braccio sospensione

Wrench nut swinging arm suspension



234 213 Peugeot 205 - 69 x 49 x 6,5

Kit in valigia di plastica per estrazione ed inserimenti cuscinetti, silentblock e boccole



234 215 28 Pz

Composizione - Composition

- 20 Boccole Ø interno: 34 - 36 - 38 - 70 - 72 Ø esterno: 44 - 46 - 48 - 80 - 82
- 4 - Step disc
- 4 - Viti estrazione con dado



Ricambi - Spare-parts



234 215 10 Vite M10 con 2 cuscinetti reggi spinta



234 215 12 Vite M12 con 2 cuscinetti reggi spinta



234 215 14 Vite M14 con 2 cuscinetti reggi spinta



234 215 16 Vite M16 con 2 cuscinetti reggi spinta

Kit in valigia rigida per estrazione / inserimento cuscinetti, Silentblock e boccole

Press-on sleeve kit



234 218 Pz 24

Composizione - Composition



- 20 Boccole: Ø Interno / Esterno: 34/44 - 36/46 - 38/48 - 40/50 - 42/52 - 44/54 - 46/56 - 48/58 - 50/60 - 52/62 - 54/64 - 56/66 - 58/68 - 60/70 - 62/72 - 64/74 - 66/76 - 68/78 - 70/80 - 72/82
- 4 Viti estrazione + dado e cuscinetto: M10 - M12 = M14 - M16

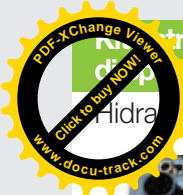

Kit estrattore boccole idraulico con capacità di spinta pari a 12 Ton. - In trolley -

Hidraulic 12 ton. steering sistem pull toll set - In trolley



CM 90

Pratica valigia con ruote



CM 50

234 220 Universale - Trolley Kg 31

Composizione - Composition

- Fila 1 - 28x20 - 32x24 - 36x28 - 40x32 - 44x36 - 48x40 - 50x42 - 52x44 - 56x48 - 60x52 - 64x56 - 68x60 (Altezza mm 40)
- Fila 2 - 68x60 - 64x56 - 60x52 - 56x48 - 52x44 - 48x40 - 44x38 - 42x34 - 40x32 - 38x28 - 32x24 - 28x20 (Altezza mm 110)
- Fila 3 - 66x58 - 62x54 - 58x50 - 54x46 - 50x42 - 46x38 - 38x30 - 34x26 - 30x22 - 26x18 (Altezza mm110)
- Fila 4 - 26x18 - 30x22 - 34x26 - 38x30 - 42x34 - 46x38 - 54x46 - 58x50 - 62x54 - 66x58 (Altezza mm 40)

NOTE



www.afasupport.it

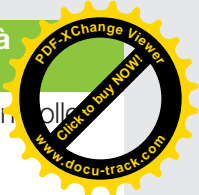

Kit estrattore boccole idraulico con capacità di spinta pari a 12 Ton. - In trolley -

Hidraulic 12 ton. steering sistem pull toll set - In trolley



Tubo idraulico

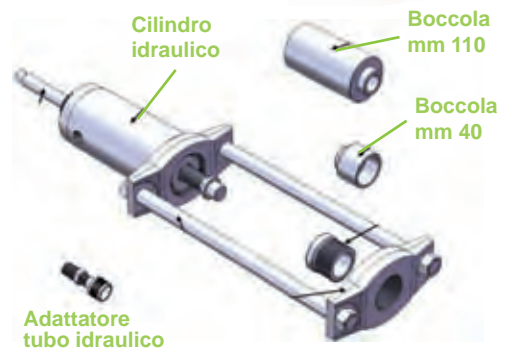

CM 90

Pratica valigia con ruote



CM 50

234 221 Universale - Trolley Kg 31

Composizione - Composition

- Fila 1 - 28x20 - 32x24 - 36x28 - 40x32 - 44x36 - 48x40 - 50x42 - 52x44 - 56x48 - 60x52 - 64x56 - 68x60 (Altezza mm 40)
- Fila 2 - 68x60 - 64x56 - 60x52 - 56x48 - 52x44 - 48x40 - 44x38 - 42x34 - 40x32 - 38x28 - 32x24 - 28x20 (Altezza mm 110)
- Fila 3 - 66x58 - 62x54 - 58x50 - 54x46 - 50x42 - 46x38 - 38x30 - 34x26 - 30x22 - 26x18 (Altezza mm110)
- Fila 4 - 26x18 - 30x22 - 34x26 - 38x30 - 42x34 - 46x38 - 54x46 - 58x50 - 62x54 - 66x58 (Altezza mm 40)

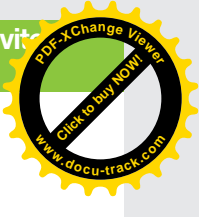
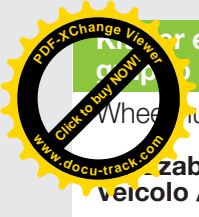

**Strumenti per estrazione inserimento cuscinetti del
VAG**



234 250 Pz 15

Dati tecnici - Informative

- Audi A2 dal 2000 / Skoda Fabia dal 2000
- Vw Polo dal 2002 / Seat Ibiza dal 2000
- Fox dal 2005

Spurgafreni e frizioni a membrana



Terza camera di riserva per più operazioni a pressione costante dotata di due taniche recupero olio e imbuto di riempimento. Senza tappi in dotazione.

234 907
Capacità olio (camera superiore) - 5 Litri -
Max bar utilizzo (camera centrale) - 2 bar
Max bar riserva (camera inferiore) - 10 bar -
Lunghezza tubo erogazione - 3 Mt
Valvola di sicurezza - 10 bar

Spurgafreni e frizioni a membrana



Terza camera di riserva per più operazioni a pressione costante dotata di due taniche recupero olio e imbuto di riempimento. Dotazione tappi standard.

234 908
Capacità olio (camera superiore) - 5 Litri
Max bar utilizzo (camera centrale) - 2 bar
Max bar riserva (camera inferiore) - 10 bar
Lunghezza tubo erogazione - 3 Mt
Valvola di sicurezza - 10 bar

**Serie tappi standard composta da 5 tappi a vite
(A-D-F-I-T) ed un tappo universale (W)**



234 909

Tanichetta recupero olio freni



234 910 Tanichetta
234 910 01 Tubo di ricambio

Serie tappi extra a vite (B-C-E-G-H-K-L-M-P-R-U-X-Y-Z)



234 911

Spurgafreni pneumatico



235 045

Ricambi - Spare-parts



235 045 01 Attacco con pipetta
235 041 Solo pipetta

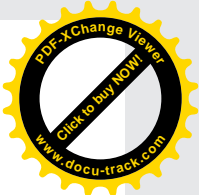
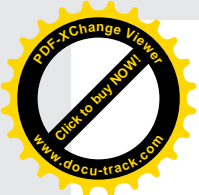

| LETTURA CODICI | | ↓ | ↓ | ↓ | ↓ | ↓ | ↓ | ↓ | ↓ | ↓ | ↓ | ↓ | ↓ | ↓ | ↓ | ↓ | ↓ | ↓ | ↓ | ↓ |
|----------------|---|---|---|---|---|---|---|---|---|---|---|---|---|---|---|---|---|---|---|---|
| | | 2 | 2 | 2 | 2 | 2 | 2 | 2 | 2 | 2 | 2 | 2 | 2 | 2 | 2 | 2 | 2 | 2 | 2 | 2 |
| | | 3 | 3 | 3 | 3 | 3 | 3 | 3 | 3 | 3 | 3 | 3 | 3 | 3 | 3 | 3 | 3 | 3 | 3 | 3 |
| | | 4 | 4 | 4 | 4 | 4 | 4 | 4 | 4 | 4 | 4 | 4 | 4 | 4 | 4 | 4 | 4 | 4 | 4 | 4 |
| | | 9 | 9 | 9 | 9 | 9 | 9 | 9 | 9 | 9 | 9 | 9 | 9 | 9 | 9 | 9 | 9 | 9 | 9 | 9 |
| | | 1 | 1 | 1 | 1 | 1 | 1 | 1 | 1 | 1 | 1 | 1 | 1 | 1 | 1 | 1 | 1 | 1 | 1 | 1 |
| | | 1 | 1 | 1 | 1 | 1 | 1 | 1 | 1 | 1 | 1 | 1 | 1 | 1 | 1 | 1 | 1 | 1 | 1 | 1 |
| | | 0 | 0 | 0 | 0 | 0 | 0 | 0 | 0 | 0 | 1 | 1 | 1 | 1 | 1 | 1 | 1 | 1 | 1 | 1 |
| | | 1 | 2 | 3 | 4 | 5 | 6 | 7 | 8 | 9 | 0 | 1 | 2 | 6 | 7 | 3 | 4 | 8 | 5 | 9 |
| A | B | C | D | E | F | G | H | I | K | L | M | P | R | T | U | X | W | Z | | |

| A U T O V E T T U R E | ALFA | | | | | | | | | | | | | | | | | | | | |
|---|---------------|--|--|--|--|--|--|--|--|--|--|--|--|--|--|--|--|--|--|--|--|
| | AUDI | | | | | | | | | | | | | | | | | | | | |
| | AUSTIN MORRIS | | | | | | | | | | | | | | | | | | | | |
| | AUTOBIANCHI | | | | | | | | | | | | | | | | | | | | |
| | BMW | | | | | | | | | | | | | | | | | | | | |
| | CITROEN | | | | | | | | | | | | | | | | | | | | |
| | DAF | | | | | | | | | | | | | | | | | | | | |
| | FERRARI | | | | | | | | | | | | | | | | | | | | |
| | FIAT | | | | | | | | | | | | | | | | | | | | |
| | FORD | | | | | | | | | | | | | | | | | | | | |
| | INNOCENTI | | | | | | | | | | | | | | | | | | | | |
| | JAGUAR | | | | | | | | | | | | | | | | | | | | |
| | LAMBORGHINI | | | | | | | | | | | | | | | | | | | | |
| | LAFER | | | | | | | | | | | | | | | | | | | | |
| | LADA | | | | | | | | | | | | | | | | | | | | |
| | LANCIA | | | | | | | | | | | | | | | | | | | | |
| | LAND ROVER | | | | | | | | | | | | | | | | | | | | |
| | LEYLAND | | | | | | | | | | | | | | | | | | | | |
| | MASERATI | | | | | | | | | | | | | | | | | | | | |
| | MITSUBISHI | | | | | | | | | | | | | | | | | | | | |
| | MATRA | | | | | | | | | | | | | | | | | | | | |
| MAZDA | | | | | | | | | | | | | | | | | | | | | |
| MERCEDES | | | | | | | | | | | | | | | | | | | | | |
| NISSAN | | | | | | | | | | | | | | | | | | | | | |
| NSU | | | | | | | | | | | | | | | | | | | | | |
| OPEL | | | | | | | | | | | | | | | | | | | | | |
| PEUGEOT | | | | | | | | | | | | | | | | | | | | | |
| PORSCHE | | | | | | | | | | | | | | | | | | | | | |
| RENAULT | | | | | | | | | | | | | | | | | | | | | |
| ROVER | | | | | | | | | | | | | | | | | | | | | |
| SAAB | | | | | | | | | | | | | | | | | | | | | |
| SEAT | | | | | | | | | | | | | | | | | | | | | |
| TALBOT | | | | | | | | | | | | | | | | | | | | | |
| TOYOTA | | | | | | | | | | | | | | | | | | | | | |
| TRIUMP | | | | | | | | | | | | | | | | | | | | | |
| VAUXHALL | | | | | | | | | | | | | | | | | | | | | |
| VOLKSWAGEN | | | | | | | | | | | | | | | | | | | | | |
| VOLVO | | | | | | | | | | | | | | | | | | | | | |

| T R U C K | ASTRA | | | | | | | | | | | | | | | | | | | | | |
|-----------------------|--------------|--|--|--|--|--|--|--|--|--|--|--|--|--|--|--|--|--|--|--|--|--|
| | BEDFORD | | | | | | | | | | | | | | | | | | | | | |
| | BERLIET | | | | | | | | | | | | | | | | | | | | | |
| | DAF | | | | | | | | | | | | | | | | | | | | | |
| | EBRO | | | | | | | | | | | | | | | | | | | | | |
| | FIAT | | | | | | | | | | | | | | | | | | | | | |
| | FORD | | | | | | | | | | | | | | | | | | | | | |
| | MAGIRUS | | | | | | | | | | | | | | | | | | | | | |
| | MERCEDES | | | | | | | | | | | | | | | | | | | | | |
| | PEGASO Comet | | | | | | | | | | | | | | | | | | | | | |
| | RENAULT | | | | | | | | | | | | | | | | | | | | | |
| | SAVIEM | | | | | | | | | | | | | | | | | | | | | |
| | SCANIA | | | | | | | | | | | | | | | | | | | | | |
| | UNIC | | | | | | | | | | | | | | | | | | | | | |
| VOLVO | | | | | | | | | | | | | | | | | | | | | | |

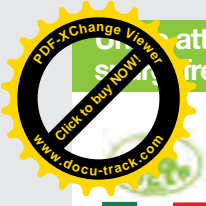

Attrezzo per riempimento filtro gasolio e freni pneumatico



235 046 Completo di tubi e raccordi

Ricambi - Spare-parts

235 041 Solo pipetta

235 045 01 Attacco con pipetta

235 046 01 Tubo Ø6

235 046 02 Tubo Ø8

235 046 03 Raccordo maschio Ø9

235 046 04 Raccordo maschio Ø9,5

Chiavi doppie per raccordi tubetti freno

Wrench for operating on brake connectors



235 065 8x9 mm

235 066 10x11 mm

235 068 14x17 mm

Kit di spurgo e recupero olio freni

Kit for draining oil brakes



235 053

NOTE



Chiavi per raccordi tubetti freno

Wrench for operating on brake connectors



235 054 Set 7 pcs 8-9-10-11-12-13-14

Ricambi - Spare-parts

235 055 8 mm 235 059 12 mm

235 056 9 mm 235 060 13 mm

235 057 10 mm 235 061 14 mm

235 058 11 mm

Chiave da 11 fissa e snodata per condotti freni con molla apri e chiudi brevettata

Brake pipe wrench



235 070

Chiave registro freni

Wrench adjusting brakes



235 076 Mini Minor

Chiave registro freni

Wrench adjusting brakes



235 077 Simca 1000

Chiave registro freni

Wrench adjusting brakes



235 078 Citroen GS

Chiave registro freni

Wrench adjusting brakes



235 079 Alfa Sud - 17 mm

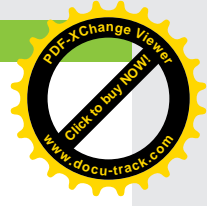

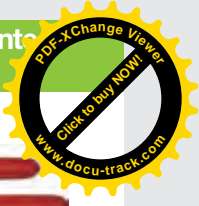
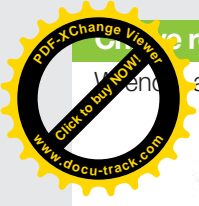

registro freni

Wrench adjusting brakes



235 080 Fiat - 17 mm

Chiave registro freni

Wrench adjusting brakes



235 081 Renault-Peugeot-Citroen - 1/2" - Penta

Chiave registro freni

Wrench adjusting brakes



235 082 Renault-Peugeot-Citroen - Penta

Chiave registro freni

Wrench adjusting brakes



235 083 Renault - 10 mm

Chiave registro freni

Wrench adjusting brakes



235 084 Renault - 10 mm

Set 6 chiavi raccordi tubi freno

6pcs brake bleeder wrench



235 085 In valigetta

Composizione - Composition

| | | |
|---------|----------------------|---------------|
| Chiave: | Esagono aperto 5/16" | Quadro 1/4" |
| Chiave: | Esagono aperto 7/16" | Quadro 11/32" |
| Chiave: | Quadro 1/4" | Quadro mm 10 |
| Chiave: | Esagono 1/4" | Esagono mm 7 |
| Chiave: | Esagono mm 8 | Esagono mm 10 |
| Chiave: | Esagono mm 9 | Esagono mm 11 |

Pinza piegatura tubetti freno sostegno durante il taglio o il montaggio

Plier for aid brake connectors



235 090 4,75 mm

Attrezzo montaggio molle ganasce freni posteriori al porta ceppi

Tool for refitting brake shoe retaining spring



235 091 Fiat

Estrattore dischi freno

Puller for brake disc



235 099 Fiat 127-128-131-Ritmo.

Estrattore tamburi freno

Puller for flange axle



235 100 Fiat 127

Estrattore tamburi freno

Puller for flange axle



235 101 Alfa Sud

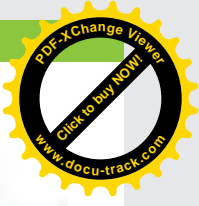
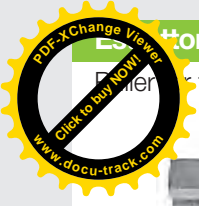

Estrattore tamburi freno

Puller for flange axle



235 102 apertura 150-350 mm / profondità 125 mm

Estrattore tamburi freno

Puller for flange axle



235 105 FIAT

Estrattore tamburi freno con zampe registrabili

Puller for flange axle



235 106 Universale

Attrezzo arretramento pistoncini freno

Equip withdrawal piston brake



235 112

Attrezzo rotazione pistoncini freno

Tool for rotating brake disc piston



235 120 Uno turbo ie - 28 x 18 x 7 conico

Attrezzo rotazione pistoncini freno

Tool for rotating brake disc piston



235 121 Alfa 33-164 28 x 18 x 7 conico
35 x 26 x 6 conico

Attrezzo rotazione pistoncini freno

Tool for rotating brake disc piston



235 122 Croma - 37 x 24 x 7 conico

Estrattore tamburi freno

Puller for flange axle

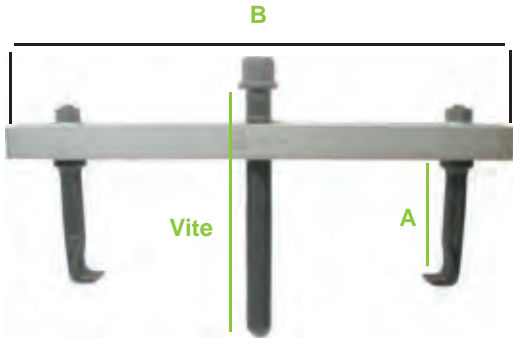

235 103
A mm 95 B mm 380 Vite mm 195

Adattatori opzionali - Optional adaptor



111 033 01 Prolunga



Con prolunga optional mm 195

Estrattore tamburi freno

Puller for flange axle



235 104 Diametro max 120 mm

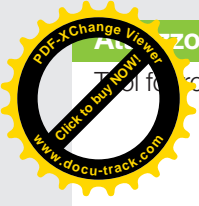

Attrezzo rotazione pistoncini freno

Tool for rotating brake disc piston



235 123 Renault

Attrezzo rotazione pistoncini freno

Tool for rotating brake disc piston



235 124 Bravo-Coupè-Barchetta-Kappa

Attrezzo rotazione pistoncini freno

Tool for rotating brake disc piston



235 130 Universale - 3/8"

Set bussole pentagonali per pinze freni. Att. 1/2"

3 pcs 1/2" pentagon socket



1/2"

235 134 Pz. 3

Ricambi - Spare-parts



| | | A | B |
|---------|-------------------|-------|---------|
| 235 081 | Pentagono maschio | mm 10 | mm 7 |
| 235 135 | Pentagono femmina | mm 14 | mm 10 |
| 235 136 | Pentagono femmina | mm 19 | mm 1/2" |

Set rotazione pistoncini freno Dx / Sx

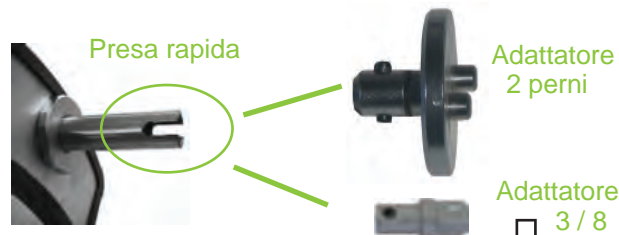
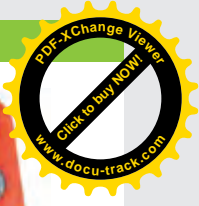
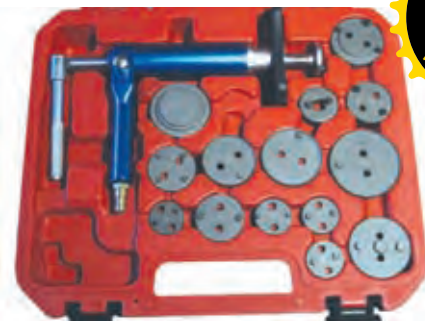

- 235 137 Kit in valigetta senza presa rapida
- 235 137 05 Kit in valigetta con presa rapida

Ricambi - Spare-parts

- 235 137 01 Solo pistola senza presa rapida
- 235 137 06 Solo pistola con presa rapida
- 235 137 07 Solo adattatore 2 perni
- 235 137 08 Solo adattatore □ 3 / 8

Adattatori opzionali - Optional adaptor



Adattatore ribassato intercambiabile con nostro attrezzo pneumatico per rotazione pistoncini freni a disco, da utilizzare in presenza di pastiglie usurate
 Adaptor for pneumatic piston brake



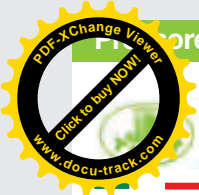

Pressore per cilindretti freno



235 137 20 Ford Focus / C-Max - Attacco 2 fori

Pressore per cilindretti freno

Adapter

235 137 21

235 137 22

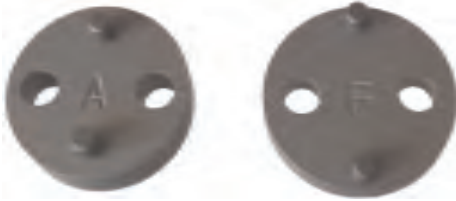

235 137 21 Pastiglia Ø30 con spine Ø 4

235 137 22 Pastiglia Ø32 con spine Ø 4

Pressore per cilindretti freno



235 137 50 Iveco Daily - Attacco 2 fori

Set rotazione pistoncini freno per auto giapponesi ed europee e USA

Kit rotation brake pistons for Japanese, EU and USA cars



235 138 Rotazione destra

NOTE



Blank lines for notes

Attrezzo rotazione pistoncini freno destro e sinistro

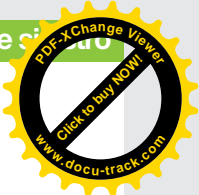

Citroen/XM,Xantia,Audi,FIAT/Alfa Romeo,FordFiesta - ISUZU,HONDA/Concesto. Jaguar/XJ6,XJ40BMW/318is - 320i, 325TD, 518i, 525i & lx, 740i, 850ci, M5 - Mercedes Benz 190, 200, 300, 420,560,MitsubishiColt - NISSAN/ Mlera Stanza, Sunny,Rover Austin, Metro, 200 - 400,Maestra,Montego,TOYOTA Camry,Volvo, VW - Passat,Golf GTI, FORD Australia, NZ,Telstar, Laser - MAZDA,SAAB 9000, FIAT/Alfa Romeo 164 2.0 - HONDA/Prelude, CRX 16i,GM/ Saturn,NISSAN - PRIMERA, VW/Golf IV,Audi 80, 90, V8, 100, Coupe - Rover 800 ABS, SUBARU L+Z, FORD Sierra ABS - Granada, Scorpio ABS 85, NISSAN Bluebird 1.8 - Turbo, Silvia Turbo Primera 2.0i LS/GS/GSX - PEUGEOT/405 1.9Gi, Gri,Sri, Gtxi, MI 16, 605 2.0 - Sri,TOYOTA Celica, Corolla GT, MR2, VW/Golf Gti, Jetta - Synchro, Jetta Gti 16V, Passat CL, GL, GT and GT 16V - Corrado 16V,Scirrocco GTX 16V,GM most 1-7/8" diameter pistons GM most 2-1/8" diameter pistons GM most 2-1/2" diameter pistons Renault R21 - Laguna, Ford Modeo - SAAB - Honda.Open - Citroen, NISSAN Maxims.

235 139

Attrezzo rotazione pistoncini freni

Rotation brake pistons



mm 155

235 139 Dx "Destro"

235 139 Sx "Sinistro"

Set rotazione pistoncini freni destro



235 140 in valigetta



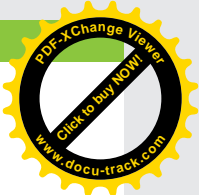
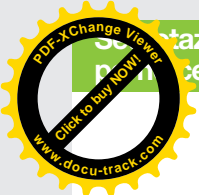

Stazione pistoncini freno destro e sinistro con centrale sfilabile in caso di blocco attrezzo



235 140 10 Kit completo - 14 Pz

Composizione - Composition

- 235 141** Estrattore completo destro - 3/8
- 235 141 01** Estrattore completo sinistro - 3/8
- 235 142** Esagono - 12 mm
- 235 143** Diam 31.5 - 2 perni diam 5 mm
Interasse 21 mm
- 235 144** Diam 35 - 2 perni diam 6 mm
Interasse 21 mm
- 235 145** Diam 41 - 2 perni diam 6 mm
Interasse 34 mm
- 235 146** Diam 44 - 2 perni diam 6 mm
Interasse 33 mm
- 235 147** Diam 52 - 3 perni diam 6 mm
Interasse 44 mm
- 235 148** Snodo Diam 66 - diam interno 33 mm 44 mm
- 235 149** Piastrina
- 235 150** Diam 36 - Fiat Stilo e Multipla
- 235 151** Diam 45 - Fiat Ducato
- 235 152** Diam 35 - Alfa Romeo
- 235 153** Diam 28 - Alfa Romeo - Audi - Volkswagen

Ghiera per arretramento pistoncini freni

Ferrule for withdrawal little pistons you brake



235 150 Fiat Stilo - Ø36

Pressore per cilindretti freno per Renault Laguna

Ferrule for withdrawal little pistons you brake



235 150 01 Attacco - 3/8"

Pressore per cilindretti freno per Audi 100

Ferrule for withdrawal little pistons you brake



235 150 02 Attacco - 3/8"

Pressore per cilindretti freno per Citroen BX

Ferrule for withdrawal little pistons you brake



235 150 03 Attacco - 3/8"

Pressore per cilindretti freno per Citroen C 5 - C 6



235 150 04 C 5 - Cilindretto destro - Attacco - 3/8"

235 150 05 C 6 - Cilindretto sinistro - Attacco - 3/8"

Pressore per cilindretti freno per Ford Focus



235 150 06 Attacco - 3/8"

Pressore per cilindretti freno per Nissan



235 150 07 Attacco - 3/8"

Pressore per cilindretti freno per Subaru



235 150 08 Attacco - 3/8"

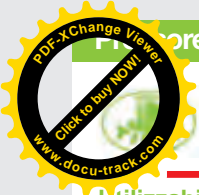

3 denti per cilindretti freni Ford



Utilizzabile con art. 235 14010

235 150 20 Attacco - 3/8"

Ghiera per arretramento pistoncini freni

Ferrule for withdrawal little pistons you brake



235 151 Daily - Ø45

Ghiera per arretramento pistoncini freni

Ferrule for withdrawal little pistons you brake



235 152 Alfa Romeo - Ø35

235 153 Alfa Romeo - Audi - VW - Ø28

Nuovi piattelli per 235 140 e 235 14010 per vetture BMW



235 154 01 BMW serie 3 e 5 ultimo tipo

235 154 02 Mini By BMW

235 154 03 BMW 1° serie

Attrezzo per comprimere pistoncini freno

Tool for retain brake disc piston



235 155 Fiat 131-132-124-125-127-Panda-Ritmo

Chiave ganasce freni

Wrench for refitting dampers



235 157 Alfa 33 4x4 - 8 mm

Chiave per ghiera anello di comando freni

Wrench for adjusting brakes nuts



235 158 Audi - 28 x 18 x 4

Chiave per montaggio pinze freni

Wrench for refitting disc brake



235 161 Peugeot-Renault-Citroen - 5 lati 19 mm

Attrezzo per ceppi freno

Tool for brakes



235 165 Universale

Attrezzo doppio per molle ceppi freno

Tool double for dampers

con cappuccio antinfortunistico



235 167 Universale

Attrezzo per molle ceppi freno

Tool for dampers



235 168 Universale

Chiave a bussola pinze freni Audi e Volkswagen



235 169 XZN forato - M 14

Pinza molle freni

Plier for refitting dampers



235 170 Universale - 220 mm

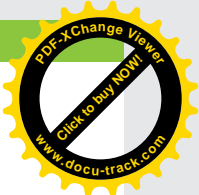

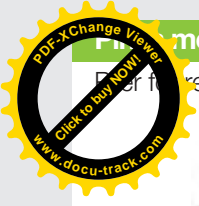

Pinze molle freni a tamburo

Pliers for refitting dampers



235 174 Universale - 320 mm

Pinza molle freni con estrattore tenuta molle

Plier for refitting dampers



235 176 Universale - 330 mm

Pinza per cavo freno a mano

Plier for brake



235 180

Pinza per molle ganasce freni a tamburo

Plier for brake hubs spring

Made in Germany



235 182 mm 230

Pinza per molle freni autocarro

Brake spring pliers



mm 540

235 185 mm 540

235 185 01 Gancio di ricambio

Kit per ripristino filetti freni a disco V.A.G. Opel - Ford

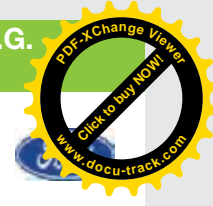

235 195 In valigetta



Chiave regolazione freni Audi, Penta Tx - forata



Att.

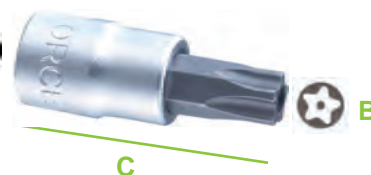

3/8"

C

| | Att. | B | C |
|---------|------|-------|-------|
| 235 286 | 3/8" | Ts 55 | mm 48 |

NOTE

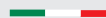

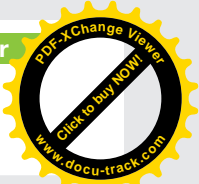
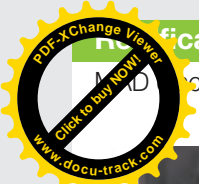

Macchina per dischi freni MAD

Macchina aligner



235 300

Un vero e proprio tornio per risolvere i problemi causati da usura irregolare o decentrata, senza smontare il disco della vettura

Composizione - Composition

Motore con carrello + Tornio con materiale di fissaggio 1 serie di placchette (235 312) + 1 piastra rotaz. ruota (235 305)

Dati tecnici - Informative

Il metodo della rettifica "sul veicolo" è opportuno in tutti quei casi in cui l'usura irregolare o decentrata dei dischi freno provoca ruvidità di frenata o vibrazioni del volante, ed è estremamente pratico in quanto permette la lavorazione dei dischi dei freni senza che vengano smontati dal veicolo! Non a caso il tornio dischi freni "MAD" è approvato e usato da molte delle maggiori case automobilistiche, tra cui il gruppo Fiat.

- Conforme alle norme di sicurezza europee (CE) e alle norme IEC-1029-1/CSA

- Costruito con tecnologie avanzate; è altamente preciso per via della doppia guida brevettata che consente risultati abbondantemente inferiori alle tolleranze indicate dalle case automobilistiche

- Può essere montato facilmente su ogni tipo di autovettura, fuoristrada e furgone grazie alle speciali piastre di montaggio. - L'adattatore di trasmissione è unico per tutti i tipi di veicoli.

- E' fornito con utensili da taglio a forma triangolare a lunga durata. - Venduto in ben 60 Stati.

Composizione - Composition



235 305

Staffa trascinalimento per unità di comando



235 312

Utensili da taglio triangolari con profilo positivo e vite - Pz 2

Adattatori opzionali - Optional adaptor



235 301

Slitta montaggio universale Rossa, per portapinzine non filettate

235 302

Slitta montaggio universale Blu, per portapinzine filettate

Adattatori opzionali - Optional adaptor



235 303

Prolunga per slitta rossa

235 304

Prolunga per slitta blu



235 305 01

Staffa di trascinalimento da applicare all'unità di comando per i veicoli fuoristrada e dei furgoni



235 308

Anello antivibrante Giallo Ø 220 x 24, per dischi da Ø 240 a 350 mm, riduce il rumore e ottiene una finitura liscia

235 309

Anello antivibrante Rosso Ø 220 x 8, per dischi da Ø 240 mm, riduce il rumore e ottiene una finitura liscia

235 310

Anello antivibrante Grigio Ø 160 x 8, per dischi da Ø 175 a 240 mm, riduce il rumore e ottiene una finitura liscia



235 311

Utensili da taglio triangolari + vite. Profilo piatto - Pz 2

235 311 10

Utensili da taglio triangolari + vite. Profilo piatto - Pz 10

235 312 10

Utensili da taglio triangolari + vite. Profilo positivo - Pz 10

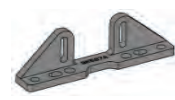

235 315

Adattatore freni radiale, per freni radiali montati su: Ferrari - Lexus - Porsche - Audi - Vw - BolkIT richiesto dalla marca dell'automobile

Set montaggio / smontaggio freni

High quality brake tool set



236 000

Contiene: Pinze per molle freni - Pinza per cavo freno a mano - 2 spazzole - Perni per rimuovere lo sporco - Utensili per molle freni a mano - Utensili per molle freni a tamburo - Cacciavite a snodo - Chiave per tubetti freni. Chiave registro freni.

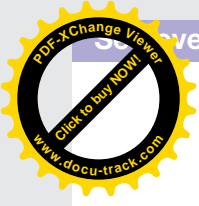

Impugnatura in nylon e fibra di vetro



240 000 4 Pz

Kit attrezzi in teflon per carrozzeria, indicati in modo particolare per macchine d'epoca



240 049

Composizione - Spare parts

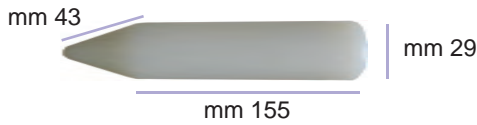

240 050 Supposta in teflon

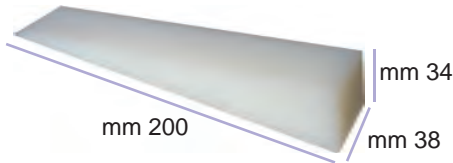

240 051 Cuneo in teflon

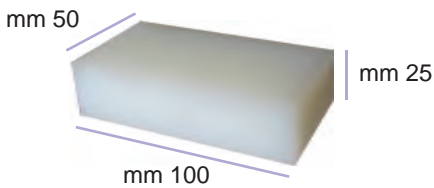

240 052 Saponetta in teflon

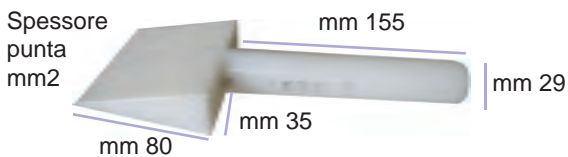

240 053 Impugnatura con cuneo in teflon - Punta fine

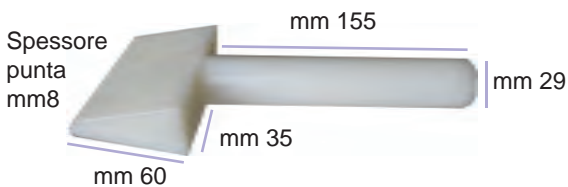

240 054 Impugnatura con cuneo in teflon - Punta grossa

Impugnatura a martello in teflon



240 055 Punta fine

Impugnatura a martello in teflon



240 056 Punta grossa

Mazzuolo in teflon

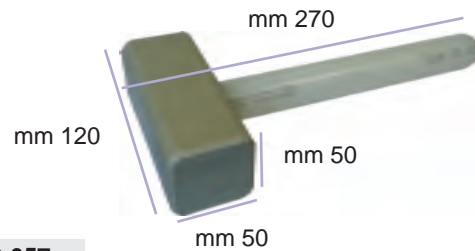

240 057

Attrezzo levabottoni tipo largo con invito sulle punte

Tool dismantling pannel doors cups



241 000 Universale

Attrezzo leva bottoni portiere

Tool dismantling pannel doors cups



241 001 Universale

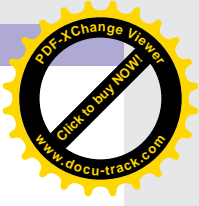

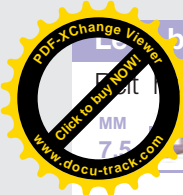

bottoni modello stretto

ok tool



MM 280



241 001 01

Attrezzo leva bottoni portiere Teflon

Tool dismantling panel doors cups Teflon



241 002 Universale - mm 140

241 002 01 Universale Lunga - mm 300

Attrezzo leva bottoni portiere piegata

Tool dismantling panel doors cups



241 004

Attrezzo leva bottoni portiere ripiegata a gancipunte

Tool dismantling panel doors cups



241 005

Attrezzo leva bottoni portiere a gancio

Tool dismantling panel doors cups



241 006

Set leve per la rimozione selleria - bottoncini - bordature - pannelleria



241 007 Leve in teflon - Pz 5

Set scalpelli per rimozione modanature in gomma /alluminio

4 pcs plastic scraper set



mm 19

mm 22

mm 24

mm 38

241 007 10 Leve in Nylon - P 4

Set leve per carrozzieri

| | | |
|---|-----|--------------|
| A | 45g | 170x66x24mm |
| B | 55g | 180x66x6mm |
| C | 35g | 176x75x5mm |
| D | 45g | 200x30x6mm |
| E | 20g | 176x21x5mm |
| F | 45g | 211x20x7.5mm |
| G | 25g | 166x33x6mm |
| H | 20g | 202x30x6.5mm |
| I | 20g | 198x34x5mm |
| J | 10g | 200x24x4mm |
| K | 10g | 202x24x4mm |
| L | 15g | 202x15x5mm |



241 007 12 In valigetta - Pz 12

Leva in acciaio a lamina sottile con manico plasticato per pannelli auto



241 008

Leva in teflon curva per pannelli auto



241 008 10

Leva/cuneo in teflon per pannelli e rivetti selleria auto



241 008 12

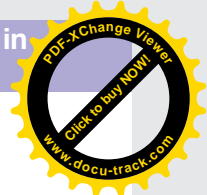

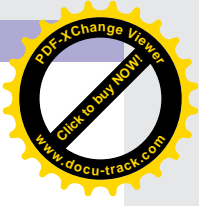
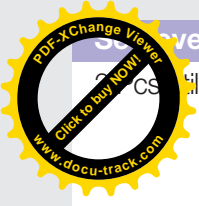

Leve in teflon per pannelli auto

Flexibility wedge set



241 009 Set leve 3 Pz

Ricambi - Spare parts

- 241 009 01** mm 22
- 241 009 02** mm 30
- 241 009 03** mm 60

Pinza levabottoni



mm 240

241 010 01

Attrezzo leva bottoni portiere

Tool dismantling panel doors cups



241 011 Alfa Romeo

Attrezzo smontaggio alzacristallo

Tool dismantling window inner



241 015 Fiat-Lancia-Alfa

Attrezzo smontaggio maniglie alzacristallo

Tool dismantling window inner handle



241 016 Universale

Attrezzo smontaggio rasacristallo

Tool dismantling window cut inner



241 017 Fiat-Alfa-Lancia

Leva apriporta

Lever for open door



241 018 Universale

Kit apri portiera a soffietto



241 019 3 pz

Chiave doppia a cricchetto per smontaggio perni cerniere portiere

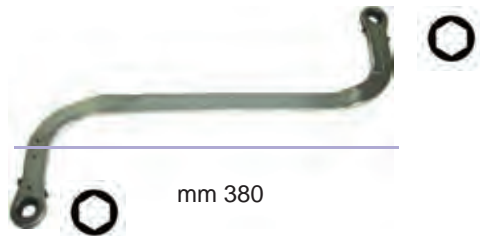

mm 380

241 020 mm 14 x 380

Leva per portiere

Levers for doors

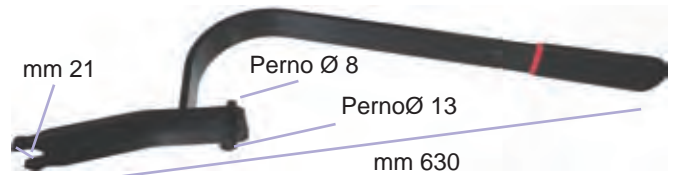

241 025

Kit smontaggio perni cerniere porte

Kit dismantling door hinge pin



- 241 021** Universale - 4-5-6 mm
- 241 022** Perno ricambio - 4 mm
- 241 023** Perno ricambio - 5 mm
- 241 024** Perno ricambio - 6 mm

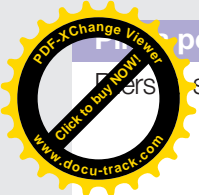

per raddrizzare profili portiere

straighten profiles doorman



241 026

Chiave smontaggio dadi cerniere porte

Wrench for nuts hinge door



241 029 XZN 10

Chiave dadi sostegno portiere

Wrench for dismantling nuts front door



241 030 Tipo-Nuova Uno-Dedra-Tempra Uno - 8 mm

241 031 Chiave senza inserti

Leva per montaggio listelli tettuccio

Lever dismounting sheed



241 032 Golf

Tiralamiere con battitoio a 2 ganci intercambiabili. Impugnatura con protezione mano operatore

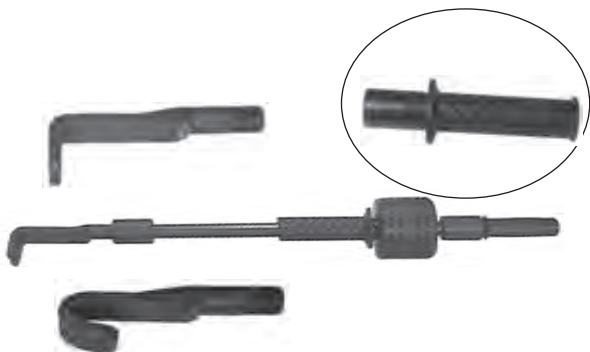

241 034 mm 720

Estrattore a leva

Puller for body



241 035 Universale

Pulitore per ugelli lavavetri

Windshield spray nozzle



241 036

Coppia leve per guarnizioni

Trim tool for rubber doors



241 037 Universale - Ford Opel

Set universale estrattori Kukko per tergicristalli



241 038 KS 142 / 6

Set ganci rimozione guarnizioni

Special designe to remove hose easily



241 039 Pz 2

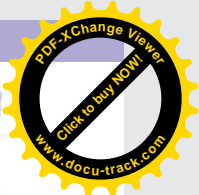

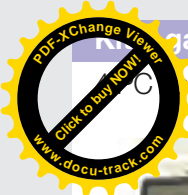

Ganci in acciaio Inox con impugnatura

Hook & pick set Plastic box and soft case

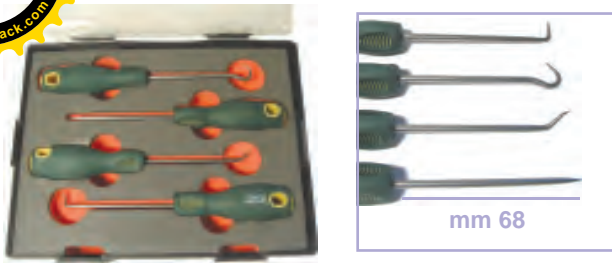

241 041 Box plastica formato soft

Set 4 ganci acciaio inox con impugnatura



241 042 5 Pz

Kit ganci per rimozione guarnizioni / O-Ring

3Pcs seal puller set

Acc. Nikelato

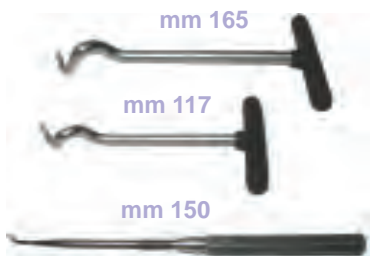

241 042 10 in blister - Pz 3

Ricambi - Spare parts

241 042 11 mm 165

241 042 12 mm 117

241 042 13 mm 150

Ventosa



241 043 Ø125

Ventosa di grande presa su superfici verniciate lisce e su vetri auto per brevi spostamenti. Sgancio ventosa con leva di scarico vuoto.

Coppia ventosa per vetri portiera

Suction cups for car glasse



241 045 Universale

Cinghia a cricchetto

Belt with ratchet



241 048 4 mt

Kit Lamine sostegno vetro durante il montaggio

Kit Blades for car-glasses



241 049 INOX

Kit smontaggio/montaggio parabrezza universale

Universal Kit for car glasses



241 050 Kit smontaggio/montaggio parabrezza

241 051 Completo di 241 049

Attrezzo smontaggio parabrezza

Tool dismanting windows



241 060 Universale

241 061 Lama ricambio

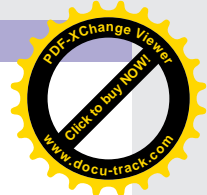

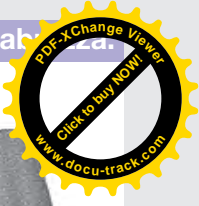
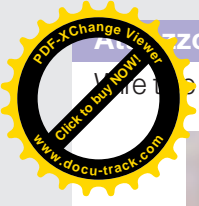

Kit smontaggio parabrezza a filo quadro

Kit dismantling windshield



241 062 Universale

241 063 Filo di ricambio quadro mt 25

Filo a sezione quadrata per rimozione vetri vetture

Square wire for car-glasses



241 064 mt.50

Filo sezione triangolare per rimozione vetri vetture

Windschield cut-out wire stainless steel - (Triangle)

Sez 0,66 mm2



241 064 01 Mt 50

Attrezzo trascinafilo per art. 241 064 - 241 063

Tool for 241 064 - 241 063



241 065

Kit smontaggio parabrezza

Kit dismantling windows



241 070 Universale

Ricambi - Spare parts

241 071 Coppia impugnature sagomate tira filo

241 073 Lama lunga con impugnatura

Punteruolo per foratura e tirafilo per parabrezza

Awl for perforation and wire for windscreen



241 074

Leva per montaggio vetri vetture

Wrench for car glass



241 076 Tipo-Nuova Uno-Dedra-Tempra Uno - 8 mm

241 077 Leva destra

241 078 Leva sinistra

Kit coltelli per carrozzieri

3 Pcs seam buster set (Staight + curve + 90 degree)



241 079 mm300 - Pz3

Multiutensile per estrarre modanature esterne

Trim tool for rubber doors



241 080 Universale

Giravite speciale per smontaggio maniglie portiere

Screwdriver for dismantling handle door



241 084 Mercedes classe A - Torx foro - T 20

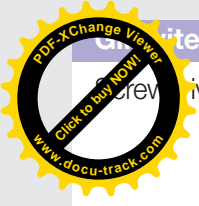

Chiave speciale per rivestimenti interni

Special key for dismantling internal panels



241 086 VW Lupo-Golf IV-Audi A3 - XZN 4

Chiave smontaggio specchietto retrovisore Fiat Punto

Key dismantlement small mirror Fiat Punto



241 095

Telo protezione carrozzeria con magnete interno di fissaggio



241 099 Una fascia magnetica - cm 60x90

241 099 01 Due fasce magnetiche - cm 60x90

Convogliatore di aria calda STEINEL a due velocità

STEINEL heat gun

1610S



241 101 01 220 Volt 50 Hz. - 1610S - 1600 Watt
Temperatura 300° C e 500° C
Portata aria 240 l/min e 450 l/min.
peso 550 Gr.

Convogliatore aria calda Steinel HL1910E elettronico

Regolazione Continua



241 102 01 230 Volt 50 Hz
4 Velocità
Temperatura 50-600°
Potenza 2000W
Portata aria 150-300-500 Lt/min

Convogliatore aria calda HG2000E

Hot air gun HG2000E

Regolazione Elettronica



241 103 230 Volt 50 Hz
Temperatura 100-600°
Potenza 2000W
Portata aria 350-550 Lt/min

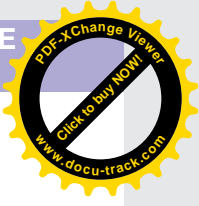

NOTE

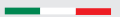

Blank lined area for notes.

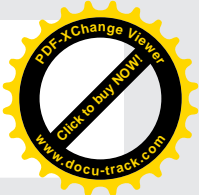
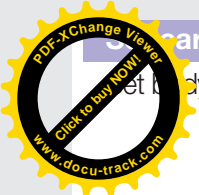

Set complete for shop HG2000E in plastic box



241 104 Set completo

Composizione - Composition

- 241 103 Convogliatore
- 241 104 02 Ugello piatto mm 75
- 241 104 03 Ugello riflettore
- 241 104 04 Ugello riduttore Ø9
- 241 104 05 Ugello riduttore Ø14
- 241 104 09 Ugello Tubi PVC
- 241 104 12 Stecca plastica HDPE
- 241 104 13 Stecca PVC rigido
- 241 104 15 Stecca LDPE
- 241 104 16 Stecca PP

Ricambi - Spare parts



- 241 104 01 Ugello piatto mm 50
- 241 104 02 Ugello piatto mm 75



241 104 03 Ugello riflettore



- 241 104 04 Ugello riduttore Ø 09
- 241 104 05 Ugello riduttore Ø 14
- 241 104 06 Ugello riduttore Ø 20



241 104 07 Ugello per saldare Ø 2



241 104 08 Ugello per saldare



241 104 09 Ugello per saldare tubi Ø 75



241 104 10 Ugello a riflettore



241 104 11 Ugello a gancio per saldare



241 104 12 Stecca HDPE

241 104 13 Stecca PVC rigido

241 104 14 Stecca PVC Plastif.

241 104 15 Stecca LDPE

241 104 16 Stecca PP

241 104 17 Stecca ABS



241 104 18 Set raschietti



241 104 19 Rullo a pressare

Rotella a pressare per saldature a filo



241 104 20

NOTE

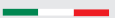

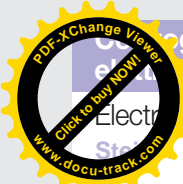

Convogliatore di aria calda con regolazione elettronica della temperatura e del volume dell'aria

Electronic hot air gun
Sternel HG 2310 LCD



241 105 Tensione 230V - 50Hz / Potenza 2300W

Caratteristiche tecniche:
Dimensioni : 260 x 90 x 205
Temperatura: Livello 1 - 50° Livello 2 - 50° - 650°.
Volume d'aria: Livello 1-150 - 250 l/min - Livello 2 - 250-500l/min
Programma 1 = 250° C / ca. 350 l / min
Programma 2 = 350° C / ca. 400 l / min
Programma 3 = 450° C / ca. 500 l / min
Programma 4 = 550° C / ca. 400 l / min
Ventilatore: a regolazione continua
Peso: Gr 940

Set riparazione componenti plastici delle vetture

Plastic repair kit for automotive industry

Ideale per riparazioni componenti plastici (tipo piccole crepe nei paraurti) senza doverli sostituire

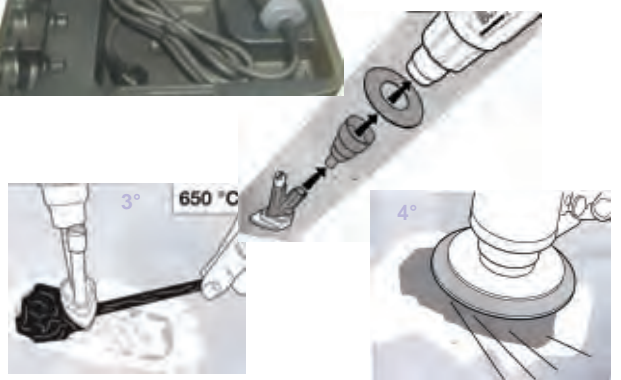
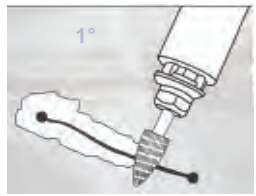

241 110 Kit completo con 10 fili di apporto + 5 tessuti metallici

Ricambi - Spare parts

- 241 105** Convogliatore di aria calda
- 241 104 09** Ugello riduttore Ø 9
- 241 110 01** 076467 - Filo di apporto speciale - Pz 20
- 241 110 02** 076566 - Tessuto metallico Pz 10
Zoccolo di saldatura non disponibile
- 241 110 05** 076665 - Anello di protezione

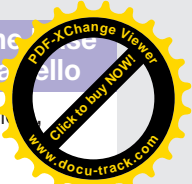

Espander idraulico per carrozzeria versione completa degli accessori raffigurati con carrello

Hidraulic expander for coachbuilders and workshop complete as in figure on drawer



241 401 Portata 12 Ton.
Corsa del pistone /Piston stroke / Medida piston 150 mm
Prolungamento massimo mediante tubi ed a fine corsa pistone 1800 mm
Misure 400x800x600h mm
Peso 45 Kg

Come 241 401 versione in bauletto

Same 241 401 Chest version



241 402

Espander idraulico per carrozzeria versione Completa, completo degli accessori raffigurati con carrello

Hidraulic expander for coachbuilders and workshop, complete as in figure on drawer



241 403 Portata 12 Ton.
Corsa del pistone 150 mm
Prolungamento massimo mediante tubi ed a fine corsa pistone 1800 mm
Misure 400x800x600h mm
Peso 55 Kg

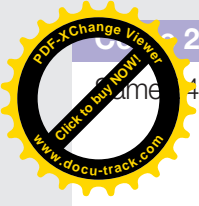

241 403 versione in bauletto

241 403 Chest version



241 404

Tassello per carrozzeria



241 499



241 502 01



241 507 01



241 507 02

| | | |
|------------|----------------------------|----------|
| 241 499 | Tassello a "C" | Gr. 1500 |
| 241 502 01 | Tassello a incudine | Gr. 1100 |
| 241 507 01 | Tassello piano, curva a Sx | Gr. 900 |
| 241 507 02 | Tassello piano, curva a Dx | Gr. 1200 |

Tassello per carrozzeria a virgola pesante

Curved dolly



241 500 1100 gr

Tassello per carrozzeria a incudine

Anvil dolly



241 501

Tassello per carrozzeria universale a battere bombato

Base dolly



241 502 950 gr

Tassello per carrozzeria a virgola leggero

Flat wedge dolly



241 503 950 gr

Tassello per carrozzeria a cuore

Heart dolly



241 504

Tassello per carrozzeria a teste piana e convessa



241 505 800 gr

Tassello per carrozzeria a rotaia

Small dolly



241 506 1000 gr

Tassello per carrozzeria piano e arrotondato

Toe dolly



241 507 1200 gr

Tassello per carrozzeria mezzaluna

Half moon dolly



241 508 850 gr

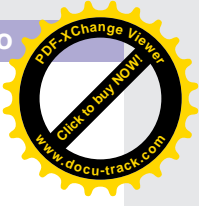



Tassello per carrozzeria quadro a testa doppia

Small dolly



241 510 50x50 - 35x35 - 620 gr

Tassello per carrozzeria a scalpello e testa tonda schiacciata

Small dolly



241 511 1000 gr

Tassello per carrozzeria a farfalla

Small dolly



241 512 450 gr

Tassello per carrozzeria piatto bombato

Small dolly



241 513 1200 gr

Tassello per carrozzeria a uovo

Small dolly



241 514 1400 gr

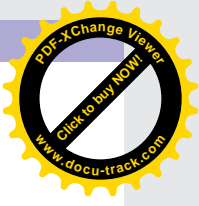

Tassello per carrozzeria piatto a battere

Small dolly



241 515 1200 gr

Leva per carrozzeria curva

Bent spoon



241 520 560 gr.

Leva per carrozzeria a cucchiaio

Narrow spoon



241 521 700 gr

Leva doppia per carrozzeria a cucchiaio

Double wide blade spoon



241 522 1000 gr

Leva a gola per carrozzeria

Wide blade spoon



241 523 1000 gr

Leva a due facce a gomito piegate per carrozzeria

Wide blade spoon



241 524 1000 gr

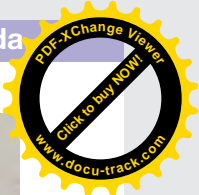
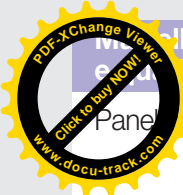

Martello per spianare testa striata tonda e tonda liscia

Panel beating hammer type bumping



241 529 700 gr.

Martello per spianare testa striata quadra e tonda liscia

Panel beating hammer type bumping



241 530 700 gr.

Martello per spianare testa a penna e tonda

Panel beating hammer type round and dinging head



241 531 320 gr.

Martello per spianare testa tonda piana e convessa

Panel beating hammer type round head



241 532 550 gr.

Martello per spianare testa semisferica

Panel beating hammer type spheric



241 533 610 gr.

Martello per spianare testa penna e tonda

Panel beating hammer type pencil and round



241 534 630 gr.

Martello per spianare testa quadra e tonda bombata

Panel beating hammer type pencil and round



241 535 460 gr.

Martello per spianare



241 535 01
241 535 02

| | Testa quadra piatta | Testa tonda bombata | Gr. |
|------------|------------------------------|------------------------|-----|
| 241 535 01 | mm 29 | mm30 | 500 |
| | Testa rettangolare piatta | Testa tonda piatta | Gr. |
| 241 535 02 | mm 25 x 27 | mm 32 | 300 |

Portalime

File holder



241 536

241 537 Lima ricambio

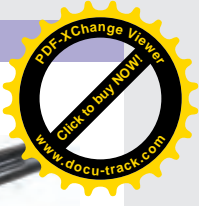
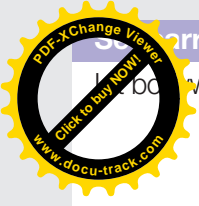

Carrozziere

work



241 550 Cont. 241 505/506/507/508/512/532
417 001 - 7 pcs

Set carrozziere

Kit bodywork



241 552 Cont 241 501/513/514/515/524/534/535/536
417 434 e 4 lame flessibili - 10 pcs

Pinza foralamiere

Punch plier for panel



- 241 600 03** Per lamiera Max mm 1 Ø 3
- 241 600 04** Per lamiera Max mm 1 Ø 4
- 241 600 05** Per lamiera Max mm 1 Ø 5
- 241 600 06** Per lamiera Max mm 1 Ø 6
- 241 600 08** Per lamiera Max mm 0,8 Ø 8

Ricambi - Spare parts

- 241 600 13** Punzone + Matrice per 241 60003 Ø 3
- 241 600 14** Punzone + Matrice per 241 60004 Ø 4
- 241 600 15** Punzone + Matrice per 241 60005 Ø 5
- 241 600 16** Punzone + Matrice per 241 60006 Ø 6
- 241 600 18** Punzone + Matrice per 241 60008 Ø 8

NOTE



Pinza foralamiere - Ø8

Punch plier for panel

Per lamiere in acciaio
in coppia (0,7x2)
max mm1,4

Per lamiere
in acciaio singole
max mm1,2



mm 260

241 605 Kg 0,8

Dati tecnici - Informative

Corpo in acciaio - Impugnatura rivestita in gomma -
Punzone in Ni-Cr-Mo sostituibile e riaffilabile

Pinza fora lamiere con asola

Punch plier for panel with slot



241 608 Ideale per Vw - Audi

Dati tecnici - Informative

- * Misura: L 220 x 100 mm
- * Max.sp = 0.8 mm FE
- * Asola mis = 4 x 8 mm
- * Peso: gr 350

Pinza bordatrice per lamiere

Coachbuilder's panel-crimping plier



241 610

NOTE

